



U74LVC1G04

CMOS IC

SINGLE INVERTER GATE

DESCRIPTION

The UTC **U74LVC1G04** is a single inverter gate, it provides the function $Y = \bar{A}$.

This device has power-down protective circuit, preventing device destruction when it is powered down.

FEATURES

- * Operation voltage range: 1.65~5.5V
- * Low power current: $I_{CC}=10\mu A(\text{Max})$
- * 24mA output drive ($V_{CC}=3.3V$)
- * High noise immunity
- * Power down protection

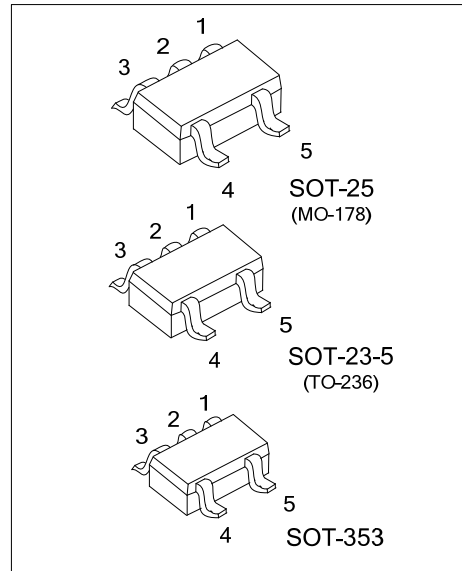

ORDERING INFORMATION

Ordering Number		Package	Packing
Lead Free	Halogen Free		
U74LVC1G04L-AE5-R	U74LVC1G04G-AE5-R	SOT-23-5	Tape Reel
U74LVC1G04L-AF5-R	U74LVC1G04G-AF5-R	SOT-25	Tape Reel
U74LVC1G04L-AL5-R	U74LVC1G04G-AL5-R	SOT-353	Tape Reel

<p>U74LVC1G04L-AF5-R</p> <p>(1) Packing Type (2) Package Type (3) Lead Free</p>	<p>(1) R: Tape Reel (2) AE5: SOT-23-5, AF5: SOT-25, AL5: SOT-353 (3) G: Halogen Free, L: Lead Free</p>
---	--

MARKING

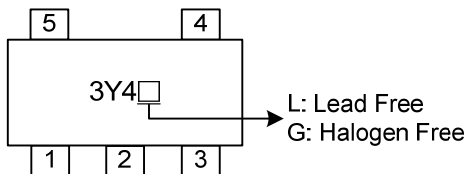

■ PIN CONFIGURATION

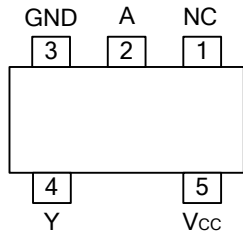

■ FUNCTION TABLE (each gate)

INPUT	OUTPUT
A	Y
H	L
L	H

■ LOGIC DIAGRAM (positive logic)

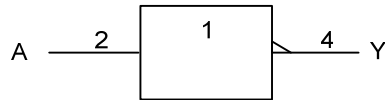
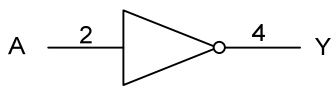

■ ABSOLUTE MAXIMUM RATINGS (unless otherwise specified)(Note 2)

PARAMETER	SYMBOL	RATINGS	UNIT
Supply Voltage	V_{CC}	-0.5~6.5	V
Input Voltage	V_{IN}	-0.5~6.5	V
Output Voltage(Active Mode)	V_{OUT}	-0.5~ $V_{CC}+0.5$	V
Output Voltage(Power-Down Mode)	V_{OUT}	-0.5~6.5	V
Input Clamp Current($V_{IN}<0$)	I_{IK}	-50	mA
Output Clamp Current($V_{OUT}<0$)	I_{OK}	-50	mA
Output Current	I_{OUT}	± 50	mA
V_{CC} or GND Current	I_{CC}	± 100	mA
Storage Temperature	T_{STG}	-65 ~ +150	$^{\circ}C$

Notes: 1. Absolute maximum ratings are those values beyond which the device could be permanently damaged.

Absolute maximum ratings are stress ratings only and functional device operation is not implied.

2. The input and output voltage ratings may be exceeded if the input and output current ratings are observed.

■ RECOMMENDED OPERATING CONDITIONS

PARAMETER	SYMBOL	CONDITIONS	MIN	TYP	MAX	UNIT
Supply Voltage	V_{CC}	Operating	1.65		5.5	V
		Data retention only	1.5			
Input Voltage	V_{IN}		0		5.5	V
Output Voltage	V_{OUT}		0		V_{CC}	V
Input Transition Rise or Fall Rate	t_R, t_F	$V_{CC} = 1.8V \pm 0.15V, 2.5V \pm 0.2V$			20	ns/V
		$V_{CC} = 3.3V \pm 0.3V$			10	ns/V
		$V_{CC} = 5V \pm 0.5V$			5	ns/V
Operating Temperature	T_A		-40		85	

■ STATIC CHARACTERISTICS

PARAMETER	SYMBOL	TEST CONDITIONS	MIN	TYP	MAX	UNIT
Input Voltage High-Level	V_{IH}	$V_{CC} = 1.65V \sim 1.95V$	$0.65 \times V_{CC}$			V
		$V_{CC} = 2.3V \sim 2.7V$	1.7			
		$V_{CC} = 2.7V \sim 3.6V$	2			
		$V_{CC} = 4.5V \sim 5.5V$	$0.7 \times V_{CC}$			
Input Voltage Low-Level	V_{IL}	$V_{CC} = 1.65V \sim 1.95V$			$0.35 \times V_{CC}$	V
		$V_{CC} = 2.3V \sim 2.7V$			0.7	
		$V_{CC} = 2.7V \sim 3.6V$			0.8	
		$V_{CC} = 4.5V \sim 5.5V$			$0.3 \times V_{CC}$	
Output Voltage High-Level	V_{OH}	$V_{CC} = 1.65V \sim 5.5V, I_{OH} = -100\mu A$	$V_{CC} - 0.1$			V
		$V_{CC} = 1.65V, I_{OH} = -4mA$	1.2			
		$V_{CC} = 2.3V, I_{OH} = -8mA$	1.9			
		$V_{CC} = 3V, I_{OH} = -16mA$	2.4			
		$V_{CC} = 3V, I_{OH} = -24mA$	2.3			
Output Voltage Low-Level	V_{OL}	$V_{CC} = 1.65V \sim 5.5V, I_{OL} = 100\mu A$			0.1	V
		$V_{CC} = 1.65V, I_{OL} = 4mA$			0.45	
		$V_{CC} = 2.3V, I_{OL} = 8mA$			0.3	
		$V_{CC} = 3V, I_{OL} = 16mA$			0.4	
		$V_{CC} = 3V, I_{OL} = 24mA$			0.55	
Input Leakage Current	$I_{I(LEAK)}$	$V_{CC} = 0 \sim 5.5V, V_{IN} = 5.5V$ or GND			± 5	μA

■ STATIC CHARACTERISTICS(Cont.)

PARAMETER	SYMBOL	TEST CONDITIONS	MIN	TYP	MAX	UNIT
Power OFF Leakage Current	I_{OFF}	$V_{CC} = 0V, V_{IN}$ or $V_{OUT} = 5.5V$			± 10	μA
Quiescent Supply Current	I_Q	$V_{CC} = 1.65V \sim 5.5V, V_{IN} = 5.5$ or GND, $I_{OUT} = 0$			10	μA
Additional Quiescent Supply Current	ΔI_Q	$V_{CC} = 3V \sim 5.5V$, One input at $V_{CC} - 0.6V$, other inputs at V_{CC} or GND			500	μA
Input Capacitance	C_{IN}	$V_{CC} = 3.3V, V_{IN} = V_{CC}$ or GND		3.5		pF

■ DYNAMIC CHARACTERISTICS

PARAMETER	SYMBOL	TEST CONDITIONS	MIN	TYP	MAX	UNIT
Propagation Delay From Input (A or B) to Output (Y)	t_{PLH}/t_{PHL}	$V_{CC} = 1.8V \pm 0.15V, C_L = 15$ pF	2		6.4	ns
		$V_{CC} = 2.5V \pm 0.2V, C_L = 15$ pF	1		4.2	ns
		$V_{CC} = 3.3V \pm 0.3V, C_L = 15$ pF	0.7		3.3	ns
		$V_{CC} = 5V \pm 0.5V, C_L = 15$ pF	0.7		3.1	ns
		$V_{CC} = 1.8V \pm 0.15V, C_L = 30$ or 50 pF	3		7.5	ns
		$V_{CC} = 2.5V \pm 0.2V, C_L = 30$ or 50 pF	1.4		5.2	ns
		$V_{CC} = 3.3V \pm 0.3V, C_L = 30$ or 50 pF	1		4.2	ns
		$V_{CC} = 5V \pm 0.5V, C_L = 30$ or 50 pF	1		3.7	ns

■ OPERATING CHARACTERISTICS

PARAMETER	SYMBOL	TEST CONDITIONS	MIN	TYP	MAX	UNIT
Power Dissipation Capacitance	C_{PD}	$V_{CC} = 1.8V, f = 10$ MHz		16		pF
		$V_{CC} = 2.5V, f = 10$ MHz		18		pF
		$V_{CC} = 3.3V, f = 10$ MHz		18		pF
		$V_{CC} = 5V, f = 10$ MHz		20		pF

■ TEST CIRCUIT AND WAVEFORMS

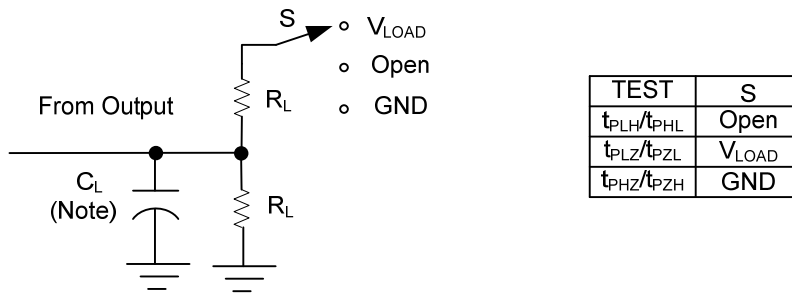

Note: C_L includes probe and jig capacitance.

V_{CC}	V_{IN}	t_R, t_F	V_M	V_{LOAD}	C_L	R_L	V
$1.8V \pm 0.15V$	V_{CC}	$\leq 2ns$	$V_{CC}/2$	$2 \times V_{CC}$	15pF	1M Ω	0.15V
$2.5V \pm 0.2V$	V_{CC}	$\leq 2ns$	$V_{CC}/2$	$2 \times V_{CC}$	15pF	1M Ω	0.15V
$3.3V \pm 0.3V$	3 V	$\leq 2.5ns$	1.5V	6V	15pF	1M Ω	0.3V
$5V \pm 0.5V$	V_{CC}	$\leq 2.5ns$	$V_{CC}/2$	$2 \times V_{CC}$	15pF	1M Ω	0.3V
$1.8V \pm 0.15V$	V_{CC}	$\leq 2ns$	$V_{CC}/2$	$2 \times V_{CC}$	30pF	1k Ω	0.15V
$2.5V \pm 0.2V$	V_{CC}	$\leq 2ns$	$V_{CC}/2$	$2 \times V_{CC}$	30pF	500 Ω	0.15V
$3.3V \pm 0.3V$	3 V	$\leq 2.5ns$	1.5V	6V	50pF	500 Ω	0.3V
$5V \pm 0.5V$	V_{CC}	$\leq 2.5ns$	$V_{CC}/2$	$2 \times V_{CC}$	50pF	500 Ω	0.3V

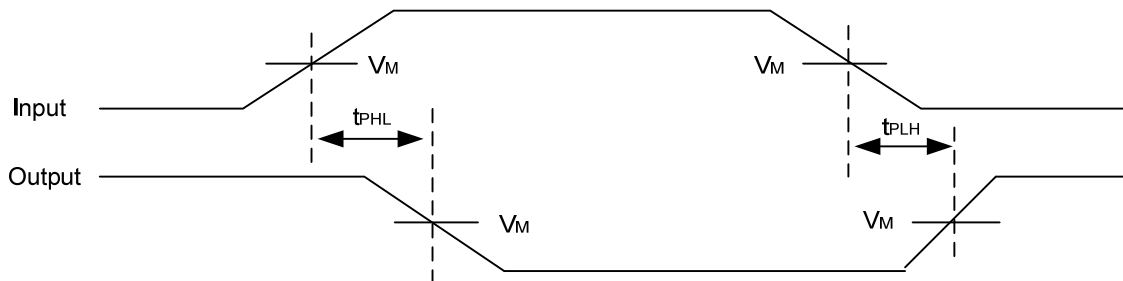

UTC assumes no responsibility for equipment failures that result from using products at values that exceed, even momentarily, rated values (such as maximum ratings, operating condition ranges, or other parameters) listed in products specifications of any and all UTC products described or contained herein. UTC products are not designed for use in life support appliances, devices or systems where malfunction of these products can be reasonably expected to result in personal injury. Reproduction in whole or in part is prohibited without the prior written consent of the copyright owner. The information presented in this document does not form part of any quotation or contract, is believed to be accurate and reliable and may be changed without notice.