

## ISOLATED DC/DC CONVERTERS

18 Vdc - 75 Vdc Input, 12 Vdc/3.5 A Output



Apr. 19, 2011

*Bel Power, Inc. , a subsidiary of Bel Fuse, Inc.*

**0RSB-40U12B RoHS Compliant PRELIMINARY Rev.A**

### Features

- Isolated
- High Efficiency
- Fixed Frequency
- High Power Density
- Low Cost
- Input Under-voltage Lockout
- Output Voltage Trim
- Class 1, Category 2, Isolated DC/DC Converter (refer to IPC-9592)
- Output Over-voltage Shut Down
- Over Temperature Protection
- OCP/SCP
- Remote ON/OFF
- Positive/Negative Remote Sense
- Basic Insulation

### Applications

- Networking
- Computers and peripherals
- Telecommunications

### Description

The 0RSB-40U12B series is isolated dc/dc converter that operates from a nominal 24 Vdc or 48 Vdc source. These units will provide up to 42 W of output power from an 18 - 75 Vdc wide input range. These units are designed to be highly efficient and low cost. Features include remote on/off, over current protection and under voltage lockout. These converters are provided in an industry standard sixteenth brick package.

### Part Selection

Output Voltage	Input Voltage	Max. Output Current	Max. Output Power	Typical Efficiency	Model Number Active Low
12 Vdc	18 Vdc - 75 Vdc	3.5 A	42 W	85%	0RSB-40U12B

**Notes:** Add "G" suffix at the end of the model number to indicate Tray Packaging.

### Part Number Explanation

0 R SB - 40 U 12 B  
1 2 3 4 5 6 7

1---Through hole mount

2---RoHS 6, change "R" to "7" means RoHS 5

3---Series name, 1/16 Brick

4---Series code

5---Input range (18-75V)

6---Output voltage (12V)

7---Option, "x" of the model part number to be 0-9, A-Z, which will represent the special request of customer.

# ISOLATED DC/DC CONVERTERS

18 Vdc - 75 Vdc Input, 12 Vdc/3.5 A Output



Apr. 19, 2011

Bel Power, Inc., a subsidiary of Bel Fuse, Inc.

## Absolute Maximum Ratings

Parameter	Min	Typ	Max	Unit	Notes
Continuous Input Voltage	-0.3	-	80	V	
Input Transient Voltage	-	-	100	V	100mS maximum
Remote On/Off	-0.3	-	18	V	
I/O isolation voltage	-	-	1500	V	
Ambient Temperature	-40	-	85	°C	
Storage Temperature	-55	-	125	°C	

**Note:** Ratings used beyond the maximum ratings may cause a reliability degradation of the converter or may permanently damage the device.

## Input Specifications

Parameter	Min	Typ	Max	Unit	Notes
Operating Input Voltage	18	48	75	V	
Input Current (full load)	-	-	3.5	A	
Input Current (no load)	-	60	120	mA	
Remote Off Input Current	-	1	3	mA	
Input Reflected Ripple Current (rms)	-	3	7	mA	With simulated source impedance of 15uH, 5Hz to 20MHz. Use a 100uF/100V electrolytic capacitor with ESR=1 ohm max, at 200KHz@25°C.
Input Reflected Ripple Current (pk-pk)	-	20	50	mA	
I <sup>2</sup> t Inrush Current Transient	-	0.01	0.02	A <sup>2</sup> s	
Input Over Voltage Lockout	78	-	82	V	
Turn-on Voltage Threshold	16.6	17.2	17.8	V	
Turn-off Voltage Threshold	16.2	16.8	17.4	V	

**Note:** All specifications are typical at 25 °C unless otherwise stated.

## Output Specifications

Parameter	Min	Typ	Max	Unit	Notes
Output Voltage Set Point	11.75	12	12.25	V	Vin=48V, Io=50% load
Load Regulation	-	±9	±18	mV	
Line Regulation	-	±6	±15	mV	
Regulation Over Temperature (-40deg.C-85deg.C)	-	±20	±35	mV	
Output Ripple and Noise (pk-pk)	-	90	180	mV	0-20MHz BW, with a 1µF ceramic capacitor and a 10uF Tantalum cap at output.
Output Ripple and Noise (rms)	-	30	55	mV	
Output Current Range	0	-	3.5	A	
Output DC Current Limit	3.7	5	6	A	Hiccup mode, auto recovery
Short Circuit Surge Transien	-	0.5	1	A <sup>2</sup> s	
Turn on Time	-	25	50	mS	

# ISOLATED DC/DC CONVERTERS

18 Vdc - 75 Vdc Input, 12 Vdc/3.5 A Output



Apr. 19, 2011

*Bel Power, Inc., a subsidiary of Bel Fuse, Inc.*

## Output Specifications (continued)

Parameter	Min	Typ	Max	Unit	Notes	
Overshoot at Turn on	-	0	5	%		
Output Capacitance	10	-	220	uF		
<b>Transient Response</b>						
$\Delta V$ 25%~50% of Max Load	Overshoot	-	400	650	mV	$di/dt=0.1A/us$ , $V_{in}=48Vdc$ , $T_a=25^{\circ}C$ , with a $1\mu F$ ceramic capacitor and a 10uF Tantalum cap at output.
	Settling Time	-	150	300	uS	
$\Delta V$ 50%~25% of Max Load	Overshoot	-	400	650	mV	
	Settling Time	-	150	300	uS	

**Note:** All specifications are typical at nominal input, full load at 25°C unless otherwise stated.

## General Specifications

Parameter	Min	Typ	Max	Unit	Notes
Efficiency	83	85	-	%	$V_{in}=48V$ , full load
Switching Frequency	-	500	-	kHz	
Over Temperature Protection	-	125	-	°C	The OTP threshold is set at 125°C in non-latch mode, and the module will restart automatically when temperature falls down to 115°C.
Over Voltage Protection(Static)	-	130	160	%	This voltage is achieved by trimming up output slowly.
Weight	-	14	-	g	
Dimensions				-	
Inches (L x W x H)	1.30 x 0.90 x 0.46				
Millimeters (L x W x H)	33.02 x 22.86 x 11.69				
<b>Isolation characteristics</b>					
Input to Output	-	-	1500	V	
Isolation Resistance	10M	-	-	Ohm	
Isolation Capacitance	-	3900	-	pF	

**Note:** All specifications are typical at 25 °C unless otherwise stated.

# ISOLATED DC/DC CONVERTERS

18 Vdc - 75 Vdc Input, 12 Vdc/3.5 A Output



Apr. 19, 2011

Bel Power, Inc., a subsidiary of Bel Fuse, Inc.

## Efficiency Data

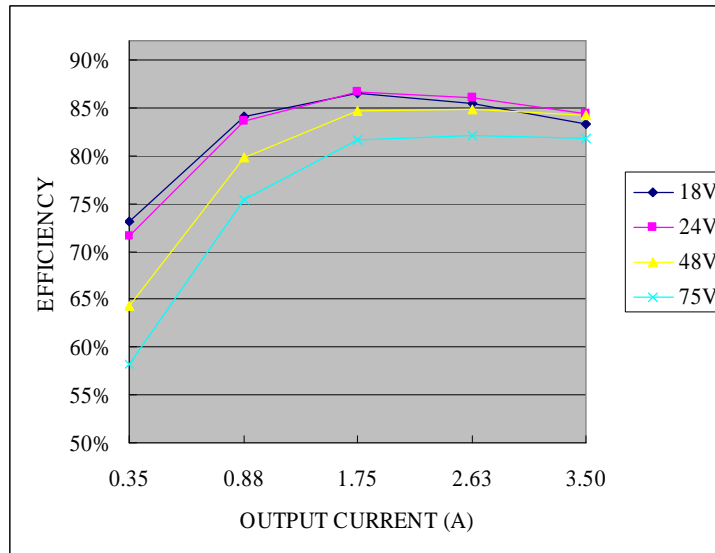

## Remote On/Off

Parameter	Min	Typ	Max	Unit	Notes
Signal Low (Unit On)	Active Low	-	0.8	V	Remote on/off pin open, Unit off.
Signal High (Unit Off)					
Current Sink	0	-	1	mA	

### Recommended remote on/off circuit for active low

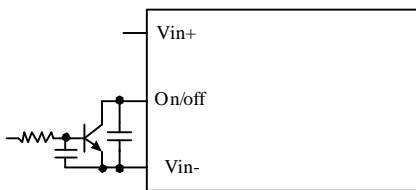

Control with open collector/drain circuit

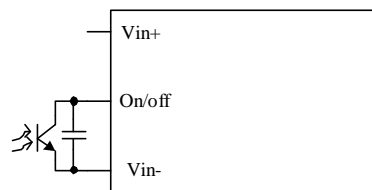

Control with photocoupler circuit

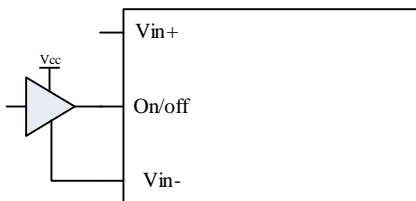

Control with logic circuit

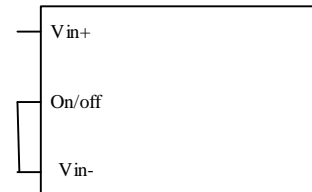

Permanently on

# ISOLATED DC/DC CONVERTERS

18 Vdc - 75 Vdc Input, 12 Vdc/3.5 A Output



Apr. 19, 2011

Bel Power, Inc., a subsidiary of Bel Fuse, Inc.

## Thermal Derating Curve

Maximum junction temperature of semiconductors derated to 120 degree C.

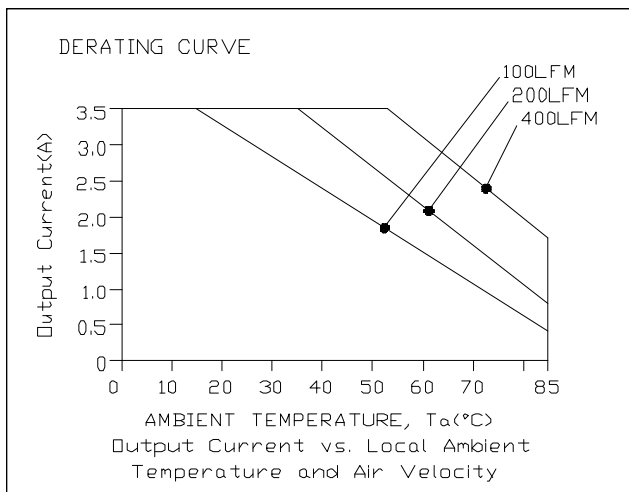
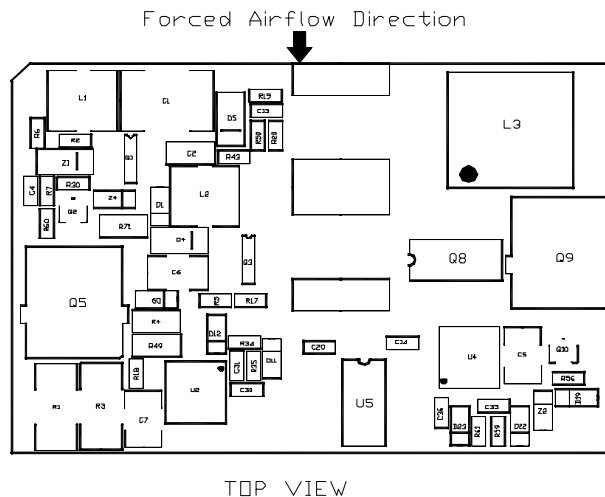

Vin=24V

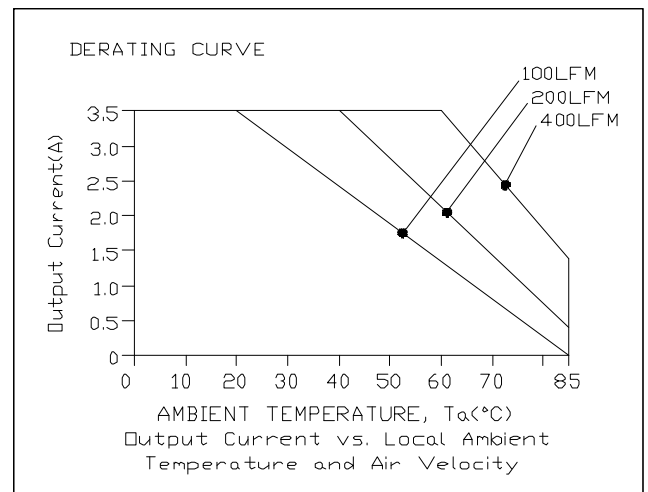

Vin=48V

# ISOLATED DC/DC CONVERTERS

18 Vdc - 75 Vdc Input, 12 Vdc/3.5 A Output



Apr. 19, 2011

Bel Power, Inc., a subsidiary of Bel Fuse, Inc.

## Thermal Derating Curve (continued)

The OTP is achieved by thermistor R65 and it is in non-latch mode when the hottest component Q5 reaches 130°C with 100LFM air flow correspondingly. It will restart automatically when the temperature falls down to 110°C. The protecting point will be varied a little under different conditions (air flow, ambient temperature, input voltage, load...).

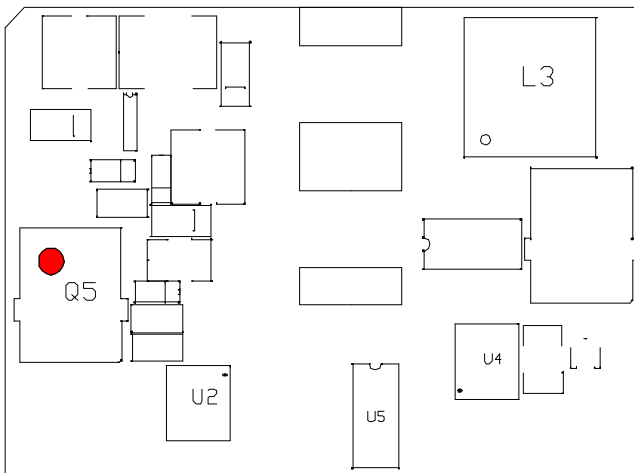

Temperature reference points on top side

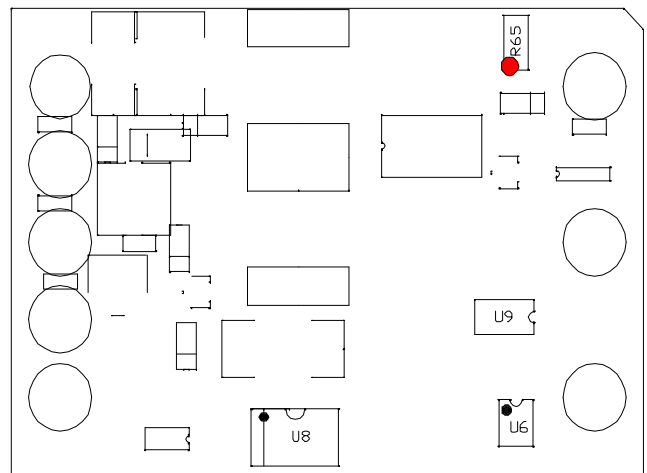

Temperature reference points on bottom side

## Ripple and Noise Waveform

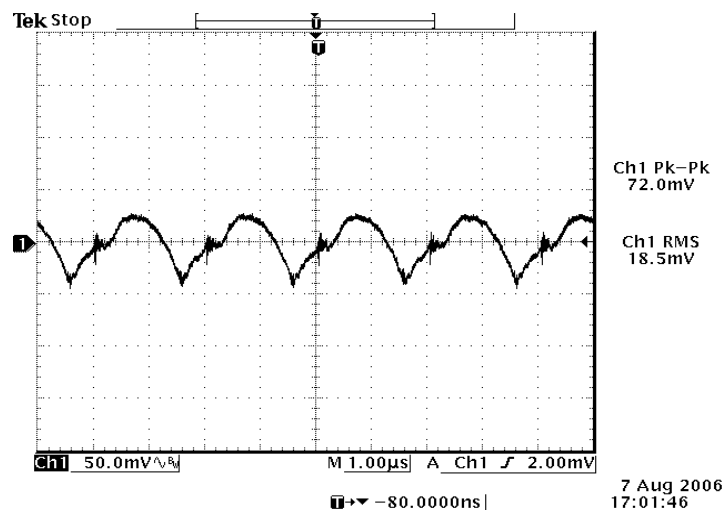

48Vdc input, 12Vdc output

**Note:** Ripple and noise at full load, with a 1uF ceramic cap and a 10 uF Tantalum cap at output, Ta=25 deg C.

# ISOLATED DC/DC CONVERTERS

18 Vdc - 75 Vdc Input, 12 Vdc/3.5 A Output



Apr. 19, 2011

Bel Power, Inc., a subsidiary of Bel Fuse, Inc.

## Transient Response Waveforms

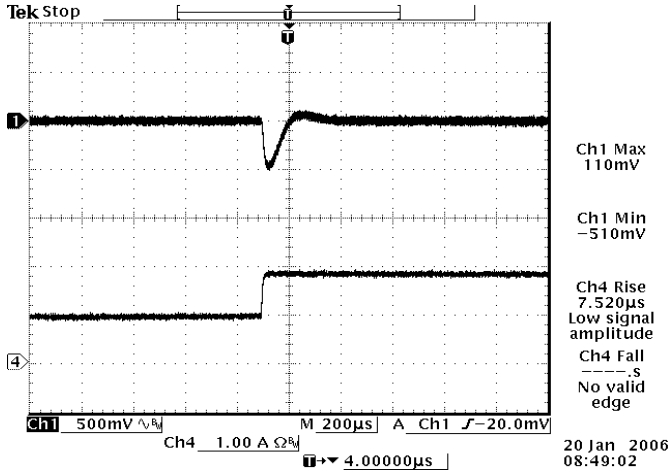

Vout= 12V 25%-50% Load Transients

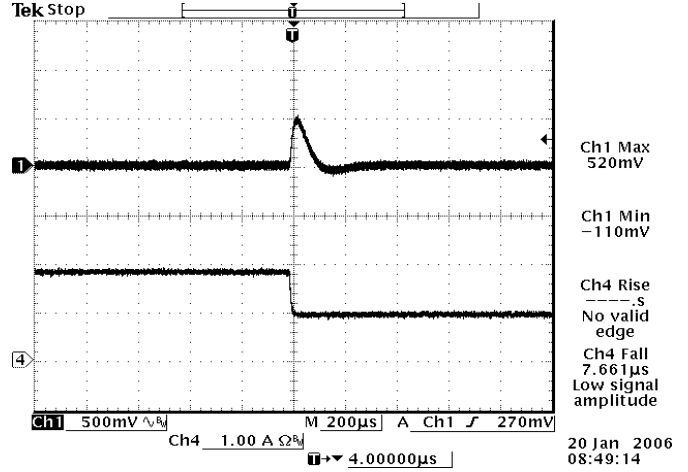

Vout= 12V 50%-25% Load Transients

**Note:** Transient Response at Vin=48V, di/dt=0.1A/uS, with External 10uF Tantalum Cap and 1uF Ceramic Cap at the output, Ta=25 deg C.

## Startup & Shutdown

### Rise Time

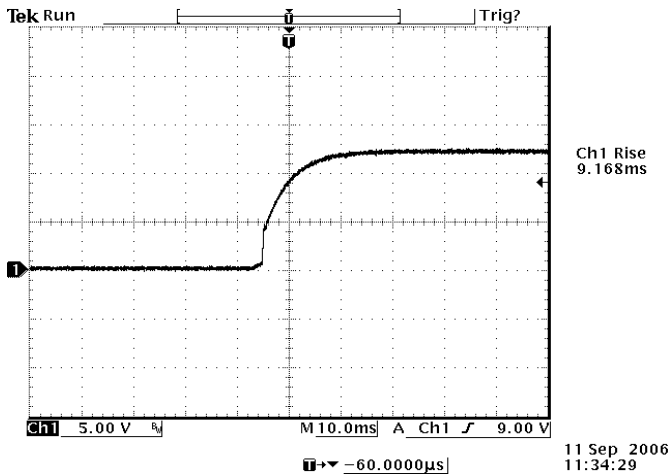

Vin=48V, Vout=12V, 100% Load

### Startup time

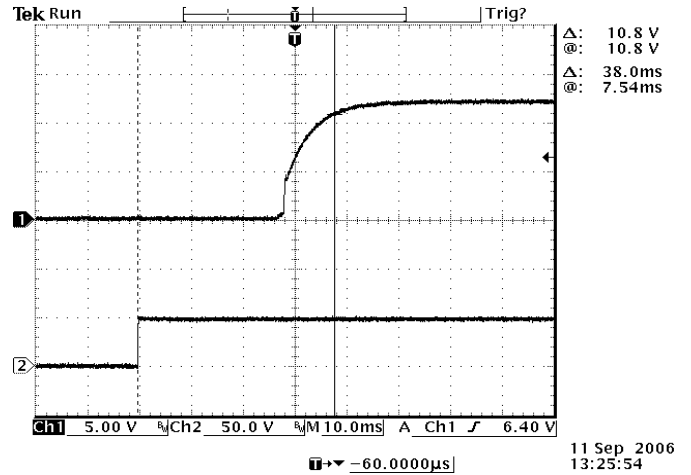

Startup from Vin  
Ch1: Vout  
Ch2: Vin  
Vin=48V, Vout=12V, 100% Load

# ISOLATED DC/DC CONVERTERS

18 Vdc - 75 Vdc Input, 12 Vdc/3.5 A Output



Apr. 19, 2011

Bel Power, Inc., a subsidiary of Bel Fuse, Inc.

## Output Trim Equations

Equations for calculating the trim resistor are shown below. The Trim Down resistor should be connected between the Trim pin and Ground pin. The Trim Up resistor should be connected between the Trim pin and the Vout. Only one of the resistors should be used for any given application.

$$R_{trimdown} = \frac{511}{|\delta|} - 10.22 [k\Omega]$$

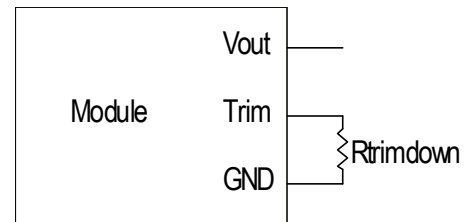

$$R_{trimup} = \frac{(100 + \delta) \cdot V_o \cdot 5.11 - 626}{1.225 \cdot \delta} - 10.22 [k\Omega]$$

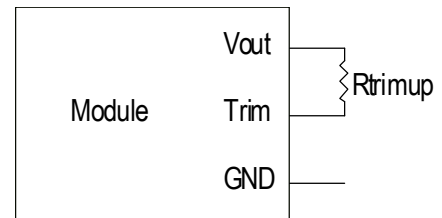

**Note:**  $\delta = \frac{(V_o_{req} - V_o)}{V_o} \times 100 [\%]$

$V_o_{req}$  = Desired (trimmed) output voltage [V]  
 Output voltage  $V_o$  = 12.007 V

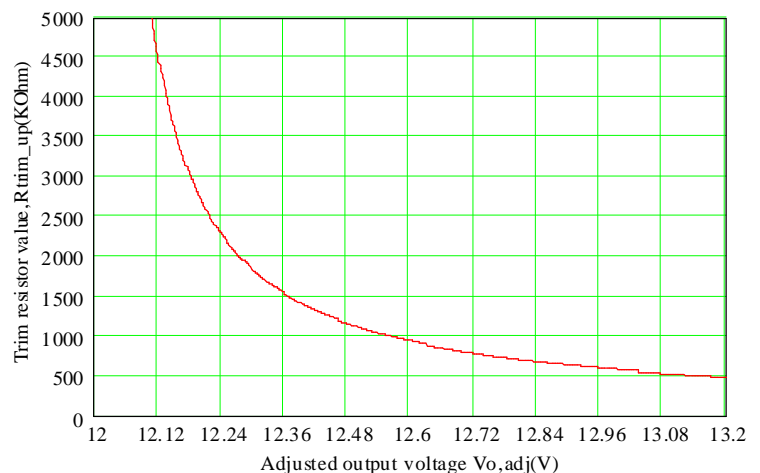
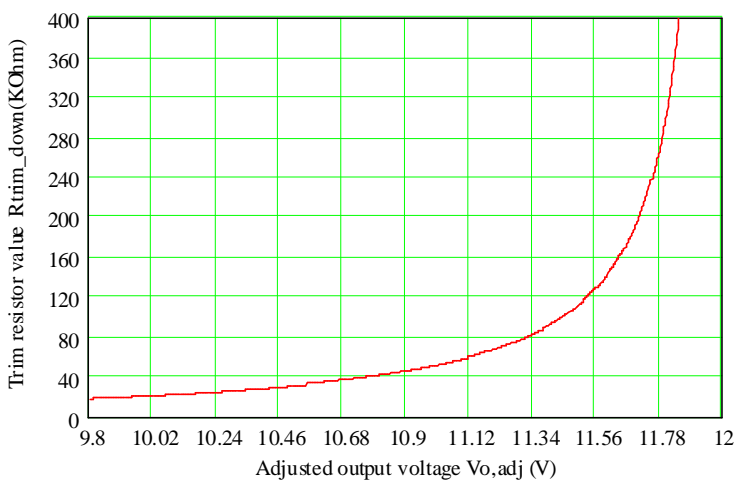



## ISOLATED DC/DC CONVERTERS

18 Vdc - 75 Vdc Input, 12 Vdc/3.5 A Output

**bel**

Apr. 19, 2011

*Bel Power, Inc. , a subsidiary of Bel Fuse, Inc.*

### Remote Sense

This module has remote sense compensation feature. It can minimize the effects of resistance between module's output and load in system layout and facilitates accurate voltage regulation at load terminals or other selected point.

1. The remote sense lines carries very little current and hence do not require a large cross-sectional area.
2. This module compensates for a maximum drop of 10% of the nominal output voltage.
3. If the unit is already trimmed up, the available remote sense compensation range should be correspondingly reduced. The total voltage increased by trim and remote sense should not exceed 10% of the nominal output voltage.
4. When using remote sense compensation, all the resistance, parasitic inductance and capacitance of the system are incorporated within the feedback loop of this module. It can make an effect on the module's compensation, affecting the stability and dynamic response. A 0.1uF ceramic capacitor can be connected at the point of load to de-couple noise on the sense wires.
5. Recommend the connection of remote sense compensation as below figure. There are a resistor RS+ (100 ohm) from Vo+ to Sense+ and a resistor RS- (51 ohm) from Vo- to Sense- inside of this module.

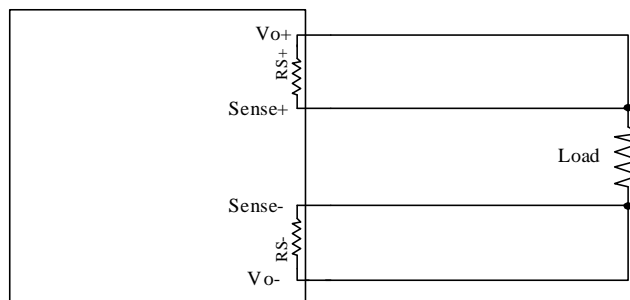

6. If not using remote sense compensation, please connect sense directly to output at module's pin, that is, connect sense+ to Vo+ and sense- to Vo- at module's pin, the shorter the better. See below figure.

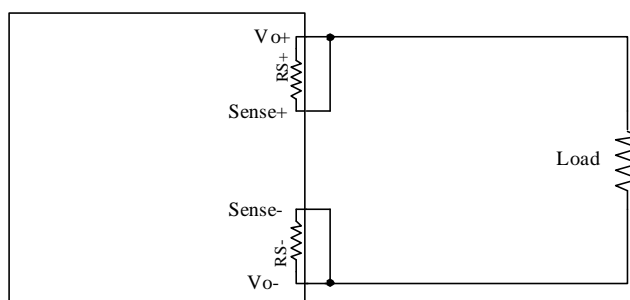

# ISOLATED DC/DC CONVERTERS

18 Vdc - 75 Vdc Input, 12 Vdc/3.5 A Output



Apr. 19, 2011

Bel Power, Inc., a subsidiary of Bel Fuse, Inc.

## Over Current Protection

To provide protection in a fault output overload condition, the module is equipped with internal current-limiting circuitry and can endure current limiting for a few milli-seconds. If the over current condition persists beyond a few milliseconds, the module will shut down into hiccup mode and restart once every 400mS. The module operates normally when the output current goes into specified range. The typical average output current is 0.5A during hiccup.

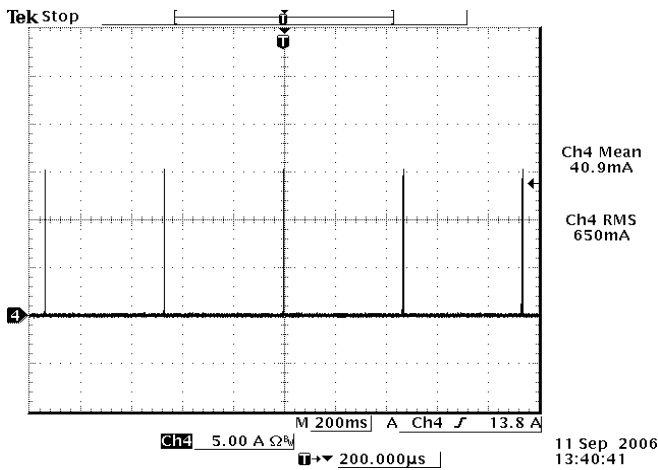

Vin=48V

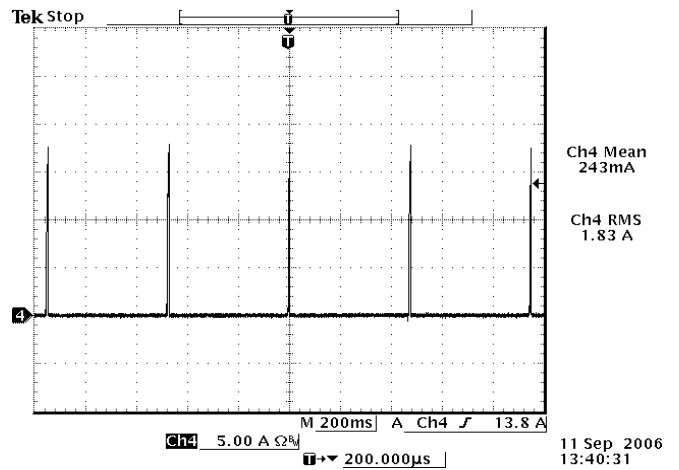

Vin=24V

## Input Under-voltage Lockout

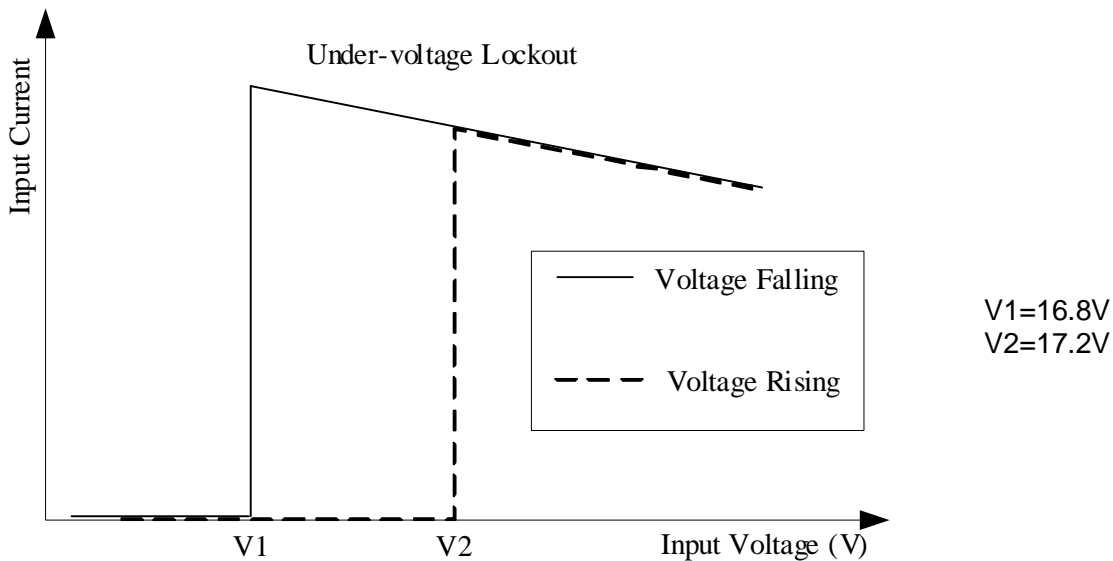

# ISOLATED DC/DC CONVERTERS

18 Vdc - 75 Vdc Input, 12 Vdc/3.5 A Output



Apr. 19, 2011

Bel Power, Inc., a subsidiary of Bel Fuse, Inc.

## Mechanical Outline

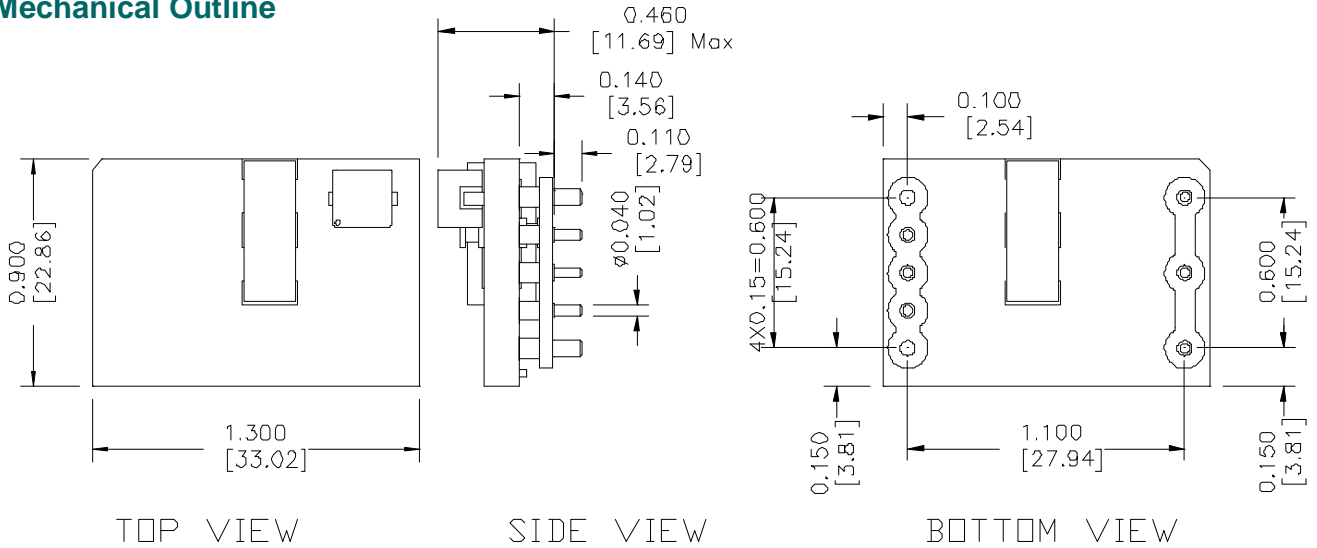

UNIT : INCH [mm]

## RECOMMENDED PCB PAD LAYOUT

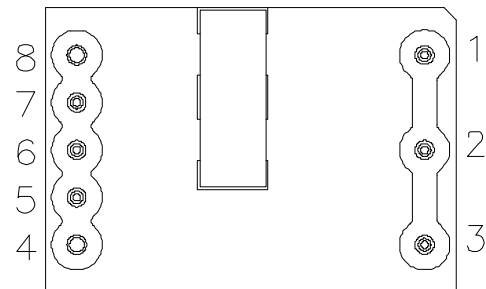
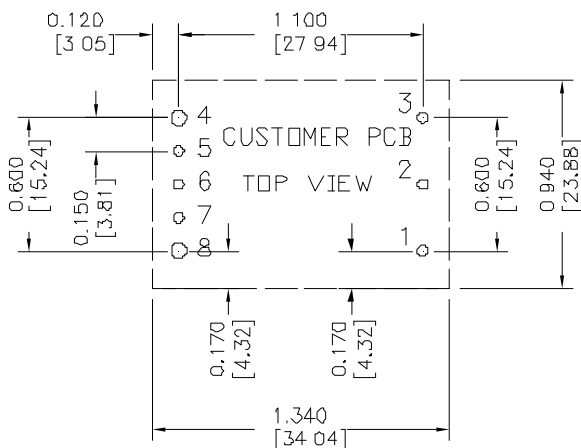

BOTTOM VIEW

HOLE SIZE: 1-3, 5-7  $\phi 0.047$  [1.19],  
 4,8  $\phi 0.07$  [1.78]  
 PAD SIZE: 1-3, 5-7  $\phi 0.08$  [2.03]  
 4,8  $\phi 0.10$  [2.54]

Pin	Function	Dia.	Pin	Function	Dia.
1	Vin(+)	0.04"	5	SENSE(-)	0.04"
2	On/Off	0.04"	6	TRIM	0.04"
3	Vin(-)	0.04"	7	SENSE(+)	0.04"
4	Vout(-)	0.062"	8	Vout(+)	0.062"

**Note:** This module is recommended and compatible with Pb-Free Wave Soldering and must be soldered using a peak solder temperature of no more than 260 °C for less than 5 seconds.

### Note:

- 1) All Pins: Material - Copper Alloy;  
Finish – 3 micro inches minimum Gold over 50 micro inches minimum Nickel plate.
- 2) Undimensioned components are shown for visual reference only.
- 3) All dimensions in inches (mm); Tolerances: x.xx +/-0.02 in. (x.x +/-0.5mm) x.xxx +/-0.010 in. (x.xx +/-0.25mm).

# ISOLATED DC/DC CONVERTERS

18 Vdc - 75 Vdc Input, 12 Vdc/3.5 A Output



Apr. 19, 2011

*Bel Power, Inc., a subsidiary of Bel Fuse, Inc.*

## Revision History

Date	Revision	Changes Detail	Approval
2011-04-19	PA	First release	JZ Wang

### RoHS Compliance

Complies with the European Directive 2002/95/EC, calling for the elimination of lead and other hazardous substances from electronic products.



©2011 Bel Fuse Inc. Specifications subject to change without notice. 041911

12

#### CORPORATE

**Bel Fuse Inc.**  
206 Van Vorst Street  
Jersey City, NJ 07302  
Tel 201-432-0463  
Fax 201-432-9542  
[www.belfuse.com](http://www.belfuse.com)

#### FAR EAST

**Bel Fuse Ltd.**  
8F/ 8 Luk Hop Street  
San Po Kong  
Kowloon, Hong Kong  
Tel 852-2328-5515  
Fax 852-2352-3706  
[www.belfuse.com](http://www.belfuse.com)

#### EUROPE

**Bel Fuse Europe Ltd.**  
Preston Technology Management Centre  
Marsh Lane, Suite G7, Preston  
Lancashire, PR1 8UD, U.K.  
Tel 44-1772-556601  
Fax 44-1772-888366  
[www.belfuse.com](http://www.belfuse.com)