

High-Voltage, High-Current Darlington Transistor Arrays

GENERAL DESCRIPTION

The XR-2201, XR-2202, XR-2203, and XR-2204 Darlington transistor arrays are comprised of seven silicon NPN Darlington pairs on a single monolithic substrate. All units feature open-collector outputs and integral protection diodes for driving inductive loads. Peak inrush currents of up to 600 mA are allowable, making them also ideal for driving tungsten filament lamps. Although the maximum continuous collector current rating is 500mA for each driver, the outputs may be paralleled to achieve higher load current capability.

FEATURES

- High Peak Current Capability—600mA
- Internal Protection Diodes for Driving Inductive Loads
- Directly Compatible with TTL, CMOS, PMOS, and DTL Logic Families
- Exact Replacement for Sprague Types ULN-2001A, ULN-2002A, ULN-2003A, and ULN2004A

APPLICATIONS

- Relay Drivers
- Solenoid Drivers
- High Current Inverters

ABSOLUTE MAXIMUM RATINGS $T_A = 25^\circ\text{C}$

Output Voltage, V_{CE}	50V
Input Voltage, V_{IN}	30V
Emitter-Base Voltage, V_{EBO}	6V
Continuous Collector Current, I_C (Each Driver)	500mA
Continuous Base Current, I_B (Each Driver)	25mA
Power Dissipation, P_D (Each Driver)	1.0W
(Total Package)	2.0W
Derate Above 25°C	16.67 mW/ $^\circ\text{C}$
Storage Temperature Range	-55°C to $+150^\circ\text{C}$

FUNCTIONAL BLOCK DIAGRAM

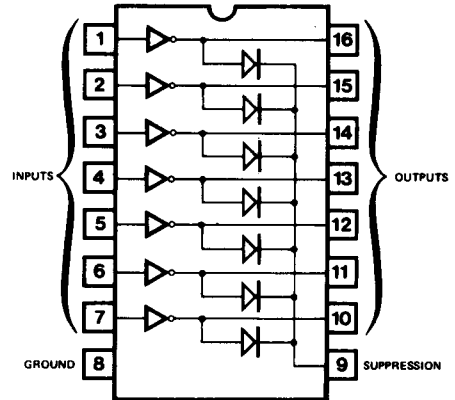

ORDERING INFORMATION

Part Number	Package	Operating Temperature
XR-2201CP	Plastic	0°C to $+85^\circ\text{C}$
XR-2202CP	Plastic	0°C to $+85^\circ\text{C}$
XR-2203CP	Plastic	0°C to $+85^\circ\text{C}$
XR-2204CP	Plastic	0°C to $+85^\circ\text{C}$

SYSTEM DESCRIPTION

The XR-2201 is compatible with most common logic forms, including PMOS, CMOS, and TTL. It requires a current-limiting resistor placed in series with the input to limit base current to less than 25mA.

The XR-2202 is designed for direct compatibility with 14V-25V PMOS devices.

The XR-2203 is compatible with TTL or CMOS operating at 5 volts. Each input has a series base resistor to limit the input current to a safe value.

The XR-2204 is designed for direct operation from CMOS or PMOS outputs utilizing supply voltages of 6 to 15V.

With all four devices, the load should be connected between the driver output and $+V_{CC}$. For protection from transient voltage spikes, Pin 9 should be connected to $+V_{CC}$.

XR-2201/2/3/4

ELECTRICAL CHARACTERISTICS

Test Conditions: $T_A = 25^\circ\text{C}$ unless otherwise noted

PARAMETERS	LIMITS			UNITS	CONDITIONS
	MIN	TYP	MAX		
Output Leakage Current XR-2202 XR-2204			100 500 500	μA μA μA	$V_{CE} = 50\text{V}, T_A = 70^\circ\text{C}$ $V_{CE} = 50\text{V}, T_A = 70^\circ\text{C}, V_{IN} = 6\text{V}$ $V_{CE} = 50\text{V}, T_A = 70^\circ\text{C}, V_{IN} = 1\text{V}$
Collector-Emitter Saturation Voltage		1.25	1.6	V	$I_C = 350\text{mA}, I_B = 500\mu\text{A}$
		1.1 0.9	1.3 1.1	V V	$I_C = 200\text{mA}, I_B = 350\mu\text{A}$ $I_C = 100\text{mA}, I_B = 250\mu\text{A}$
Input Current XR-2202 XR-2203 XR-2204		0.85 0.93 0.35 1.0	1.3 1.35 0.5 1.45	mA mA mA mA	$V_{IN} = 17\text{V}$ $V_{IN} = 3.85\text{V}$ $V_{IN} = 5\text{V}$ $V_{IN} = 12\text{V}$
Input Current	50	65		μA	$I_C = 500\mu\text{A}, T_A = 70^\circ\text{C}$
Input Voltage XR-2202 XR-2203 XR-2204			13 2.4 2.7 3.0 5.0 6.0 7.0 8.0	V V V V V V V V	$V_{CE} = 2\text{V}, I_C = 300\text{mA}$ $V_{CE} = 2\text{V}, I_C = 200\text{mA}$ $V_{CE} = 2\text{V}, I_C = 250\text{mA}$ $V_{CE} = 2\text{V}, I_C = 300\text{mA}$ $V_{CE} = 2\text{V}, I_C = 125\text{mA}$ $V_{CE} = 2\text{V}, I_C = 200\text{mA}$ $V_{CE} = 2\text{V}, I_C = 275\text{mA}$ $V_{CE} = 2\text{V}, I_C = 350\text{mA}$
D-C Forward Current Transfer Ratio XR-2201	1000				$V_{CE} = 2\text{V}, I_C = 350\text{mA}$
Input Capacitance		15	30	pF	
Turn-On Delay		1.0	5	μS	$0.5 E_{IN}$ to $0.5 E_{OUT}$
Turn-Off Delay		1.0	5	μS	$0.5 E_{IN}$ to $0.5 E_{OUT}$
Clamp Diode Leakage Current			50	μA	$V_R = 50\text{V}$
Clamp Diode Forward Voltage		1.7	2	V	$I_F = 350\text{mA}$

7

SCHEMATIC DIAGRAMS (One of 7 Identical Drivers is shown for each device.)

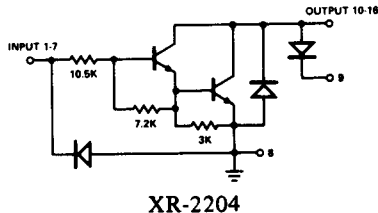
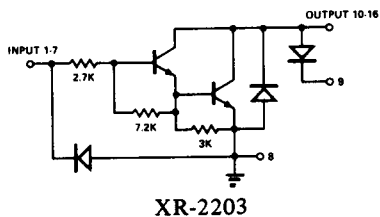
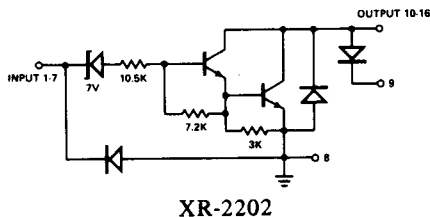
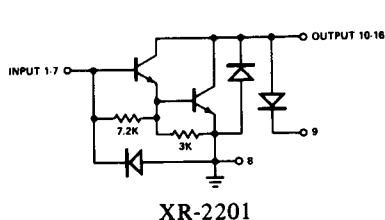

3422618 EXAR CORP



91D 04225

07-75-45-05

XR-1488/1489A

Quad Line Driver/Receiver

GENERAL DESCRIPTION

The XR-1488 is a monolithic quad line driver designed to interface data terminal equipment with data communications equipment in conformance with the specifications of EIA Standard No. RS232C. This extremely versatile integrated circuit can be used to perform a wide range of applications. Features such as output current limiting, independent positive and negative power supply driving elements, and compatibility with all DTL and TTL logic families greatly enhance the versatility of the circuit.

The XR-1489A is a monolithic quad line receiver designed to interface data terminal equipment with data communications equipment. The XR-1489A quad receiver along with its companion circuit, the XR-1488 quad driver, provide a complete interface system between DTL or TTL logic levels and the RS232C defined voltage and impedance levels.

FUNCTIONAL BLOCK DIAGRAMS

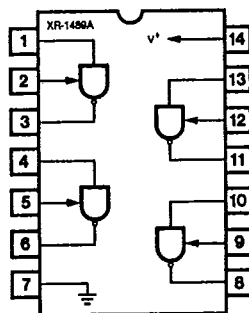
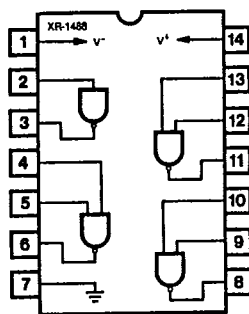

ABSOLUTE MAXIMUM RATINGS

Power Supply		
XR-1488		± 15 Vdc
XR-1489A		+ 10 Vdc
Power Dissipation		
Ceramic Package		1000 mW
Derate above +25°C		6.7 mW/°C
Plastic Package		650 mW/°C
Derate above +25°C		5 mW/°C

ORDERING INFORMATION

Part Number	Package	Operating Temperature
XR-1488N	Ceramic	0°C to +70°C
XR-1488P	Plastic	0°C to +70°C
XR-1489AN	Ceramic	0°C to +70°C
XR-1489AP	Plastic	0°C to +70°C

SYSTEM DESCRIPTION

The XR-1488 and XR-1489A are a matched set of quad line drivers and line receivers designed for interfacing between TTL/DTL and RS232C data communication lines.

The XR-1488 contains four independent split supply line drivers, each with a ±10 mA current limited output. For RS232C applications, the slew rate can be reduced to the 30 V/μS limit by shunting the output to ground with a 410 pF capacitor. The XR-1489A contains four independent line receivers, designed for interfacing RS232C to TTL/DTL. Each receiver features independently programmable switching thresholds with hysteresis, and input protection to ±30 V. The output can typically source 3 mA and sink 20 mA.

3422618 EXAR CORP
XR-494

91D 04470 D

T-58-11-31

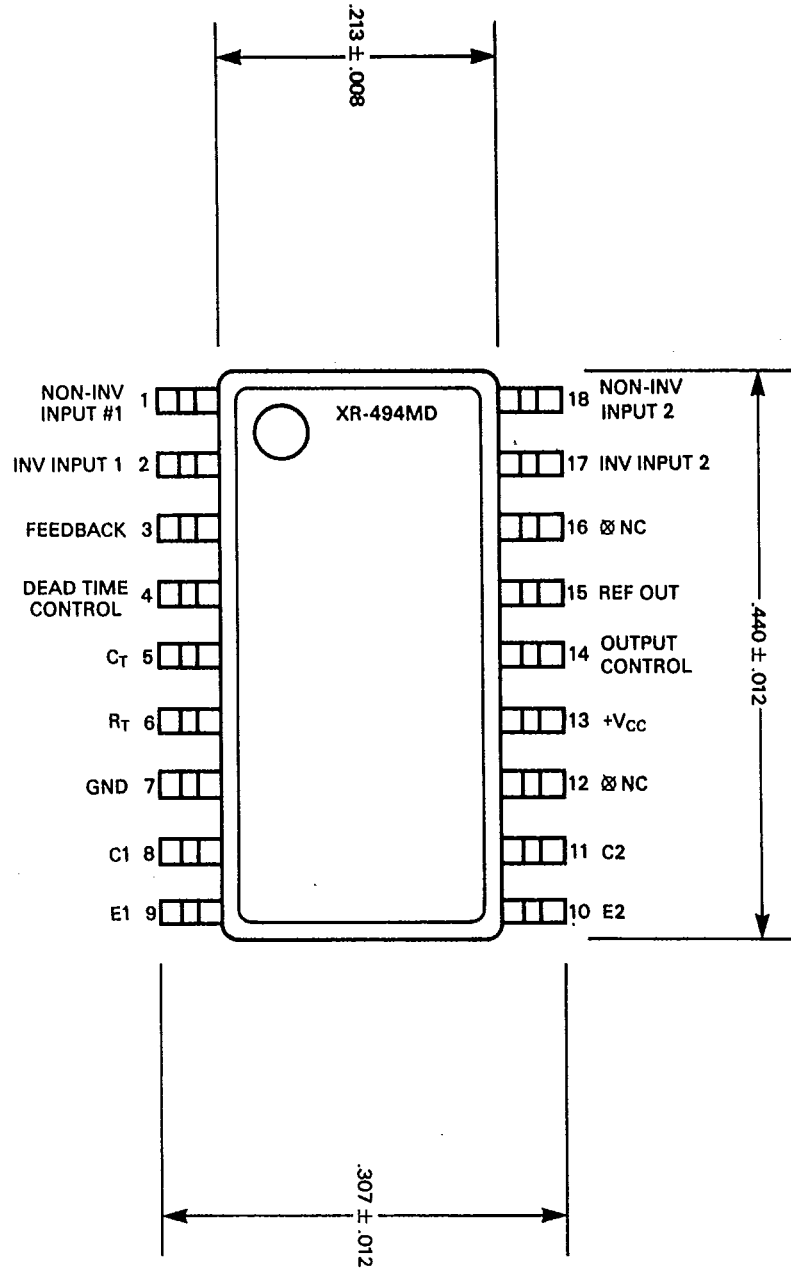

3422618 EXAR CORP

91D 04475 DT-58-11-03

XR-1468/1568

Dual-Polarity Tracking Voltage Regulator

GENERAL DESCRIPTION

The XR-1468/1568 is a dual polarity tracking voltage regulator, internally trimmed for symmetrical positive and negative 15V outputs. Current output capability is 100 mA, and may be increased by adding external pass transistors. The device is intended for local "on-card" regulation, which eliminates the distribution problems associated with single point regulation.

The XR-1468CN and XR-1568N are guaranteed over the 0°C to 70°C commercial temperature range. The XR-1568M is rated over the full military temperature range of -55°C to +125°C.

FEATURES

- Internally Set for $\pm 15V$ Outputs
- ± 100 mA Peak Output Current
- Output Voltages Balanced Within 1% (XR-1568)
- 0.06% Line and Load Regulation
- Low Stand-By Current
- Output Externally Adjustable from ± 8 to ± 20 Volts
- Externally Adjustable Current Limiting
- Remote Sensing

APPLICATIONS

- Main Regulation in Small Instruments
- On-Card Regulation in Analog and Digital Systems
- Point-of-Load Precision Regulation

ABSOLUTE MAXIMUM RATINGS

Power Supply	± 30 Volts
Minimum Short-Circuit Resistance	4.0 Ohms
Load Current, Peak	± 100 mA
Power Dissipation	
Ceramic (N) Package	1.0 Watt
Derate Above +25°C	6.7 mW/°C
Operating Temperature	
XR-1568M	-55°C to +125°C
XR-1568/XR-1468C	0°C to +70°C
Storage Temperature	-65°C to +150°C

FUNCTIONAL BLOCK DIAGRAM

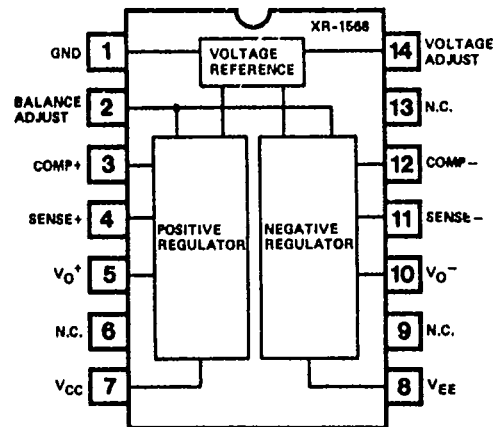

5

ORDERING INFORMATION

Part Number	Temperature	Output Offset	Package
XR-1568M	-55°C to +125°C	± 150 mV max	Ceramic
XR-1568N	0°C to +70°C	± 150 mV max	Ceramic
XR-1468CN	0°C to +70°C	± 300 mV max	Ceramic

SYSTEM DESCRIPTION

The XR-1468/1568 is a dual polarity tracking voltage regulator combining two separate regulators with a common reference element in a single monolithic circuit, thus providing a very close balance between the positive and negative output voltages. Outputs are internally set to ± 15 Volts but can be externally adjusted between ± 8.0 to ± 20 Volts with a single control. The circuit features ± 100 mA output current, with externally adjustable current limiting, and provision for remote voltage sensing.