

Type AFK, -55°C to 105°C

SMT Aluminum Electrolytic Capacitors - Lowest E.S.R., 105°C

Lowest ESR and Long Life for Filtering, Bypassing, Power Supply Decoupling



Type AFK Capacitors are the best and by a wide margin. With 40% to 60% lower impedance, 30% to 50% smaller case size and more than twice the life compared to low-ESR type AFC, the Type AFK also excels at cold performance down to -55°C. In addition, this terrific, low-impedance performance approaching low-ESR tantalum capacitors is at a significant cost savings compared to tantalum. The vertical cylindrical cases facilitate automatic mounting and reflow soldering into the same footprint of like-rated tantalum capacitors except without the need for voltage derating.

Highlights

- ◆ +105°C, Up to 5000 Hour Load Life
- ◆ Capacitance Range: 3.3 μF to 6800 μF
- ◆ Voltage Range: 6.3 Vdc to 100 Vdc

Specifications

Operating Temperature: -55°C to +105°C
 Rated Voltage: 6.3, 10, 16, 25, 35, 50, 63, 80 & 100 Vdc
 Capacitance: 3.3 μF to 6800 μF
 Capacitance Tolerance: ±20% @ 120 Hz and +20°C
 Leakage Current: 0.01 CV or 3 μA @ +20°C, after two minutes (whichever is greater)
 Ripple Current Multiplier: **Frequency**

	50/60 Hz	120 Hz	1 kHz	10 kHz	100 kHz
Dissipation Factor:	0.7	0.75	0.9	0.95	1.0

6.3 V	10 V	16 V	25 V	35 V	50 V	63 V	80 V	100 V
0.26	0.19	0.16	0.14	0.12	0.1	0.08	0.08	0.07

Add 0.02 per 1000 μF for values greater than 1000 μF

Life Test: 2000 h @ +105°C, 4.0 - 10.0 mm dia.
 5000 h @ +105°C, 12.5 - 18.0 mm dia.
 Δ Capacitance ±30%
 DF: ≤200% of limit
 DCL: ≤ 100% of limit

Shelf Life: 1000 h @ +105°C
 Δ Capacitance ±30%
 DF: ≤ 200% of limit
 DCL: ≤ 100% of limit

AFK Series Marking

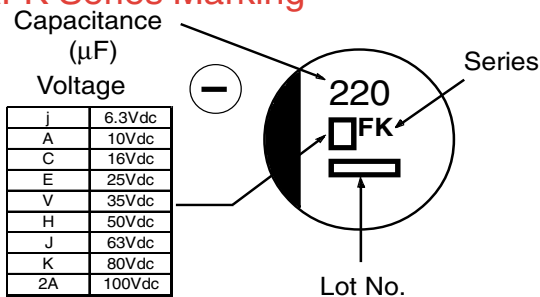

Outline Drawing

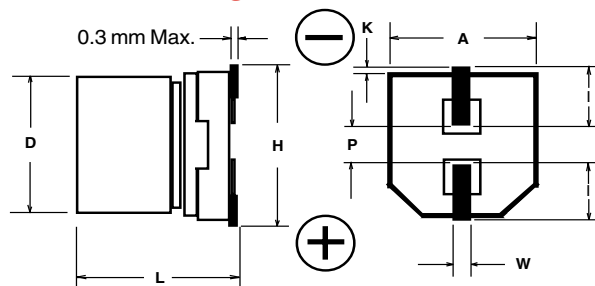

Case Dimensions

Case Code	D ±.05	L	A ±0.2	H (max)	I (ref)	W	P (ref)	K
B	4.0	5.8 ± 0.3	4.3	5.5	1.8	0.65 ± 0.1	1.0	0.35 + 0.15/-0.20
C	5.0	5.8 ± 0.3	5.3	6.5	2.2	0.65 ± 0.1	1.5	0.35 + 0.15/-0.20
D	6.3	5.8 ± 0.3	6.6	7.8	2.4	0.65 ± 0.1	1.8	0.35 + 0.15/-0.20
X	6.3	7.9 ± 0.3	6.6	7.8	2.4	0.65 ± 0.1	1.8	0.35 + 0.15/-0.20
E	8.0	6.2 ± 0.3	8.3	9.5	3.4	0.65 ± 0.1	2.2	0.35 + 0.15/-0.20
F	8.0	10.2 ± 0.3	8.3	10.0	3.4	0.90 ± 0.3	3.1	0.70 ± 0.20
G	10.0	10.2 ± 0.3	10.3	13.0	3.5	0.90 ± 0.3	4.6	0.70 ± 0.20
H	12.5	13.5 ± 0.5	13.5	15	4.7	0.90 ± 0.3	4.4	0.70 ± 0.30
P	16	16.5 ± 0.5	17	19	5.5	1.2 ± 0.3	6.7	0.70 ± 0.30
R	18	16.5 ± 0.5	19	21	6.7	1.2 ± 0.3	6.7	0.70 ± 0.30

Type AFK, -55°C to 105°C

SMT Aluminum Electrolytic Capacitors - Lowest E.S.R., 105°C

Ratings Table

Cap μF	Catalog Number	Max. DCL A/2 min)	Max. Dissipation Factor @ 120 Hz 20 °C	Max. ESR @ 100 kHz 20 °C (Ω)	Impedance @ 100 kHz 20 °C (Ω)	Max. Ripple Current @ 105°C 100 kHz (mA)	Case Code	Size (mm) D x L	Quantity per Reel
6.3 Vdc (8 Vdc Surge)									
22	AFK226M06B12T	3.0	0.26	1.35	1.35	90	B	4x5.8	2000
47	AFK476M06B12T	3.0	0.26	1.35	1.35	90	B	4x5.8	2000
47	AFK476M06C12T	3.0	0.26	0.7	0.7	160	C	5x5.8	1000
100	AFK107M06C12T	6.3	0.26	0.7	0.7	160	C	5x5.8	1000
100	AFK107M06D16T	6.3	0.26	0.36	0.36	240	D	6.3x5.8	1000
220	AFK227M06D16T	13.9	0.26	0.36	0.36	240	D	6.3x5.8	1000
330	AFK337M06X16T	20.8	0.26	0.34	0.34	280	X	6.3x7.7	900
330	AFK337M06E16T	20.8	0.26	0.26	0.26	300	E	8x6.2	1000
470	AFK477M06F24T	29.6	0.26	0.16	0.16	600	F	8x10.2	500
1000	AFK108M06F24T	63.0	0.26	0.16	0.16	600	F	8x10.2	500
1500	AFK158M06G24T	94.5	0.26	0.08	0.08	850	G	10x10.2	500
3300	AFK338M06H32T	207.9	0.3	0.06	0.06	1100	H	12.5x13.5	200
6800	AFK688M06P44T	428.4	0.36	0.035	0.035	1800	P	16x16.5	125
10 Vdc (13 Vdc Surge)									
22	AFK226M10B12T	3.0	0.19	1.35	1.35	90	B	4x5.8	2000
33	AFK336M10B12T	3.3	0.19	1.35	1.35	90	B	4x5.8	2000
33	AFK336M10C12T	3.3	0.19	0.7	0.7	160	C	5x5.8	1000
150	AFK157M10D16T	15.0	0.19	0.36	0.36	240	D	6.3x5.8	1000
220	AFK227M10X16T	22.0	0.19	0.34	0.34	280	X	6.3x7.7	900
220	AFK227M10E16T	22.0	0.19	0.26	0.26	300	E	8x6.2	1000
330	AFK337M10F24T	33.0	0.19	0.16	0.16	600	F	8x10.2	500
470	AFK477M10F24T	47.0	0.19	0.16	0.16	600	F	8x10.2	500
1000	AFK108M10G24T	100.0	0.19	0.08	0.08	850	G	10x10.2	500
2200	AFK228M10H32T	220.0	0.21	0.06	0.06	1100	H	12.5x13.5	200
4700	AFK478M10P44T	470.0	0.25	0.035	0.035	1800	P	16x16.5	125
6800	AFK688M10R44T	680.0	0.29	0.033	0.033	2060	R	18x16.5	125
16 Vdc (20Vdc Surge)									
10	AFK106M16B12T	3.0	0.16	1.35	1.35	90	B	4x5.8	2000
22	AFK226M16B12T	3.5	0.16	1.35	1.35	90	B	4x5.8	2000
22	AFK226M16C12T	3.5	0.16	0.7	0.7	160	C	5x5.8	1000
47	AFK476M16C12T	7.5	0.16	0.7	0.7	160	C	5x5.8	1000
47	AFK476M16D16T	7.5	0.16	0.36	0.36	240	D	6.3x5.8	1000
68	AFK686M16D16T	10.9	0.19	0.36	0.36	240	D	6.3x5.8	1000
100	AFK107M16D16T	16.0	0.16	0.36	0.36	240	D	6.3x5.8	1000
150	AFK157M16X16T	24.0	0.16	0.34	0.34	280	X	6.3x7.7	900
220	AFK227M16X16T	35.2	0.16	0.34	0.34	280	X	6.3x7.7	900
220	AFK227M16E16T	35.2	0.16	0.26	0.26	300	E	8x6.2	1000
330	AFK337M16F24T	52.8	0.16	0.16	0.16	600	F	8x10.2	500
470	AFK477M16F24T	75.2	0.16	0.08	0.08	850	F	8x10.2	500
680	AFK687M16G24T	108.8	0.16	0.08	0.08	850	G	10x10.2	500
1500	AFK158M16H32T	240	0.16	0.06	0.06	1100	H	12.5x13.5	200
3300	AFK338M16P44T	528	0.2	0.035	0.035	1800	P	16x16.5	125
4700	AFK478M16R44T	752	0.22	0.033	0.033	2060	R	18x16.5	125
25 Vdc (31 Vdc Surge)									
10	AFK106M25B12T	3.0	0.14	1.35	1.35	90	B	4x5.8	2000
22	AFK226M25C12T	5.5	0.14	0.7	0.7	160	C	5x5.8	1000
33	AFK336M25C12T	8.3	0.14	0.7	0.7	160	C	5x5.8	1000
33	AFK336M25D16T	8.3	0.14	0.36	0.36	240	D	6.3x5.8	1000
47	AFK476M25D16T	11.8	0.14	0.36	0.36	240	D	6.3x5.8	1000
68	AFK686M25D16T	17.0	0.14	0.36	0.36	240	D	6.3x5.8	1000
100	AFK107M25X16T	25.0	0.14	0.34	0.34	280	X	6.3x7.7	900
100	AFK107M25E16T	25.0	0.14	0.26	0.26	300	E	8x6.2	1000
150	AFK157M25F24T	37.5	0.14	0.16	0.16	600	F	8x10.2	500
220	AFK227M25F24T	55.0	0.14	0.16	0.16	600	F	8x10.2	500
330	AFK337M25F24T	82.5	0.14	0.16	0.16	600	F	8x10.2	500
470	AFK477M25G24T	117.5	0.14	0.16	0.16	850	G	10x10.2	500
1000	AFK108M25H32T	250	0.14	0.06	0.06	1100	H	12.5x13.5	200
2200	AFK228M25P44T	550	0.16	0.035	0.035	1800	P	16x16.5	125
3300	AFK338M25R44T	825	0.18	0.033	0.033	2060	R	18x16.5	125



**CORNELL
DUBILIER**

1605 East Rodney French Blvd.
New Bedford, MA 02744
(508) 996-8564, Fax (508) 996-3830
<http://www.cornell-dubilier.com>
E-mail: cdendb@cornell-dubilier.com

Your Source For Capacitor Solutions

Type AFK, -55°C to 105°C

SMT Aluminum Electrolytic Capacitors - Lowest E.S.R., 105°C

Ratings Table

Cap μF	Catalog Number	Max. DCL (μA/2 min)	Max. Dissipation		Max. ESR @		Impedance @ 100 kHz 20 °C (Ω)	Ripple Current @ 105°C 100 kHz (mA)	Case Code	Size (mm) D x L	Quantity per Reel
			@ 120 Hz 20 °C	@ 20 °C (Ω)	100 kHz 20 °C (Ω)	100 kHz 20 °C (Ω)					
35 Vdc (44 Vdc Surge)											
4.7	AFK475M35B12T	3.0	0.12	1.35	1.35	90	B	4x5.8	2000		
10	AFK106M35B12T	3.5	0.12	1.35	1.35	90	B	4x5.8	2000		
10	AFK106M35C12T	3.5	0.12	0.7	0.7	160	C	5x5.8	1000		
22	AFK226M35C12T	7.7	0.12	0.7	0.7	160	C	5x5.8	1000		
33	AFK336M35D16T	11.6	0.12	0.36	0.36	240	D	6.3x5.8	1000		
47	AFK476M35D16T	16.5	0.12	0.36	0.36	240	D	6.3x5.8	1000		
68	AFK686M35X16T	23.8	0.12	0.34	0.34	280	X	6.3x7.7	900		
100	AFK107M35X16T	35.0	0.12	0.34	0.34	280	X	6.3x7.7	900		
100	AFK107M35F24T	35.0	0.12	0.16	0.16	600	F	8x10.2	500		
150	AFK157M35F24T	52.5	0.12	0.16	0.16	600	F	8x10.2	500		
220	AFK227M35F24T	77.0	0.12	0.16	0.16	600	F	8x10.2	500		
330	AFK337M35G24T	115.5	0.12	0.08	0.08	850	G	10x10.2	500		
470	AFK477M35H32T	164.5	0.12	0.06	0.06	1100	H	12.5x13.5	200		
680	AFK687M35H32T	238	0.12	0.06	0.06	1100	H	12.5x13.5	200		
1500	AFK158M35P44T	525	0.12	0.035	0.035	1800	P	16x16.5	125		
50 Vdc (63 Vdc Surge)											
4.7	AFK475M50B12T	2.4	0.10	2.9	2.9	60	B	4x5.8	2000		
10	AFK106M50C12T	5.0	0.10	1.52	1.52	85	C	5x5.8	1000		
10	AFK106M50D16T	5.0	0.10	0.88	0.88	165	D	6.3x5.8	1000		
22	AFK226M50D16T	11.0	0.10	0.88	0.88	165	D	6.3x5.8	1000		
33	AFK336M50X16T	16.5	0.10	0.68	0.68	195	X	6.3x7.7	900		
33	AFK336M50E16T	16.5	0.10	0.68	0.68	195	E	8x6.2	1000		
47	AFK476M50X16T	23.5	0.10	0.68	0.68	195	X	6.3x7.7	900		
47	AFK476M50E16T	23.5	0.10	0.68	0.68	195	E	8x6.2	1000		
100	AFK107M50F24T	50.0	0.10	0.34	0.34	350	F	8x10.2	500		
150	AFK157M50G24T	75.0	0.10	0.18	0.18	670	G	10x10.2	500		
220	AFK227M50G24T	110	0.10	0.18	0.18	670	G	10x10.2	500		
330	AFK337M50H32T	165	0.10	0.12	0.12	900	H	12.5x13.5	200		
680	AFK687M50P44T	340	0.10	0.073	0.073	1610	P	16x16.5	125		
1000	AFK108M50P44T	500	0.10	0.073	0.073	1610	P	16x16.5	125		
63 Vdc (75 Vdc Surge)											
4.7	AFK475M63C12T	2.96	0.08	3	3	50	C	5x5.8	1000		
10	AFK106M63D16T	6.3	0.08	1.5	1.5	80	D	6.3x5.8	1000		
22	AFK226M63X16T	13.9	0.08	1.2	1.2	120	X	6.3x7.7	900		
22	AFK226M63E16T	13.9	0.08	1.2	1.2	120	E	8x6.2	1000		
33	AFK336M63F24T	20.8	0.08	0.65	0.65	250	F	8x10.2	500		
47	AFK476M63F24T	29.6	0.08	0.65	0.65	250	F	8x10.2	500		
68	AFK686M63G24T	42.8	0.08	0.35	0.35	400	G	10x10.2	500		
100	AFK107M63G24T	63.0	0.08	0.35	0.35	400	G	10x10.2	500		
150	AFK157M63H32T	94.5	0.08	0.35	0.35	800	H	12.5x13.5	200		
220	AFK227M63H32T	138.6	0.08	0.16	0.16	800	H	12.5x13.5	200		
470	AFK477M63P44T	296.1	0.08	0.082	0.082	1410	P	16x16.5	125		
680	AFK687M63R44T	428.4	0.08	0.08	0.08	1690	R	18x16.5	125		
80 Vdc (100 Vdc Surge)											
3.3	AFK335M80C12T	2.64	0.08	5	5	25	C	5x5.8	1000		
4.7	AFK475M80D16T	3.76	0.08	3	3	40	D	6.3x5.8	1000		
10	AFK106M80X16T	8.0	0.08	2.4	2.4	60	X	6.3x7.7	900		
10	AFK106M80E16T	8.0	0.08	2.4	2.4	60	E	8x6.2	1000		
22	AFK226M80F24T	17.6	0.08	1.3	1.3	130	F	8x10.2	500		
33	AFK336M80F24T	26.4	0.08	1.3	1.3	130	F	8x10.2	500		
47	AFK476M80G24T	37.6	0.08	0.7	0.7	200	G	10x10.2	500		
68	AFK686M80H32T	54.4	0.08	0.32	0.32	500	H	12.5x13.5	200		
100	AFK107M80H32T	80.0	0.08	0.32	0.32	500	H	12.5x13.5	200		
150	AFK157M80H32T	120	0.08	0.32	0.32	500	H	12.5x13.5	200		
330	AFK337M80P44T	264	0.08	0.17	0.17	793	P	16x16.5	125		
470	AFK477M80R44T	376	0.08	0.153	0.153	917	R	18x16.5	125		
100 Vdc (125 Vdc Surge)											
22	AFK226M2AF24T	22.0	0.07	1.3	1.3	130	F	8x10.2	500		
33	AFK336M2AG24T	33.0	0.07	0.7	0.7	200	G	10x10.2	500		
47	AFK476M2AH32T	47.0	0.07	0.32	0.32	500	H	12.5x13.5	200		
68	AFK686M2AH32T	68.0	0.07	0.32	0.32	500	H	12.5x13.5	200		
100	AFK107M2AP44T	100	0.07	0.17	0.17	793	P	16x16.5	125		
150	AFK157M2AP44T	150	0.07	0.17	0.17	793	P	16x16.5	125		
220	AFK227M2AR44T	220	0.07	0.153	0.153	917	R	18x16.5	125		
330	AFK337M2AR44T	330	0.07	0.153	0.153	917	R	18x16.5	125		

Part Numbering System

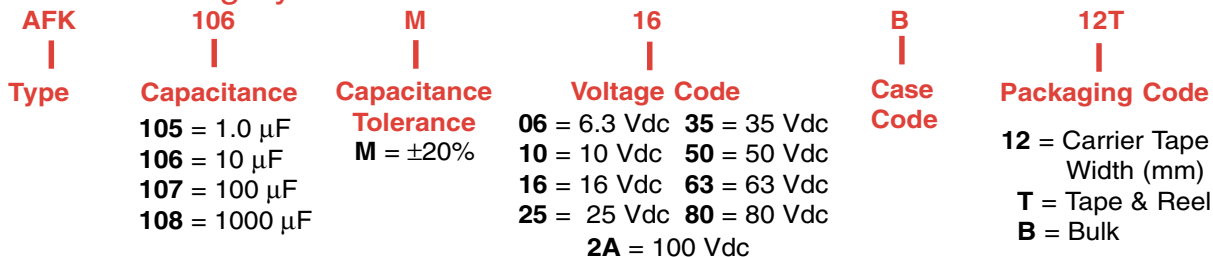

Type AFK, -55°C to 105°C

SMT Aluminum Electrolytic Capacitors - Lowest E.S.R., 105°C

Typical Performance Curves

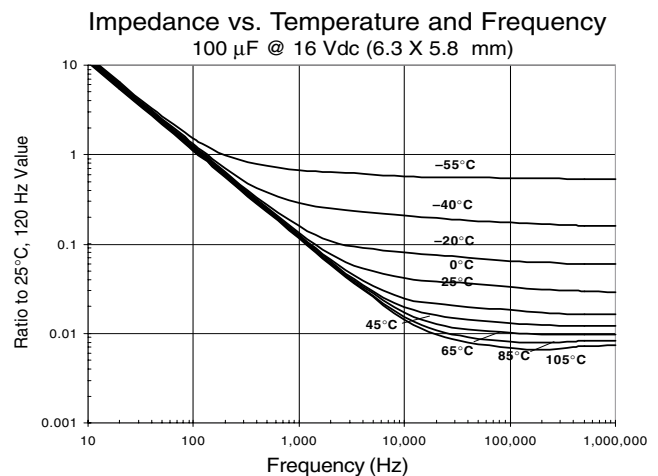
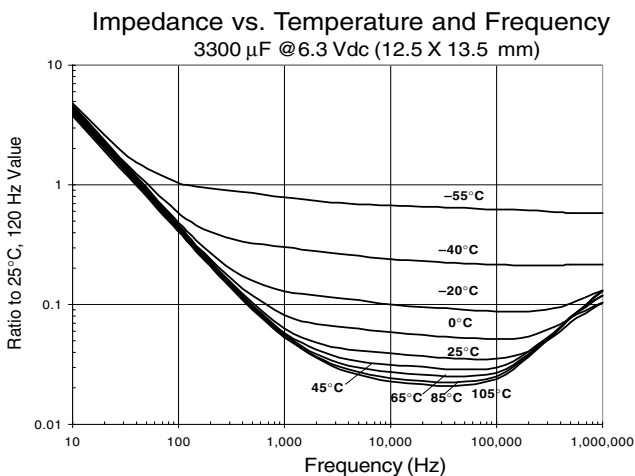
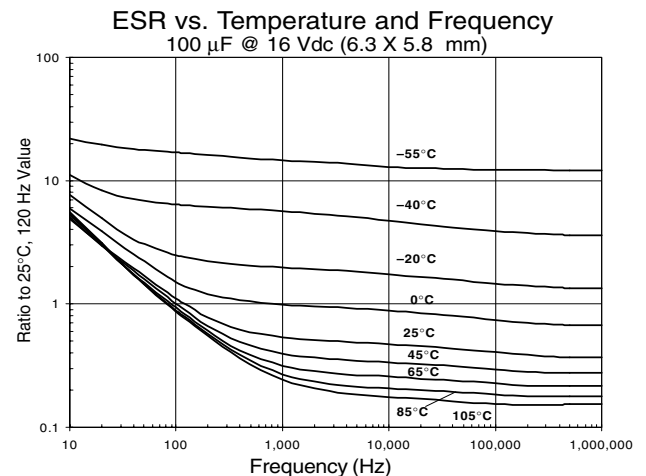
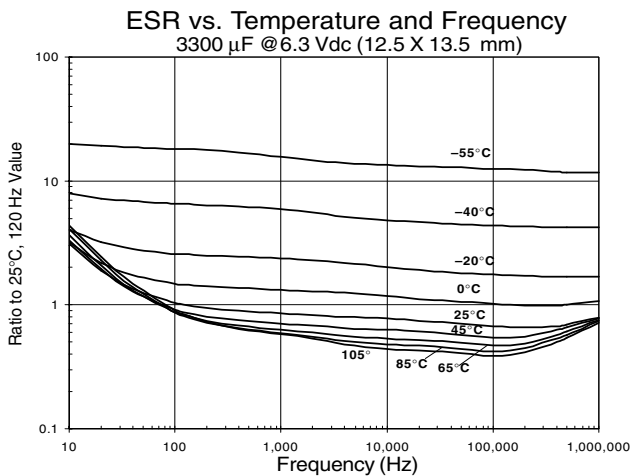
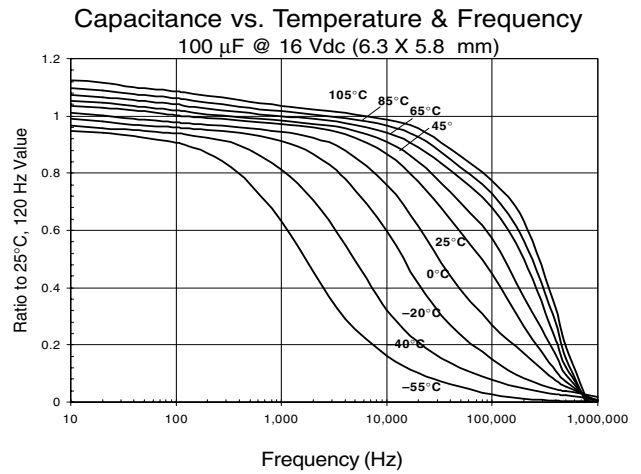
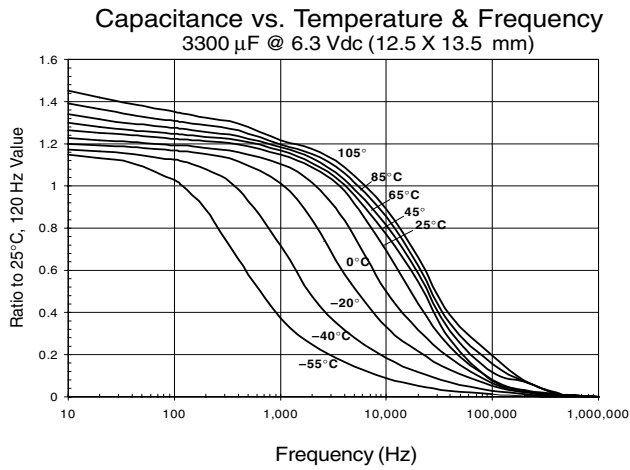

Type AFK, -55°C to 105°C

SMT Aluminum Electrolytic Capacitors - Lowest E.S.R., 105°C

Typical Performance Curves

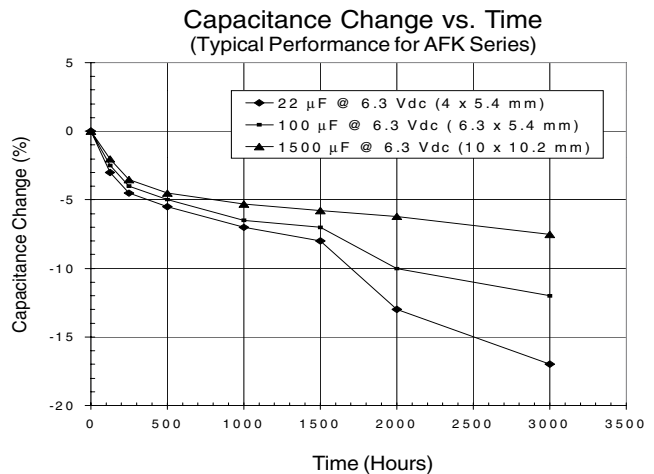
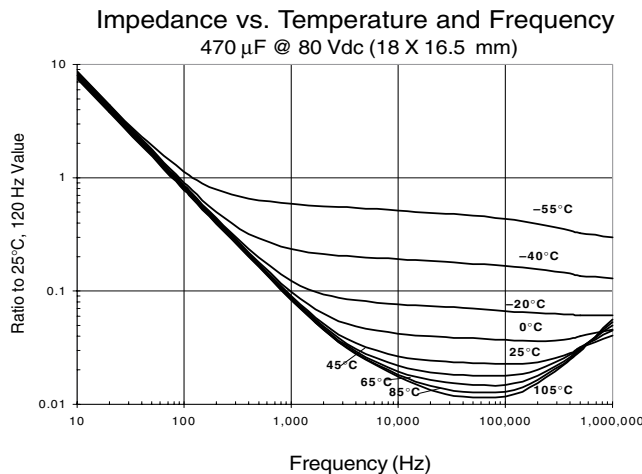
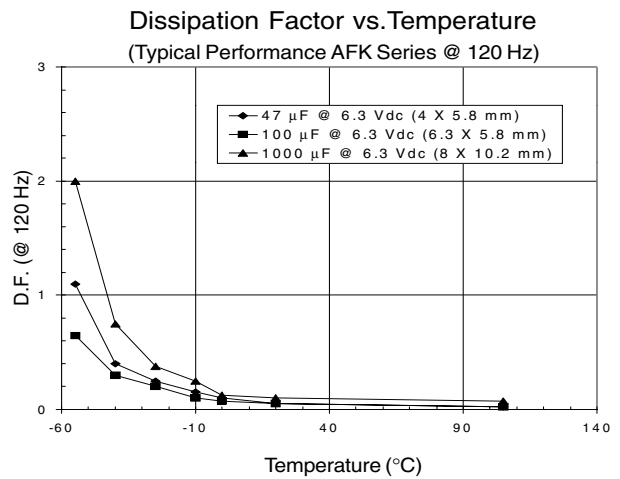
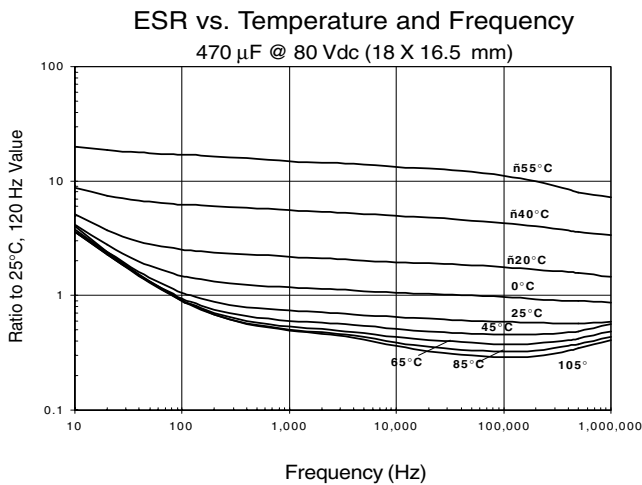
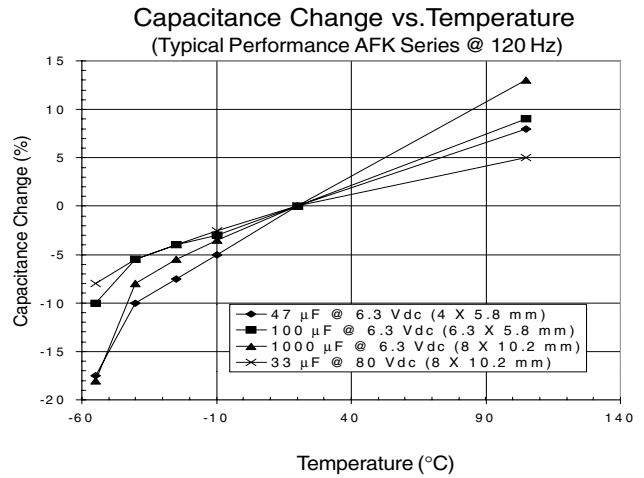
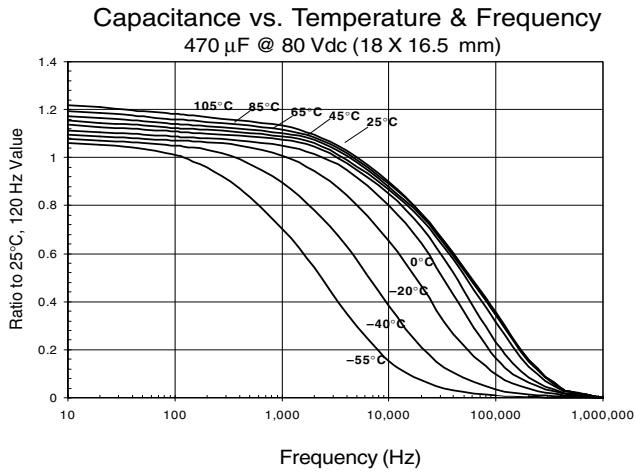

AVS, AHA, AFC, AFK, AHD, AEB Tape and Reel Specifications

Tape Specifications

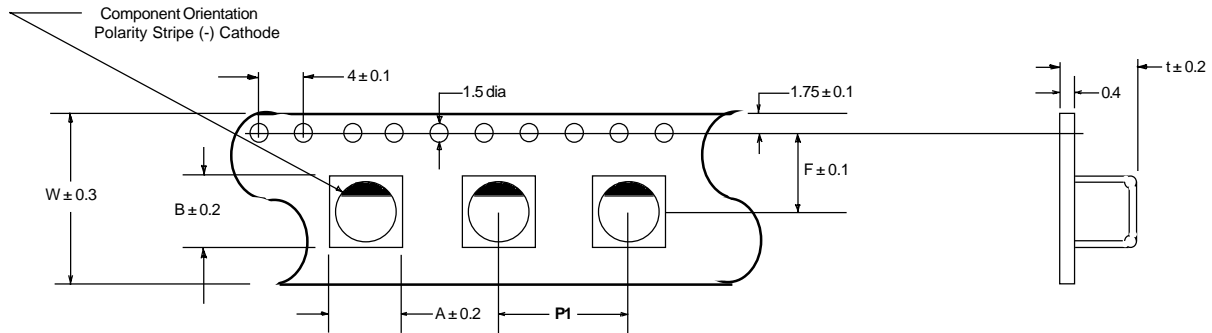

(mm)

Case Code	W	A	B	P1	F	t
A	12.0	3.4	3.5	8.0	5.5	5.8
B	12.0	4.7	4.6	8.0	5.5	5.8
C	12.0	6.0	6.0	12.0	5.5	5.8
D	16.0	7.0	7.0	12.0	7.5	5.8
X	16.0	7.0	7.0	12.0	7.5	8.4
E	16.0	8.7	8.7	12.0	7.5	6.8
F	24.0	8.7	8.7	16.0	11.5	11.0
G	24.0	10.7	10.7	16.0	11.5	11.0

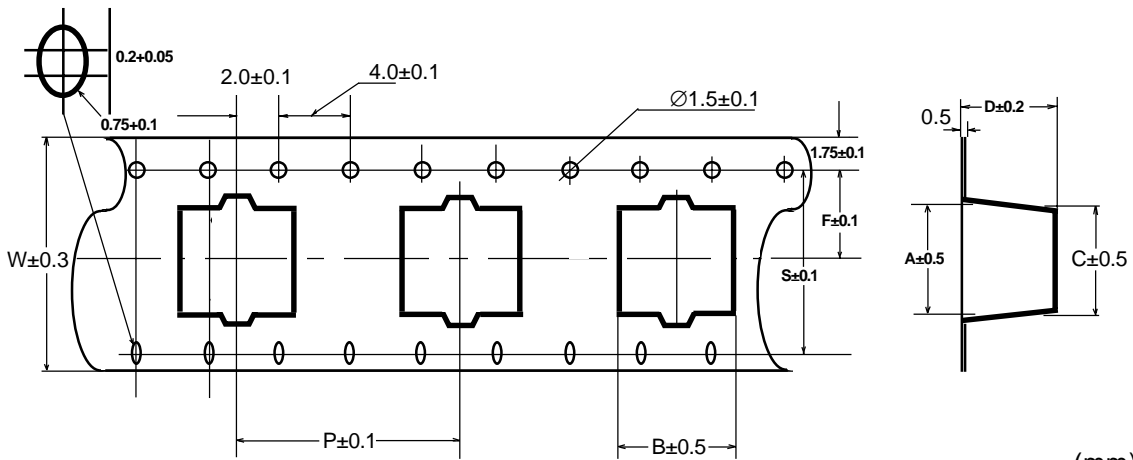

(mm)

Case Code	W	A	B	C	D	F	P	S
J	32.0	10.7	10.7	14.5	14.5	14.2	20.0	28.4
K	32.0	10.7	10.7	14.5	18.5	14.2	20.0	28.4
H	32.0	14.0	14.0	18.0	14.5	14.2	24.0	28.4
L	32.0	14.0	14.0	18.0	17.5	14.2	24.0	28.4
P	44.0	17.5	17.5	23.0	17.5	20.2	28.0	40.4
R	44.0	19.5	19.5	26.0	17.5	20.2	32.0	40.4
S	44.0	19.5	19.5	26.0	22.5	20.2	32.0	40.4
U	44	17.5	17.5	23	22.5	20.2	28	40.4

AVS, AHA, AFC, AFK, AHD, AEB Tape and Reel Specifications

Reel Specifications

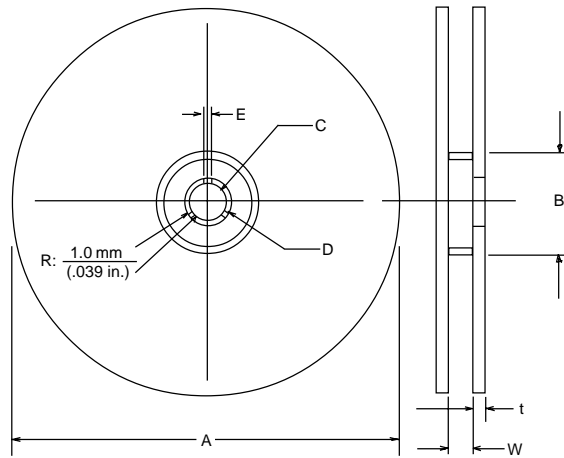

(mm)

Case Code	A	B	C	D	E	W	t
A, B size	380±2	50 min	13.0±0.5	21.0±0.8	2.0±0.5	14±1	3.0
C, D, E, X size	380±2	50 min	13.0±0.5	21.0±0.8	2.0±0.5	18±1	3.0
F, G size	380±2	50 min	13.0±0.5	21.0±0.8	2.0±0.5	26±1	3.0
J, K, H, L size	330±2	50 min	13.0±0.5	21.0±0.8	2.0±0.5	34±1	3.0
P, R, S, U size	330±2	50 min	13.0±0.5	21.0±0.8	2.0±0.5	46±1	3.0

Land Pattern:

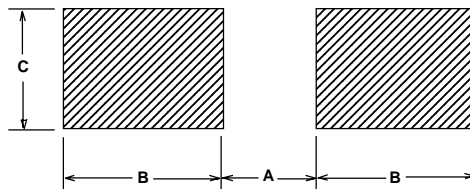

(mm)

Case Code	A	B	C
A	0.6	2.2	1.5
B	1.0	2.5	1.6
C	1.5	2.8	1.6
D	2.2	3.0	1.6
E	2.2	4.5	1.6
F	3.2	4.0	2.0
G	4.6	4.3	2.0
J, K	4	4.5	2.0
H	4.0	5.7	2.0
L	4.0	5.7	2.0
P	6.0	6.5	2.5
R, U	6.0	6.5	2.5
S	6.0	7.5	2.5

AVS, AHA, AFC, AFK, AHD, AEB Reflow Solder & Case Dimensions

Reflow Soldering Temperature Profile:

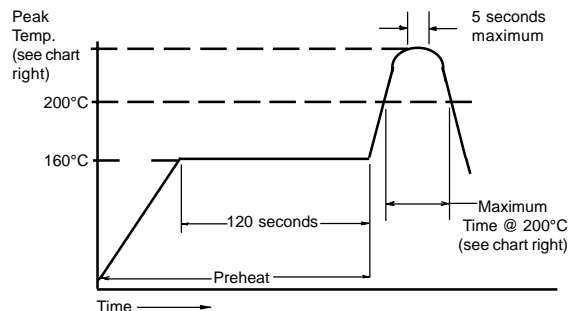

Case Code	Peak Temp (°C)	Max. Time @ 200°C (Sec.)
A, B, C, D, X	240	40
E, F, G, H J, K, L, P R, S, U	230	30

Outline Drawing

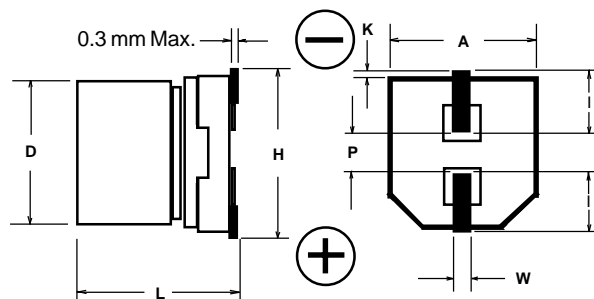

Case Dimensions

(mm)

Case Code	D ± 0.5	L	A ± 0.2	H (max)	I (ref)	W	P (ref)	K
A	3.0	5.4 +.1,-.2	3.3	4.5	1.5	0.55 ± 0.1	0.6	0.35 + 0.15/-0.20
B	4.0	5.4 +.1,-.2	4.3	5.5	1.8	0.65 ± 0.1	1.0	0.35 + 0.15/-0.20
C	5.0	5.4 +.1,-.2	5.3	6.5	2.2	0.65 ± 0.1	1.5	0.35 + 0.15/-0.20
D	6.3	5.4 +.1,-.2	6.6	7.8	2.4	0.65 ± 0.1	1.8	0.35 + 0.15/-0.20
X	6.3	7.9 ±.3	6.6	7.8	2.6	0.65 ± 0.1	1.8	0.35 + 0.15/-0.20
E	8.0	6.2 ±.3	8.3	9.5	3.4	0.65 ± 0.1	2.2	0.35 + 0.15/-0.20
F	8.0	10.2 ±.3	8.3	10	3.4	0.90 ± 0.2	3.2	0.70 ± 0.20
G	10.0	10.2 ±.3	10.3	12	3.5	0.90 ± 0.2	4.6	0.70 ± 0.20
H	12.5	13.5 ±.5	13.5	15	4.7	0.9 ± 0.3	4.4	0.70 ± 0.30
J	10	13.5	10.3	12	3.5	0.9 ± 0.2	4.6	0.70 ± 0.20
K	10	17.5	10.3	12	3.5	0.9 ± 0.2	4.6	0.70 ± 0.20
L	12.5	16.5 ±.5	13.5	15.0	4.7	0.9 ± 0.3	4.4	0.70 ± 0.30
P	16.0	16.5 ±.5	17.0	19.0	5.5	1.2 ± 0.3	6.7	0.70 ± 0.30
R	18.0	16.5 ±.5	19.0	21.0	6.5	1.2 ± 0.3	6.7	0.70 ± 0.30
S	18.0	21.5 ±.5	19.0	21.0	6.5	1.2 ± 0.3	6.7	0.70 ± 0.30
U	16.0	21.5	17.0	19.0	6.7	1.2 ± 0.3	6.7	0.70 ± 0.30

*5.8 +0.1,-0.2 for AFK and AHD Series

V-Chip Cleaning and Coating Guide

Cleaning

Below is a table describing the usable solvents for cleaning a PC board containing V-Chips.

Table 1

Solvent type	Name	Manufacturer	Recommended use level	Symtoms of Damage
Water Base				
Water	Distilled Water		1	None
Alkaline	Aqua Cleaner 210SEP	Sanei	2	None, though marking ink may fade
Surface active agent	Pine Alpha ST-100S	Aralawa Kasei Kogyo	2	
	Clean-thru 750H	Kao Corporation	2	
	Clean-thru 750L		2	
	Clean-thru 710M		2	
	Sun-elec B-12	Sanyo Kasei	2	
DK be-clean CW-5790	Dai-Ichi Kogyo Seiyaku	2		
Solvent Base				
Petroleum based	Cold-cleaner P3-375	Henkel Hokusui	3	swelling on sealing rubber rinse and dry well after cleaning
	Techno-cleaner 219	Seiwa Sangyo	3	
hydrocarbon	Axarel 32	Mitsui DFC	3	
Alcohol base	Isopropyl Alcohol		1	None
Silicon base	Techno-care FRW-17	Toshiba Corporation	3	None if used in combination
	Techno-care FRW-17		3	
	(Techno-care FRV-100)		3	
Halogenated hydrocarbon	Asashi-clean AK-225AES	Ashahi Glass	3	Contains CFC's subject to environmental regulations
	HCFC141B-MS	Dalkin Kogyo	3	
Telpen base	Telpen-cleaner EC-7R	Nippon Alpha Metals	3	swelled seal

Use level Number	Recommendation
1	Cleaning is possible
2	Cleaning is possible (markings may fade)
3	Cleaning is possible (Use caution. 1 and 2 are better choices)

V-Chips may be immersed for 5 minutes, safely, in Level 1&2 solvents. Use Level 3 solvents with caution.

Do not use chlorine-based halogenated cleaning solvents, adhesives or coating agents.

When halogenated chlorine-based solvents are used in the cleaning process, free chlorine is liberated from the solvent. This chlorine causes corrosion and deterioration of the aluminum inside the capacitor

Dangers of "Free-Chlorine":

After the solvent dries, the chlorine remains on the capacitor seal, the chlorine slowly permeates into the capacitor element causing corrosion and damage that happens slowly. It may take some time before a failure is apparent. A representation of the chemical reaction is on the following page.

V-Chip Cleaning and Coating Guide

Free-chlorine Diagram:

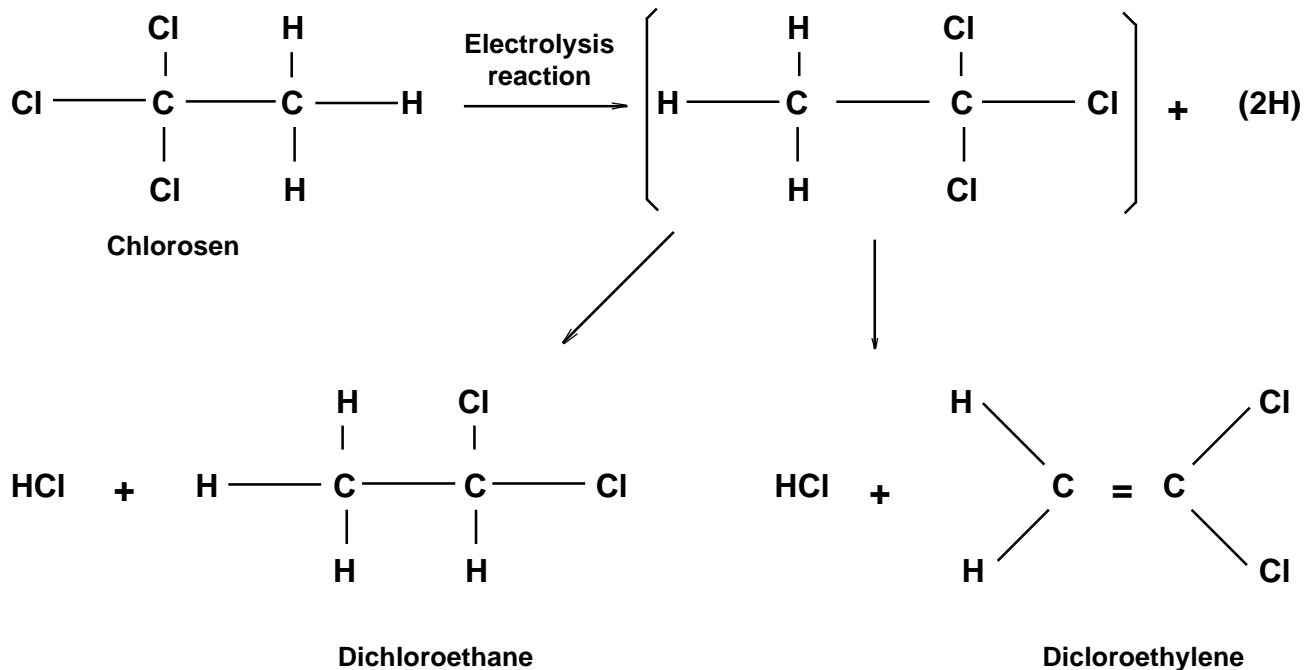
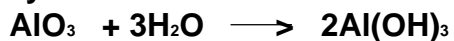

Fig. 1 Decomposed reaction of cleaning solvents (Free-chlorine)

Reaction of Free-chlorine and Aluminum

Combined free chlorine and hydrogen become hydrochloric acid, but it has high dissociation and most of it becomes chlorine ions. These chlorine ions react with the aluminum. The order of the reactions is represented below.

1.) Hydration of oxide film



2.) Reaction of hydrated oxide film and chlorine (Dissolution of film)

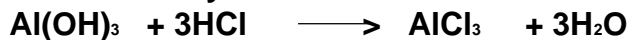

3.) Reaction of aluminum and hydrochloric acid (Dissolution of aluminum)

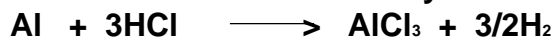

4.) Precipitation of aluminum hydroxide



The entire reaction can be summarized as the following:

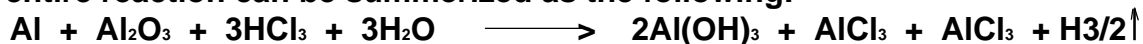

Therefore the compounds produced by the reactions are aluminum hydroxide and hydrochloric acid from reaction #4; the hydrochloric acid is not consumed and acts as a catalyst.

V-Chip Cleaning and Coating Guide

Solvents that should not be used

Table 2

Composition	Boiling Point (°C)	Common Name
1.1.1-Trichloroethane	74.1	Chlorosen
Trichloroethylene	87.2	Trichlene
Tetrachloroethylene	121.1	Perchloroethylene

Additional Cleaning Notes:

- 1.) Solvents containing CFC's destroy the ozone layer and should be avoided to protect the global environment.
- 2.) To avoid solvent residue between the capacitor's seal and the PC board, make sure the assembly is dried thoroughly immediately after cleaning.

Coating

Below is a list of coatings that are safe for use with V-Chips

Table 3

Manufacturer	Material	Coating Material Name
Hitachi Chemical	Acrylic	Taffi-1141, Taffi-1147
	Urethane	Taffi-1154
Boxy Brown	Acrylic	Humi Seal 1B66
	Urethane	Humi Seal 1A27
Dow Corning	Silicon	Perugan Z, Perugan C
Nihon Zeon	Urethane	Quinate System 160B

Influence of Coating Materials

Coating materials are typically used for insulation, waterproofing, dustproofing and rustproofing. When coating materials are selected there are factors to prevent internal corrosion (chlorine reaction with aluminum) while the capacitor is functioning. The following steps will help prevent this damage to the capacitor.

A.) Corrosion Reaction

Avoid halogen solvents which permeate the capacitor's seal, releasing chlorine which reacts with the aluminum inside the capacitor.

B.) Selecting a Coating Material

It is necessary to select a coating material that contains no chlorine.

The coating consists of the main ingredient which could be urethane resin, acrylic resin or other polymer, a solvent and other additives such as flameproofing agents.

V-Chip Cleaning and Coating Guide

The coating's solvent dries and diffuses into the rubber seal of the capacitor, therefore halogenated hydrocarbon solvents containing chloride should not be used.

Similar to the solvent, additives can permeate into the capacitor through the rubber seal. Ingredients in many additives might not be listed, therefore use caution when choosing an additive.

C.) Other Concerns

Solvents and additives are subject to change without notice. Make sure ingredients are identified.

Avoid coating a substrate after cleaning it with a halogenated hydrocarbon. The coating will prevent the remaining solvent from diffusing which may cause corrosion.