

## Power Schottky Rectifier - 40Amp 100Volt

**Features**

- Plastic package has Underwriters Laboratory Flammability Classifications 94V-0
- High Junction Temperature Capability
- Low forward voltage, high current capability
- High surge capacity
- Low power loss, high efficiency
- ESD performance human body mode > 8 KV

**Application**

- AC/DC Switching Adaptor and TFT-LCD Power Supply
- SMPS

**Absolute maximum ratings**

Symbol	Ratings	Unit	Conditions
$I_F(AV)$	40	A	Average Forward Current
$V_{RRM}$	100	V	Repetitive Peak Reverse Voltage
$I_{FSM}$	400	A	Peak Forward Surge Current
$V_F(max)$	0.66	V	Forward Voltage Drop
$T_j$	-50 to +175	°C	Operating Temperature
$T_{stg}$	-50 to +150	°C	Storage Temperature

**Electrical characteristics**

Parameters	Symbol	Ratings	Conditions
Maximum Instantaneous Forward Voltage	$V_F$	0.82V	$T_c = 25^\circ C$
		0.66V	$T_c = 125^\circ C$
Maximum Reverse Leakage Current	$I_R$	0.01mA	$T_c = 25^\circ C$
		10mA	$T_c = 125^\circ C$
Maximum Voltage Rate of Change	$dv/dt$	10,000 V/ $\mu$ s	Rated $V_R$
Typical Thermal Resistance, Junction to Case	$R_{\theta(j-c)}$	2.2 °C/W	Per diode

Note: Pulse Test : 380 $\mu$ s pulse width, 2% duty cycle

**T0-220AB**

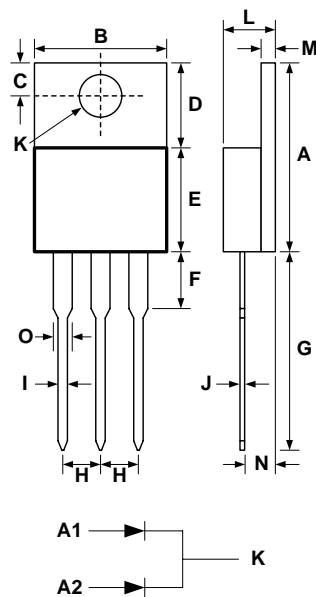

DIM	DIMENSIONS				NOTE
	INCHES		MM		
	MIN	MAX	MIN	MAX	
A	.579	.606	14.70	15.40	
B	.392	.411	9.95	10.45	
C	.104	.116	2.65	2.95	
D	.248	.272	6.30	6.90	
E	.325	.350	8.25	8.90	
F	.126	.157	3.20	4.00	
G	.492	.551	12.50	14.00	
H	.096	.108	2.45	2.75	
I	.028	.039	0.70	1.00	
J	.010	.022	0.25	0.55	
K	.146	.157	3.70	4.00	
L	.167	.187	4.25	4.75	
M	.045	.057	1.15	1.45	
N	.089	.114	2.25	2.90	
O	.047	.055	1.20	1.40	

August 2008 / Rev.6.1

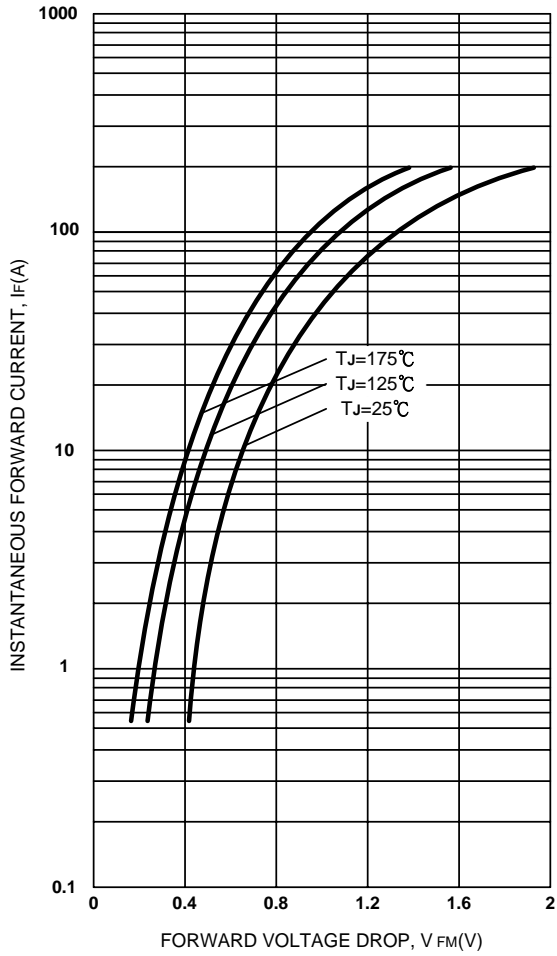

**Figure 1. Max. Forward Voltage Drop Characteristics (PerLeg)**

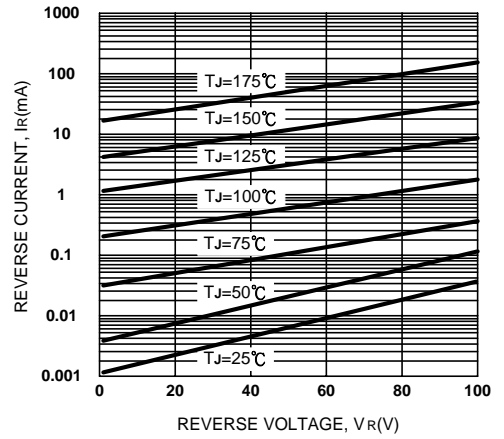

**Figure 2. Typical Values Of Reverse Current Vs. Reverse Voltage (PerLeg)**

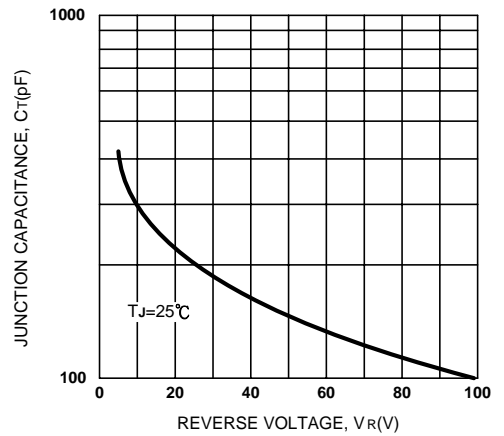

**Figure 3. Typical Junction Capacitance Vs. Reverse Voltage (PerLeg)**

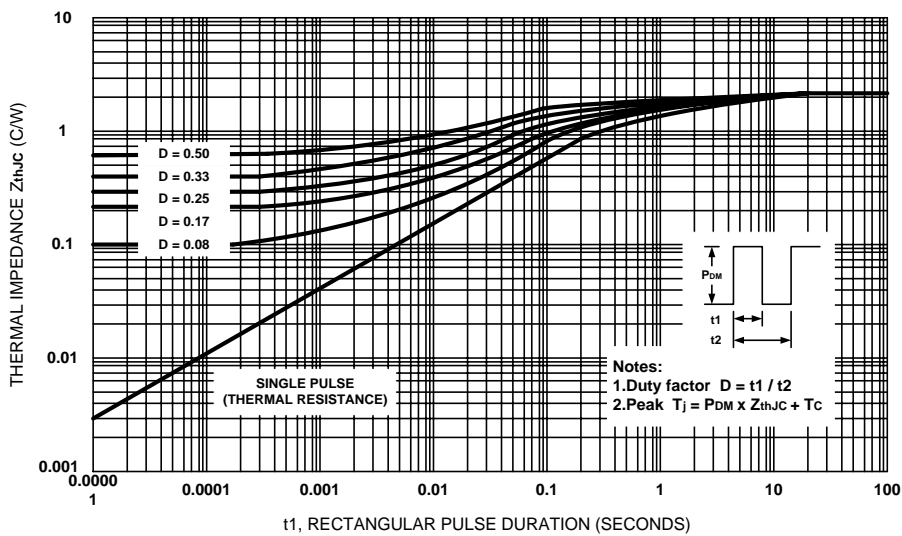

**Figure 4. Max. Thermal Impedance  $Z_{thJC}$  Characteristics (PerLeg)**

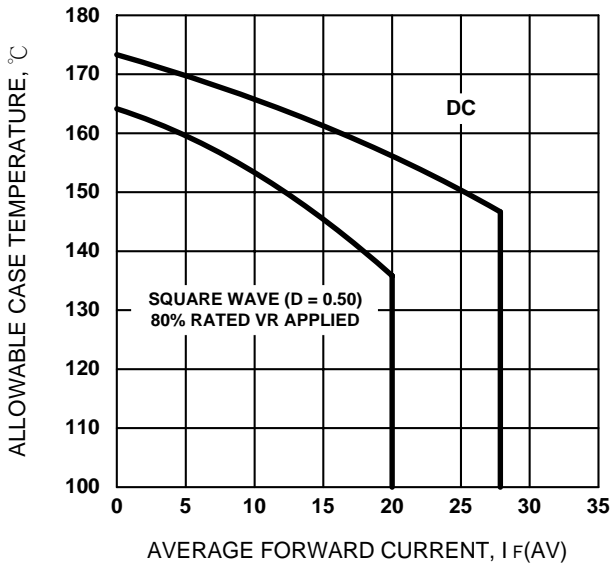

**Figure 5. Max. Allowable Case Temperature Vs. Average Forward Current (Per Leg)**

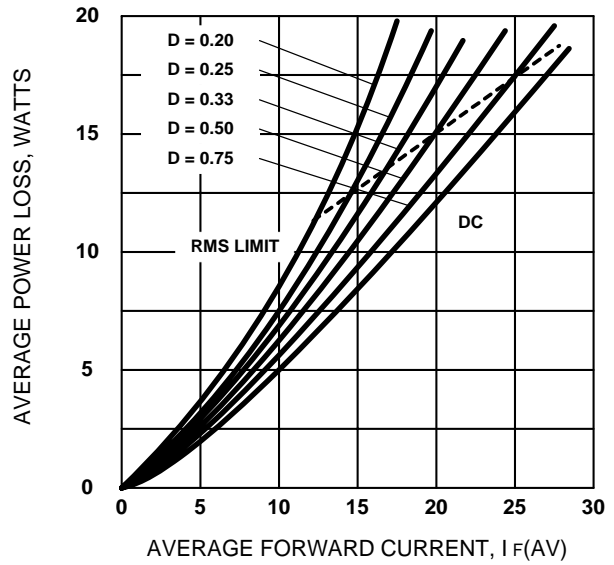

**Figure 6. Forward Power Loss Characteristics (Per Leg)**

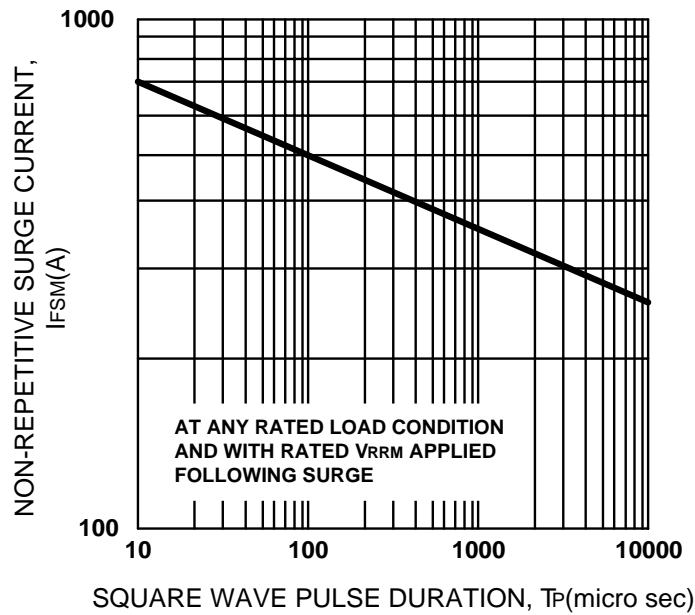

**Figure 7. Max. Non-Repetitive Surge Current (Per Leg)**