

## TRIACs, 25A

### Sunbberless and Standard

#### FEATURES

- High current triac
- Low thermal resistance with clip bonding
- Low thermal resistance insulation ceramic for insulated TO-220AB & TO-3P package
- High commutation (4 quadrant) or very High commutation (3 quadrant) capability
- 25T series are **UL** certified (File ref: E320098)
- Packages are RoHS compliant

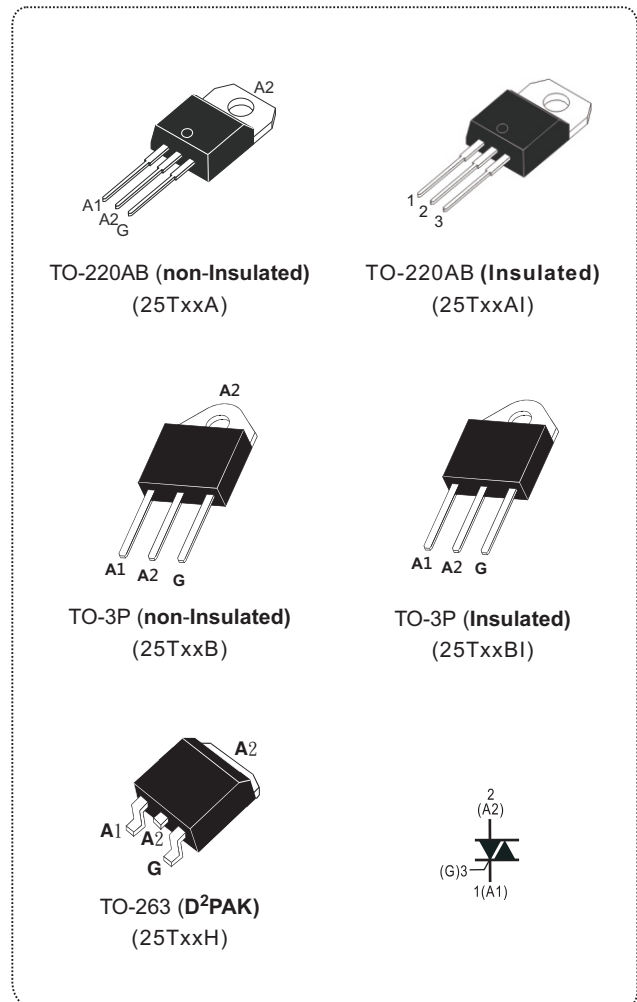
#### APPLICATIONS

Applications include the ON/OFF function in applications such as static relays, heating regulation, induction motor starting circuits, etc., or for phase control operation in light dimmers, motor speed controllers, and silmilar.

The snubberless versions are especially recommended for use on inductive loads, due to their high commutation performances. The 25T series provides an insulated tab (rated at 2500V<sub>RMS</sub>).

#### MAIN FEATURES

SYMBOL	VALUE	UNIT
$I_{T(RMS)}$	25	A
$V_{DRM}/V_{RRM}$	600 to 1200	V
$I_{GT(Q1)}$	35 to 50	mA



ABSOLUTE MAXIMUM RATINGS					
PARAMETER	SYMBOL	TEST CONDITIONS		VALUE	UNIT
RMS on-state current (full sine wave)	$I_{T(RMS)}$	TO-3P	$T_c = 105^\circ\text{C}$	25	A
		TO-263/TO-220AB/TO-3P insulated	$T_c = 100^\circ\text{C}$		
		TO-220AB insulated	$T_c = 75^\circ\text{C}$		
Non repetitive surge peak on-state current (full cycle, $T_j$ initial = 25°C)	$I_{TSM}$	F = 50 Hz	t = 20 ms	250	A
		F = 60 Hz	t = 16.7 ms	260	
$I^2t$ Value for fusing	$I^2t$	$t_p = 10$ ms		340	A <sup>2</sup> s
Critical rate of rise of on-state current $I_G = 2xI_{GT}$ , $t_r \leq 100$ ns	dI/dt	F = 100 Hz	$T_j = 125^\circ\text{C}$	50	A/ $\mu$ s
Peak gate current	$I_{GM}$	$T_p = 20$ $\mu$ s	$T_j = 125^\circ\text{C}$	4	A
Average gate power dissipation	$P_{G(AV)}$	$T_j = 125^\circ\text{C}$		1	W
Storage temperature range	$T_{stg}$			- 40 to + 150	°C
Operating junction temperature range	$T_j$			- 40 to + 125	

⊙ ELECTRICAL CHARACTERISTICS (T<sub>J</sub>= 25 °C unless otherwise specified)

SNUBBERLESS and Logic level (3 quadrants)						
SYMBOL	TEST CONDITIONS	QUADRANT		25Txxxx		Unit
				CW	BW	
I <sub>GT</sub> <sup>(1)</sup>	V <sub>D</sub> = 12 V, R <sub>L</sub> = 30Ω	I - II - III	MAX.	35	50	mA
V <sub>GT</sub>		I - II - III		1.3		V
V <sub>GD</sub>	V <sub>D</sub> = V <sub>DRM</sub> , R <sub>L</sub> = 3.3KΩ T <sub>j</sub> = 125°C	I - II - III	MIN.	0.2		V
I <sub>H</sub> <sup>(2)</sup>	I <sub>T</sub> = 500 mA		MAX.	50	75	mA
I <sub>L</sub>	I <sub>G</sub> = 1.2 I <sub>GT</sub>	I - III	MAX.	70	80	mA
		II		80	100	
dV/dt <sup>(2)</sup>	V <sub>D</sub> = 67% V <sub>DRM</sub> , gate open, T <sub>j</sub> = 125°C		MIN.	500	1000	V/μs
(dI/dt) <sub>c</sub> <sup>(2)</sup>	Without snubber, T <sub>j</sub> = 125°C			13	22	A/ms

⊙ ELECTRICAL CHARACTERISTICS (T<sub>J</sub>= 25 °C unless otherwise specified)

Standard (4 quadrants)						
SYMBOL	TEST CONDITIONS	QUADRANT		25Txxxx		UNIT
				B		
I <sub>GT</sub> <sup>(1)</sup>	V <sub>D</sub> = 12 V, R <sub>L</sub> = 30Ω	I - II - III	MAX.	50		mA
V <sub>GT</sub>		IV		100		
V <sub>GD</sub>	V <sub>D</sub> = V <sub>DRM</sub> , R <sub>L</sub> = 3.3KΩ, T <sub>j</sub> = 125°C	ALL		1.3		V
V <sub>GD</sub>	V <sub>D</sub> = V <sub>DRM</sub> , R <sub>L</sub> = 3.3KΩ, T <sub>j</sub> = 125°C	ALL		0.2		V
I <sub>H</sub> <sup>(2)</sup>	I <sub>T</sub> = 500 mA		MAX.	80		mA
I <sub>L</sub>	I <sub>G</sub> = 1.2 I <sub>GT</sub>	I - III - IV	MAX.	70		mA
		II		160		
dV/dt <sup>(2)</sup>	V <sub>D</sub> = 67% V <sub>DRM</sub> , gate open, T <sub>j</sub> = 125°C		MIN.	500		V/μs
(dV/dt) <sub>c</sub> <sup>(2)</sup>	(dI/dt) <sub>c</sub> = 13.3 A/ms, T <sub>j</sub> = 125°C		MIN.	10		V/μs

**STATIC CHARACTERISTICS**

SYMBOL	TEST CONDITIONS			VALUE	UNIT
V <sub>TM</sub> <sup>(2)</sup>	I <sub>TM</sub> = 35 A, t <sub>p</sub> = 380 μs	T <sub>j</sub> = 25°C	MAX.	1.55	V
V <sub>th</sub> <sup>(2)</sup>	Threshold voltage	T <sub>j</sub> = 125°C	MAX.	0.85	V
R <sub>d</sub> <sup>(2)</sup>	Dynamic resistance	T <sub>j</sub> = 125°C	MAX.	16	mΩ
I <sub>DRM</sub> I <sub>RDM</sub>	V <sub>D</sub> = V <sub>DRM</sub> V <sub>R</sub> = V <sub>RRM</sub>	T <sub>j</sub> = 25°C	MAX.	5	μA
		T <sub>j</sub> = 125°C		3	mA

Note 1: Minimum I<sub>GT</sub> is guaranteed at 5% of I<sub>GT</sub> max.

Note 2: For both polarities of A2 referenced to A1.

**THERMAL RESISTANCE**

SYMBOL			VALUE	UNIT
R <sub>th(j-c)</sub>	Junction to case (AC)	TO-3P	0.6	°C/W
		TO-263/TO-220AB	0.8	
		TO-3P Insulated	0.9	
		TO-220AB Insulated	1.7	
R <sub>th(j-a)</sub>	Junction to ambient	S = 1 cm <sup>2</sup> TO-263	45	
		TO-220AB Insulated, TO-220AB	60	
		TO-3P, TO-3P Insulated	50	

S = Copper surface under tab.

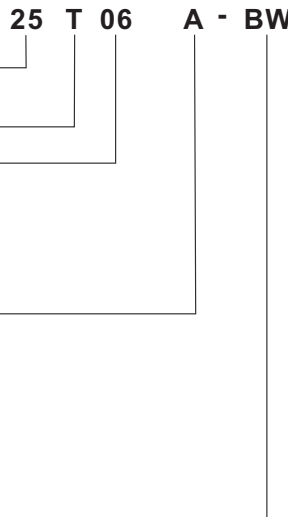
PRODUCT SELECTOR							
PART NUMBER	VOLTAGE (xx)				SENSITIVITY	TYPE	PACKAGE
	600 V	800 V	1000 V	1200 V			
25TxxA-B/25TxxAI-B	V	V	V	V	50 mA	Standard	TO-220AB
25TxxA-CW/25TxxAI-CW	V	V	V	V	35 mA	Snubberless	TO-220AB
25TxxA-BW/25TxxAI-BW	V	V	V	V	50 mA	Snubberless	TO-220AB
25TxxB-B/25TxxBI-B	V	V	V	V	50 mA	Standard	TO-3P
25TxxB-CW/25TxxBI-CW	V	V	V	V	35 mA	Snubberless	TO-3P
25TxxB-BW/25TxxBI-BW	V	V	V	V	50 mA	Snubberless	TO-3P
25TxxH-B	V	V	V	V	50 mA	Standard	D <sup>2</sup> PAK
25TxxH-CW	V	V	V	V	35 mA	Snubberless	D <sup>2</sup> PAK
25TxxH-BW	V	V	V	V	50 mA	Snubberless	D <sup>2</sup> PAK

**AI:** Insulated TO-220AB package

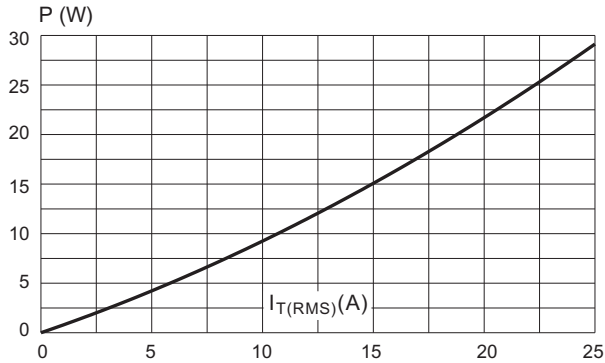
**BI:** Insulated TO-3P package

ORDERING INFORMATION					
ORDERING TYPE	MARKING	PACKAGE	WEIGHT	BASE Q'TY	DELIVERY MODE
25TxxA-yy	25TxxA-yy	TO-220AB	2.0g	50	Tube
25TxxAI-yy	25TxxAI-yy	TO-220AB (insulated)	2.3g	50	Tube
25TxxB-yy	25TxxB-yy	TO-3P	4.3g	30	Tube
25TxxBI-yy	25TxxBI-yy	TO-3P (insulated)	4.8g	30	Tube
25TxxH-yy	25TxxH-yy	D <sup>2</sup> PAK	2.0g	50	Tube

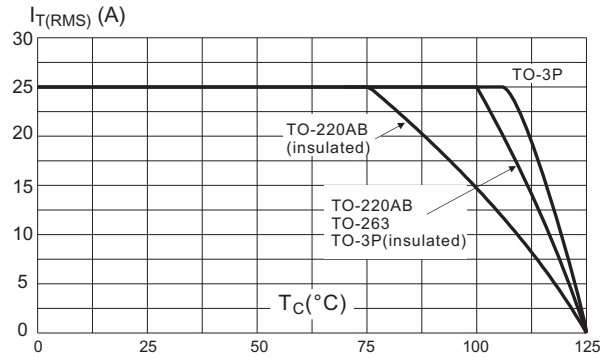
**Note:** xx = voltage, yy = sensitivity

ORDERING INFORMATION SCHEME	
<p><b>Current</b> 25 = 25A</p> <p><b>Triac series</b></p> <p><b>Voltage</b> 06 = 600V 08 = 800V 10 = 1000V 12 = 1200V</p> <p><b>Package type</b> A = TO-220AB (non-insulated) AI = TO-220AB (insulated) B = TO-3P (non-insulated) BI = TO-3P (insulated) H = TO-263 (D<sup>2</sup>PAK)</p> <p><b>I<sub>GT</sub> Sensitivity</b> BW = 50mA Snubberless CW = 35mA Snubberless B = 50mA Standard</p>	<p><b>25 T 06 A - BW</b></p> 

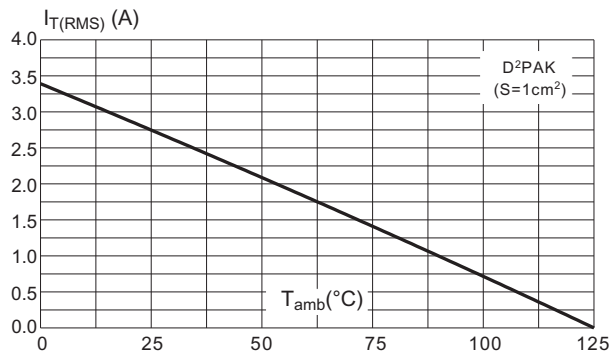
**Fig.1 Maximum power dissipation versus RMS on-state current (full cycle)**



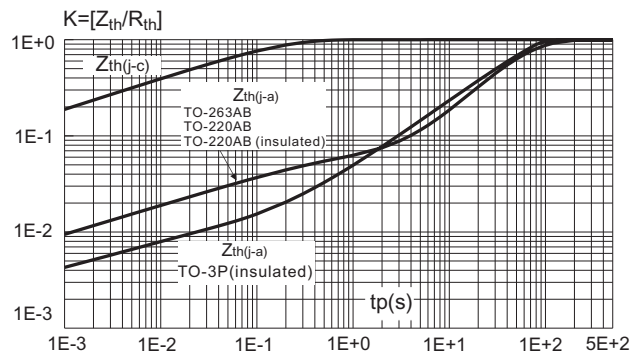
**Fig.2 RMS on-state current versus case temperature (full cycle)**



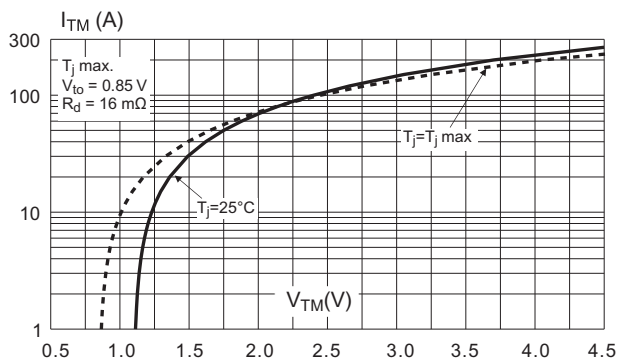
**Fig.3 D<sup>2</sup>PAK RMS on-state current versus ambient temperature (printed circuit board FR4, copper thickness: 35µm)(full cycle)**



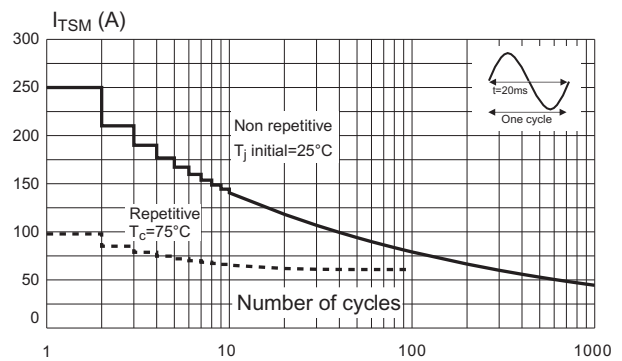
**Fig.4 Relative variation of thermal impedance versus pulse duration.**



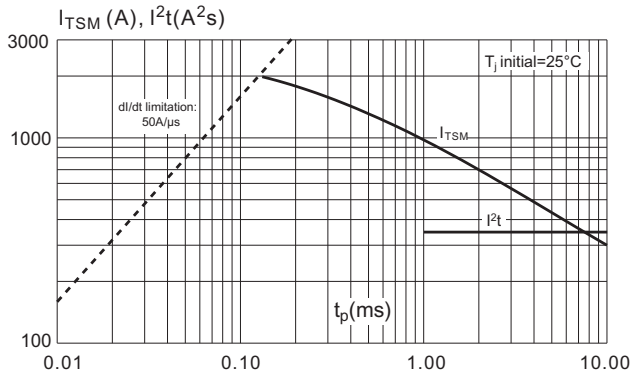
**Fig.5 On-state characteristics (maximum values).**



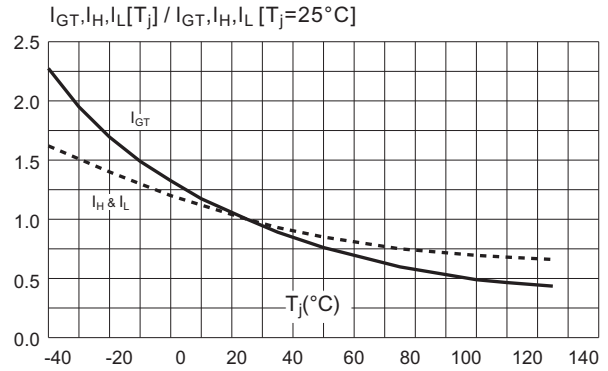
**Fig.6 Surge peak on-state current versus number of cycles.**



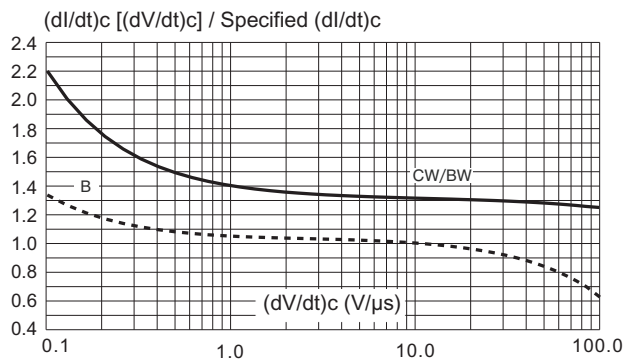
**Fig.7 Non-repetitive surge peak on-state current for a sinusoidal pulse with width  $t_p < 10\text{ms}$ . and corresponding value of  $I^2t$ .**



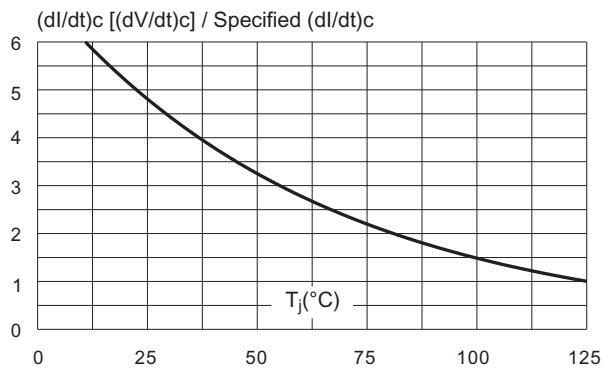
**Fig.8 Relative variation of gate trigger current, holding current and latching current versus junction temperature (typical values).**



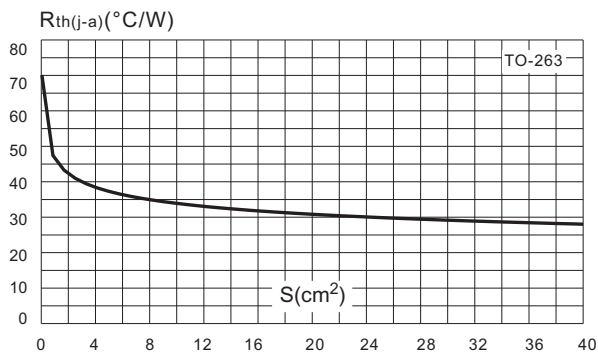
**Fig.9 Relative variation of critical rate of decrease of main current versus  $(dV/dt)_c$  (typical values).**



**Fig.10 Relative variation of critical rate of decrease of main current versus  $T_j$**

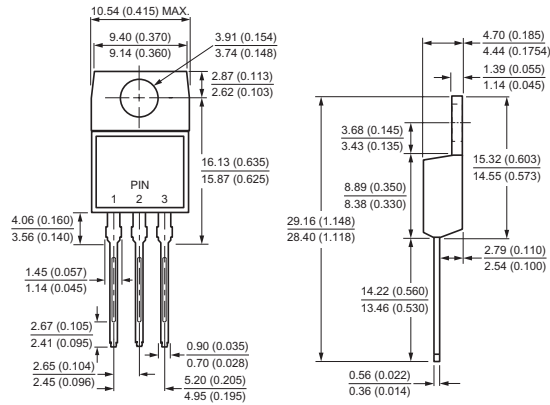


**Fig.11 D<sup>2</sup>PAK thermal resistance junction to ambient versus copper surface under tab (printed circuit board FR4, copper thickness: 35 $\mu$ m)**

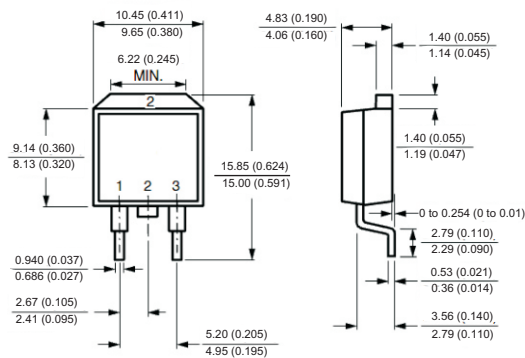


## Case Style

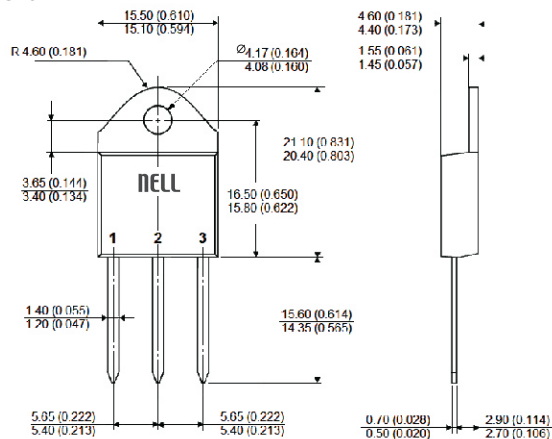
**TO-220AB**



**TO-263(D<sup>2</sup>PAK)**



**TO-3P**



All dimensions in millimeters(inches)

