

572-4835 Insulated solder terminal, Turreted

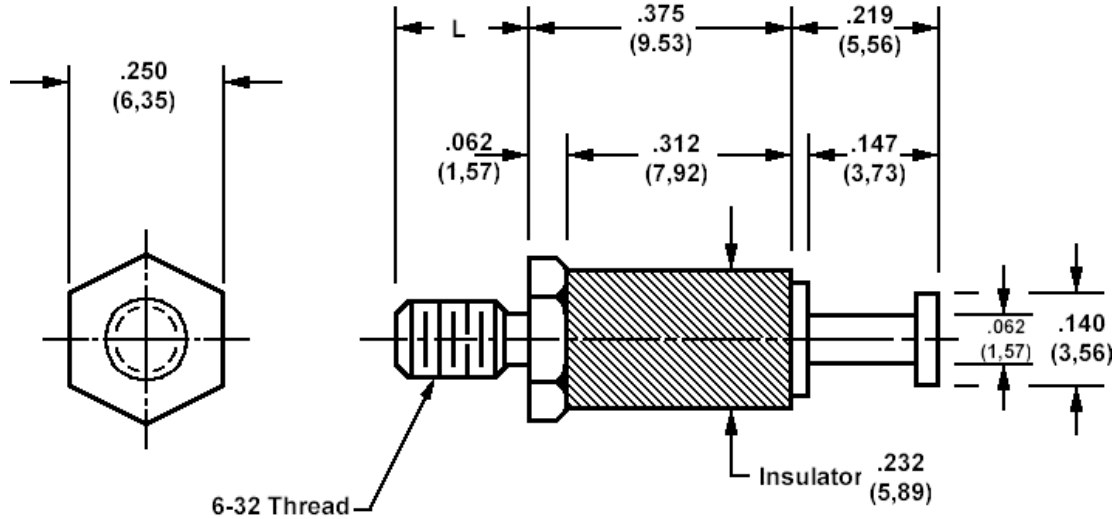

How to order code

572-4835-XX-YY-16

Basic Part No (XX = thread length, YY = plating finish. See tables for options)

Basic Part No.	XX	L
572-4835	-01	.219 (5,56)
	-02	.250 (6,35)
	-03	.375 (9,53)

Component	Material	Finish (YY)	
		-01	-05
Terminal	Brass	Silver	Electro Solder
Stud	Brass	Cadmium (plus chromate)	Cadmium (plus chromate)
Insulator	Diallyl Phthalate (blue)		

Additional Specifications	
Dielectric Withstanding Voltage (VRMS)	6000