

The documentation and process conversion measures necessary to comply with this revision shall be completed by 30 October 1999

INCH-POUND

MIL-PRF-19500/562C  
30 July 1999  
SUPERSEDING  
MIL-S-19500/562B  
7 January 1994

PERFORMANCE SPECIFICATION SHEET

SEMICONDUCTOR DEVICE, FIELD EFFECT TRANSISTOR, P-CHANNEL, SILICON  
TYPES 2N6804 AND 2N6806  
JAN, JANTX, JANTXV, JANS, JANHC, AND JANKC

This specification is approved for use by all Departments and Agencies of the Department of Defense.

1. SCOPE

1.1 Scope. This specification covers the performance requirements for a P-channel, enhancement-mode, MOSFET, power transistor intended for use in high density power switching applications. Four levels of product assurance are provided for each encapsulated device type as specified in MIL-PRF-19500 and two levels of product assurance are provided for each unencapsulated device type.

1.2 Physical dimensions. See figure 1, TO-204AA (formerly TO-3), figures 2 and 3 for JANHC and JANKC die dimensions.

1.3 Maximum ratings. Unless otherwise specified,  $T_A = +25^\circ\text{C}$ .

Type	$P_T$ 1/ $T_C = +25^\circ\text{C}$	$P_T$ $T_A = +25^\circ\text{C}$	$V_{DS}$	$V_{DG}$	$V_{GS}$	$I_{D1}$ 2/ $T_C = +25^\circ\text{C}$	$I_{D2}$ 2/ $T_C = +100^\circ\text{C}$	$I_S$	$I_{DM}$	$T_J$ and $T_{STG}$
	<u>W</u>	<u>W</u>	<u>V dc</u>	<u>V dc</u>	<u>V dc</u>	<u>A dc</u>	<u>A dc</u>	<u>A dc</u>	<u>A(pk)</u>	<u>°C</u>
2N6804	75	4	-100	-100	$\pm 20$	-11.0	-7.0	-11.0	-50	-55 to +150
2N6806	75	4	-200	-200	$\pm 20$	-6.5	-4.0	-6.5	-28	-55 to +150

1/ Derate linearly 0.6 W/°C for  $T_C > +25^\circ\text{C}$ :

$$P_T = \frac{T_{J \max} - T_C}{R_{\theta JC}}$$

$$2/ I_D = \sqrt{\frac{T_{J \max} - T_C}{(R_{\theta JC} \times R_{DS(on)}) \text{ at } T_{J \max}}}$$

Beneficial comments (recommendations, additions, deletions) and any pertinent data which may be of use in improving this document should be addressed to: Commander, Defense Supply Center Columbus, ATTN: DSCC-VAC, 3990 East Broad St., Columbus, OH 43216-5000, by using the addressed Standardization Document Improvement Proposal (DD Form 1426) appearing at the end of this document or by letter.

1.4 Primary electrical characteristics at  $T_C = +25^\circ\text{C}$ .

Type	Min $V_{(BR)DSS}$ $V_{GS} = 0\text{ V}$ $I_D = -1.0\text{ mA dc}$	$V_{GS(th)1}$ $V_{DS} \geq V_{GS}$ $I_D = -0.25\text{ mA dc}$		Max $I_{DSS1}$ $V_{GS} = 0\text{ V}$	Max $r_{DS(on)1}$ <sup>1/</sup> $V_{GS} = -10\text{ V dc}$		$R_{\theta JC}$ maximum
					$V_{DS} = 80$ percent of rated $V_{DS}$	$T_J = +25^\circ\text{C}$ at $I_{D2}$	
	<u>V dc</u>	<u>V dc</u>		<u><math>\mu\text{A dc}</math></u>	<u>ohm</u>	<u>ohm</u>	<u><math>^\circ\text{C/W}</math></u>
		<u>Min</u>	<u>Max</u>				
2N6804	-100	-2.0	-4.0	-25	0.30	0.60	1.67
2N6806	-200	-2.0	-4.0	-25	0.80	1.80	1.67

<sup>1/</sup> Pulsed (see 4.5.1).

## 2. APPLICABLE DOCUMENTS

2.1 General. The documents listed in this section are specified in sections 3 and 4 of this specification. This section does not include documents cited in other sections of this specification or recommended for additional information or as examples. While every effort has been made to ensure the completeness of this list, document users are cautioned that they must meet all specified requirements documents cited in sections 3 and 4 of this specification, whether or not they are listed.

2.2 Government documents.

2.2.1 Specifications, standards, and handbooks. The following specifications, standards, and handbooks form a part of this document to the extent specified herein. Unless otherwise specified, the issues of these documents are those listed in the issue of the Department of Defense Index of Specifications and Standards (DODISS) and supplement thereto, cited in the solicitation (see 6.2).

## SPECIFICATION

## DEPARTMENT OF DEFENSE

MIL-PRF-19500 - Semiconductor Devices, General Specification for.

## STANDARD

## MILITARY

MIL-STD-750 - Test Methods for Semiconductor Devices.

(Unless otherwise indicated, copies of the above specifications, standards, and handbooks are available from the Defense Automated Printing Service, Building 4D (DPM-DODSSP), 700 Robbins Avenue, Philadelphia, PA 19111-5094.)

2.3 Order of precedence. In the event of a conflict between the text of this document and the references cited herein (except for related associated specifications or specification sheets), the text of this document takes precedence. Nothing in this document, however, supersedes applicable laws and regulations unless a specific exemption has been obtained.

## 3. REQUIREMENTS

3.1 Qualification. Devices furnished under this specification shall be products that are authorized by the qualifying activity for listing on the applicable qualified manufacturer's list before contract award (see 4.2 and 6.3).

Symbol	Dimensions				Notes
	Inches		Millimeters		
	Min	Max	Min	Max	
CH	0.250	0.360	6.35	9.15	3
LD	0.038	0.043	0.97	0.110	
CD		0.875		22.23	
PS	0.420	0.440	10.67	11.18	3
PS <sub>1</sub>	0.205	0.225	5.21	5.72	3
HT	0.060	0.135	1.52	3.43	
LL	0.312	0.500	7.92	12.70	
LL <sub>1</sub>		0.050		1.27	
MHD	0.151	0.161	3.84	4.09	
MHS	1.177	1.197	29.90	30.40	
HR	0.495	0.525	12.57	13.34	
HR <sub>1</sub>	0.131	0.188	3.33	4.78	
s <sub>1</sub>	0.655	0.675	16.64	17.15	

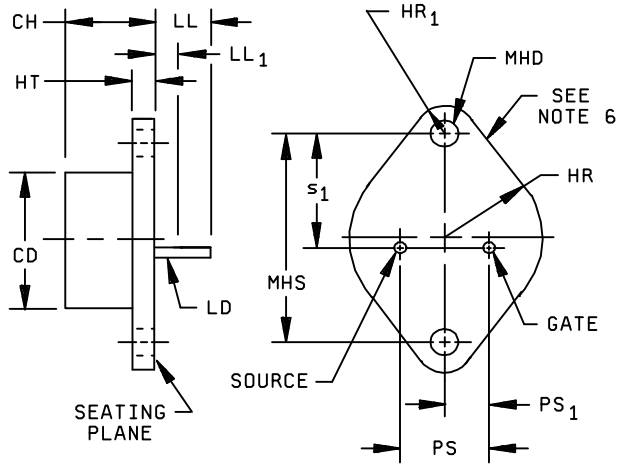
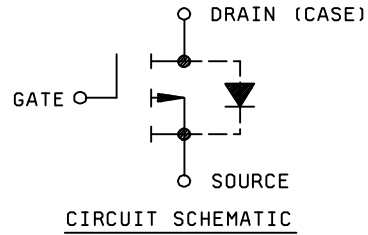

NOTES:

1. Dimensions are in inches.
2. Metric equivalents are given for general information only.
3. These dimensions should be measured at points 0.050 inch (1.27 mm) to 0.055 inch (1.40 mm) below seating plane. Measurement will be made at the seating plane.
4. The seating plane of the header shall be flat within .001 inch (0.03 mm) concave to .004 inch (0.10 mm) convex inside a 0.930 inch (23.62 mm) diameter circle on the center of the header and flat within 0.001 inch (0.03 mm) concave to 0.006 inch (0.15 mm) convex overall.
5. Mounting holes shall be deburred on the seating plane side.
6. Drain is electrically connected to case.

FIGURE 1. Physical dimensions of transistor (TO-204AA).

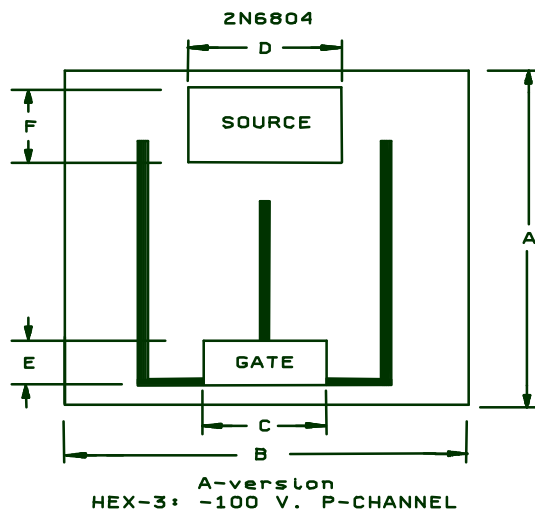

Ltr	Dimensions			
	Inches		Millimeters	
	Min	Max	Min	Max
A	0.172	0.186	4.37	4.72
B	0.106	0.120	2.69	3.05
C	0.021	0.029	0.53	0.74
D	0.035	0.043	0.89	1.09
E	0.014	0.022	0.36	0.56
F	0.025	0.036	0.64	0.91

NOTES:

1. Dimensions are in inches.
2. Metric equivalents are given for general information only.
3. The physical characteristics of the die are:  
 Back metals are chromium, nickel, and silver.  
 Top metal is aluminum  
 Back contact is the drain.
4. The die thickness is 0.0187 inch (0.474 mm), the tolerance is  $\pm 0.0050$  inch (0.13 mm).
5. Unless otherwise specified, tolerance is  $\pm 0.0005$  inch (0.13 mm).

FIGURE 2. JANHCA and JANKCA die dimensions for 2N6804.

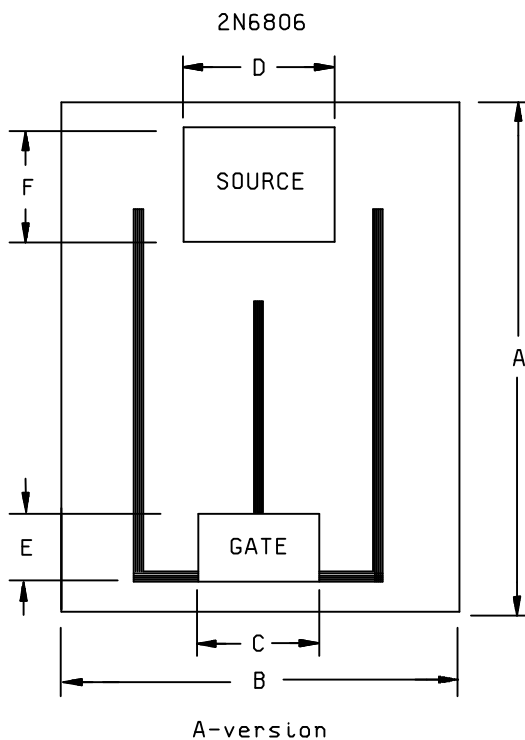

Ltr	Dimensions			
	Inches		Millimeters	
	Min	Max	Min	Max
A	0.173	0.187	4.39	4.75
B	0.108	0.124	2.74	3.15
C	0.022	0.030	0.56	0.76
D	0.030	0.038	0.76	0.97
E	0.012	0.020	0.30	0.51
F	0.021	0.029	0.53	0.74

NOTES:

1. Dimensions are in inches.
2. Metric equivalents are given for general information only.
3. The physical characteristics of the die are:  
 Back metals are chromium, nickel, and silver.  
 Top metal is aluminum  
 Back contact is the drain.
6. The die thickness is 0.0187 inch (0.474 mm), the tolerance is  $\pm 0.0050$  inch (0.13 mm).
7. Unless otherwise specified, tolerance is  $\pm 0.0005$  inch (0.13 mm).

FIGURE 3. JANHCA and JANKCA die dimensions for 2N6806.

3.2 Associated specification. The individual item performance requirements shall be in accordance with MIL-PRF-19500, and as specified herein.

3.3 Abbreviations, symbols, and definitions. Abbreviations, symbols, and definitions used herein shall be as specified in MIL-PRF-19500.

3.4 Interface requirements and physical dimensions. The interface requirements and physical dimensions shall be as specified in MIL-PRF-19500 and on figure 1 (TO-204AA) and figures 2 and 3 (JANH and JANKC) herein.

3.4.1 Lead finish. Lead finish shall be solderable in accordance with MIL-PRF-19500, MIL-STD-750 and herein. Where a choice of lead finish is desired, it shall be specified in the acquisition document (see 6.2).

3.4.2 Internal construction. Multiple chip construction shall not be permitted.

3.5 Marking. Devices shall be marked in accordance with MIL-PRF-19500.

3.6 Electrical performance characteristics. Unless otherwise specified, the electrical performance characteristics are as specified in 1.3, 1.4, and table I herein.

3.7 Electrostatic discharge protection. The devices covered by this specification require electrostatic protection.

3.7.1 Handling. MOS devices must be handled with certain precautions to avoid damage due to the accumulation of static charge. The following handling practices shall be followed:

- a. Devices shall be handled on benches with conductive handling devices.
- b. Ground test equipment, tools, and personnel handling devices.
- c. Do not handle devices by the leads.
- d. Store devices in conductive foam or carriers.
- e. Avoid use of plastic, rubber, or silk in MOS areas.
- f. Maintain relative humidity above 50 percent if practical.
- g. Care shall be exercised, during test and troubleshooting, to apply not more than maximum rated voltage to any lead.
- h. Gate must be terminated to source,  $R \leq 100 \text{ k}$ , whenever bias voltage is to be applied drain to source.

3.8 Electrical test requirements. The electrical test requirements shall be the subgroups specified in table I.

3.9 Qualification. Devices furnished under this specification shall be products that are authorized by the qualifying activity for listing on the applicable qualified products list before contract award (see 4.2 and 6.3 ).

#### 4. VERIFICATION

4.1 Classification of Inspections. The inspection requirements specified herein are classified as follows:

- a. Qualification inspection (see 4.2).
- b. Screening (see 4.3)
- c. Conformance inspection (see 4.4).

4.2 Qualification inspection. Qualification inspection shall be in accordance with MIL-PRF-19500 and herein. Alternate flow is allowed for qualification inspection in accordance with figure 4 of MIL-PRF-19500.

4.2.1 Group E inspection. Group E inspection shall be conducted in accordance with MIL-PRF-19500 and herein.

4.3 Screening (JANS, JANTX, and JANTXV levels only). Screening shall be in accordance with table IV of MIL-PRF-19500 and as specified herein. The following measurements shall be made in accordance with table I herein. Devices that exceed the limits of table I herein shall not be acceptable.

Screen (see table IV of MIL-PRF-19500)	Measurement	
	JANS level	JANTX and JANTXV levels
<u>1</u> /	Gate stress test (see 4.5.5)	Gate stress test (see 4.5.5)
<u>1</u> /	Method 3161 (see 4.5.3)	Method 3161 (see 4.5.3)
<u>2</u> /	Method 3470 (optional)	Method 3470 (optional)
3	Test condition G	Test condition G
9 <u>1</u> /	$I_{GSS1}$ , $I_{DSS1}$ , Subgroup 2 of table I herein.	Subgroup 2 of table I herein.
10	Method 1042, test condition B	Method 1042, test condition B
11	$I_{GSS1}$ , $I_{DSS1}$ , $r_{DS(on)1}$ , $V_{GS(th)1}$ , subgroup 2 of table I herein; $\Delta I_{GSS1} = \pm 20$ nA dc or $\pm 100$ percent of initial value, whichever is greater. $\Delta I_{DSS1} = \pm 25$ $\mu$ A dc or $\pm 100$ percent of initial value, whichever is greater.	$I_{GSS1}$ , $I_{DSS1}$ , $r_{DS(on)1}$ , $V_{GS(th)1}$ , subgroup 2 of table I herein;
12	Method 1042, test condition A, $t = 240$ hours	Method 1042, test condition A; $T_A = +175^{\circ}\text{C}$ and $t = 48$ hours
13	Subgroups 2 and 3 of table I herein; $\Delta I_{GSS1} = \pm 20$ nA dc or $\pm 100$ percent of initial value, whichever is greater. $\Delta I_{DSS1} = \pm 25$ $\mu$ A dc or $\pm 100$ percent of initial value, whichever is greater. $\Delta r_{DS(on)1} = \pm 20$ percent of initial value. $\Delta V_{GS(th)1} = \pm 20$ percent of initial value.	Subgroups 2 of table I herein; $\Delta I_{GSS1} = \pm 20$ nA dc or $\pm 100$ percent of initial value, whichever is greater. $\Delta I_{DSS1} = \pm 25$ $\mu$ A dc or $\pm 100$ percent of initial value, whichever is greater. $\Delta r_{DS(on)1} = \pm 20$ percent of initial value. $\Delta V_{GS(th)1} = \pm 20$ percent of initial value.

1/ Shall be performed anytime before screen 10.

2/ Method 3470 is optional if performed as a sample in group A, subgroup 5.

4.3.1 Screening (JANHC and JANKC). Screening of die shall be in accordance with MIL-PRF-19500. As a minimum, die shall be 100-percent probed in accordance with group A, subgroup 2.

4.4 Conformance inspection. Conformance inspection shall be in accordance with MIL-PRF-19500. Alternate flow is allowed for quality conformance inspection in accordance with figure 4 of MIL-PRF-19500.

4.4.1 Group A inspection. Group A inspection shall be conducted in accordance with MIL-PRF-19500 and table I herein. Electrical measurements (end-points) shall be in accordance with subgroup 2 of table I herein

4.4.2 Group B inspection. Group B inspection shall be conducted in accordance with the conditions specified for subgroup testing in table VIa (JANS) and table VIb (JAN, JANTX, and JANTXV) of MIL-PRF-19500 and herein. Electrical measurements (end-points) shall be in accordance with subgroup 2 of table I herein.

4.4.2.1 Group B inspection table VIa (JANS) of MIL-PRF-19500.

Subgroup	Method	Conditions
3	1051	Test condition G.
4	1042	Test condition D; 2,000 cycles. The heating cycle shall be 1 minute minimum.
5	1042	Accelerated steady-state operation life; test condition A; $V_{DS} = \text{rated}$ $T_A = +175^\circ\text{C}$ , $t = 120$ hours  Accelerated steady-state gate stress; condition B, $V_{GS} = \text{rated}$ , $T_A = +175^\circ\text{C}$ , $t = 24$ hours. End point delta measurements (see 4.5.3 herein)
5	2037	Bond strength (Al-Au die interconnects only); test condition A.
6	3161	See 4.5.2.

4.4.2.2 Group B inspection, table VIb (JAN, JANTX and JANTXV) of MIL-PRF-19500.

<u>Subgroup</u>	<u>Method</u>	<u>Condition</u>
2	1051	Test condition G.
3	1042	Test condition D, 2,000 cycles. The heating cycle shall be 1 minute minimum. End point delta measurements (see 4.5.3 herein)
3	2037	Test condition A. All internal bond wires for each device shall be pulled separately.

4.4.3 Group C inspection. Group C inspection shall be conducted in accordance with the conditions specified for subgroup testing in table VII of MIL-PRF-19500 and as follows. Electrical measurements (end-points) shall be in accordance with subgroup 2 of table I herein.

<u>Subgroup</u>	<u>Method</u>	<u>Condition</u>
2	2036	Test condition A; weight = 10 pounds; $t = 15$ s.
6	1042	Test condition D, 6,000 cycles. The heating cycle shall be 1 minute minimum. End point delta measurements (see 4.5.3 herein)

4.4.4 Group E inspection. Group E inspection shall be conducted in accordance with the conditions specified for subgroup testing in table IX of MIL-PRF-19500 and as follows. Electrical measurements (end-points) shall be in accordance with subgroup 2 of table I herein.



4.4.1 Group E inspection, table IX of MIL-PRF-19500. JANHC and JANKC devices are qualified in accordance with MIL-PRF-19500.

<u>Subgroup</u>	<u>Method</u>	<u>Condition</u>	<u>Sampling plan</u>
E1	1051	Test Condition G, 500 cycles	45 devices, c = 0
E2 <u>1/</u>	1042	Test condition A, 1,000 hours.	45 devices, c = 0
E2 <u>1/</u>	1042	Test condition B, 1,000 hours.	45 devices, c = 0
E3		Not applicable	
E4	3161	R <sub>θJC</sub> see 1.67°C/W maximum, see 4.5.2	5 devices, c = 0
E5		Not applicable	

1/ A separate sample may be pulled for each test.

4.5 Methods of inspection. Methods of inspection shall be as specified in the appropriate tables and as follows.

4.5.1 Pulse measurements. Conditions for pulse measurement shall be as specified in section 4 of MIL-STD-750.

4.5.2 Thermal resistance. Thermal resistance measurements shall be performed in accordance with method 3161 of MIL-STD-750.

R<sub>θJC(max)</sub> = 1.67°C/W.

- a. Measuring current (I<sub>M</sub>) .....10 mA.
- b. Drain heating current (I<sub>H</sub>).....4 A.
- c. Heating time (t<sub>H</sub>) .....Steady-state (see MIL-STD-750, method 3161 for definition).
- d. Drain-source heating voltage (V<sub>H</sub>) .....25 V.
- e. Measurement time delay (t<sub>MD</sub>).....10 to 60 μs.
- f. Sample window time (t<sub>SW</sub>) .....10 μs maximum.

4.5.3 Thermal impedance (Z<sub>θJC</sub> measurements). The Z<sub>θJC</sub> measurements shall be performed in accordance with MIL-STD-750, method 3161. The maximum limit (not to exceed figure 4, thermal impedance curves and the group A, subgroup 2 limits) for Z<sub>θJC</sub> in screening (table IV of MIL-PRF-19500) shall be derived by each vendor by means of statistical process control. When the process has exhibited control and capability, the capability data shall be used to establish the fixed screening limit. In addition to screening, once a fixed limit has been established, monitor all future sealing lots using a random five piece sample from each lot to be plotted on the applicable X, R chart. If a lot exhibits an out of control condition, the entire lot shall be removed from the line and held for Engineering evaluation and disposition. This procedure may be used in lieu of an inline process monitor.

- a. Measuring current (I<sub>M</sub>) .....10 mA.
- b. Drain heating current (I<sub>H</sub>).....4 A minimum.
- c. Heating time (t<sub>H</sub>) .....100 ms.
- d. Drain-source heating voltage (V<sub>H</sub>) .....25 V minimum.
- e. Measurement time delay (t<sub>MD</sub>).....30 to 60 μs.
- f. t<sub>SW</sub> sample window time .....10 μs (maximum).

4.5.4 Unclamped inductive switching.

- a. Peak current ( $I_D$ ).....Rated  $I_{D1}$ .
- b. Peak gate voltage ( $V_{GS}$ ) .....-10 V.
- c. Gate to source resistor ( $R_{GS}$ ) ..... $25 \Omega \leq R_{GS} \leq 200 \Omega$ .
- d. Initial case temperature ( $T_C$ ).....+25°C +10°C, -5°C.
- e. Inductance (L).....100  $\mu$ H  $\pm$ 10 percent.
- f. Number of pulses to be applied .....1 pulse minimum.
- g. Pulse repetition rate .....None.

4.5.5 Gate stress test.

$V_{GS} = \pm 30$  V minimum.

$t = 250 \mu$ s minimum.

TABLE I. Group A inspection.

Inspection <u>1</u> /	MIL-STD-750		Symbol	Limits		Unit
	Method	Conditions		Min	Max	
<u>Subgroup 1</u>						
Visual and mechanical inspection	2071					
<u>Subgroup 2</u>						
Thermal impedance <u>2</u> /	3161	See 4.5.3	$Z_{\theta JC}$		1.2	$^{\circ}C/W$
Breakdown voltage, drain to source	3407	$V_{GS} = 0 V$ ; $I_D = -1.0$ mA dc Bias condition C	$V_{(BR)DSS}$			V dc
2N6804 2N6806				-100 -200		
Gate to source voltage (threshold)	3403	$V_{DS} \geq V_{GS}$ ; $I_D = -0.25$ mA dc	$V_{GS(th)1}$	-2.0	-4.0	V dc
Gate reverse current	3411	Bias condition C; $V_{DS} = 0 V$ ; $V_{GS} = +20$ and $-20$ V dc	$I_{GSS1}$		$\pm 100$	nA dc
Drain current	3413	$V_{GS} = 0$ ; bias condition C; $V_{DS} = 0 V$ ; $V_{DS} = 80$ percent of rated $V_{DS}$	$I_{DSS1}$		-25	$\mu A$ dc
Static drain to source on-state resistance	3421	$V_{GS} = -10$ V dc; condition A, pulsed (see 4.5.1)	$r_{DS(on)1}$			$\Omega$
2N6804 2N6806		$I_D = -7$ A dc $I_D = -4$ A dc			0.30 0.80	
Drain to source on-state resistance	3421	$V_{GS} = -10$ V dc; condition A, pulsed (see 4.5.1)	$r_{DS(on)2}$			$\Omega$
2N6804 2N6806		$I_D = -11$ A dc $I_D = -6.5$ A dc			0.36 0.94	
Forward voltage (source drain diode)	4011	Pulsed (see 4.5.1), $V_{GS} = 0 V$	$V_{SD}$			
2N6804 2N6806		For devices with a multiple diode structure $I_S = -11$ A dc $I_S = -6.5$ A dc			-4.7 -6.0	V V

See footnote at end of table.

TABLE I. Group A inspection - Continued.

Inspection 1/	MIL-STD-750		Symbol	Limits		Unit
	Method	Conditions		Min	Max	
<u>Subgroup 3</u>						
High temperature operation:						
Gate reverse current	3411	Bias condition C, $V_{DS} = 0$ V $V_{GS} = +20$ V dc and $-20$ V dc	$I_{GSS2}$		$\pm 200$	nA dc
Drain current	3413	Bias condition C, $V_{GS} = 0$ V $V_{DS} = 80$ percent rated $V_{DS}$	$I_{DSS2}$		$-0.25$	mA dc
Gate to source voltage (threshold)	3403	$V_{DS} \geq V_{GS}$ ; $I_D = -0.25$ mA	$V_{GS(th)2}$	$-1.0$		V dc
Static drain to source on-state resistance	3421	$V_{GS} = -10$ V dc, Pulsed (see 4.5.1)	$r_{DS(on)3}$			$\Omega$
2N6804		$I_D = -7$ A dc			0.55	
2N6806		$I_D = -4$ A dc			1.60	
Low temperature operation:						
Gate to source voltage (threshold)	3403	$V_{DS} \geq V_{GS}$ ; $I_D = -0.25$ mA	$V_{GS(th)3}$		$-5.0$	V dc
<u>Subgroup 4</u>						
Switching time test	3472	$I_D =$ rated $I_{D2}$ (see 1.3); $V_{GS} = -10$ V dc; $R_g = 7.5$ ohms				
Turn-on delay time			$t_{d(on)}$			ns
2N6804		$V_{DD} = -35$ V dc			60	
2N6806		$V_{DD} = -63$ V dc			50	
Rise time			$t_r$			ns
2N6804		$V_{DD} = -35$ V dc			140	
2N6806		$V_{DD} = -63$ V dc			100	

See footnote at end of table.

TABLE I. Group A inspection - Continued.

Inspection 1/	MIL-STD-750		Symbol	Limits		Unit
	Method	Conditions		Min	Max	
<u>Subgroup 4</u> – Continued						
Turn-off delay time			$t_{d(off)}$			ns
2N6804		$V_{DD} = -35$ V dc		140		
2N6806		$V_{DD} = -63$ V dc		100		
Fall time			$t_f$			ns
2N6804		$V_{DD} = -35$ V dc		140		
2N6806		$V_{DD} = -63$ V dc		80		
<u>Subgroup 5</u>						
Single pulse unclamped inductive switching 3/	3470	See 4.5.4, 116 devices, c = 0				
Electrical measurements		See table I, subgroup 2 herein.				
Safe operating area test	3474	$V_{DS} = 80$ percent of rated $V_{DS}$ ; $V_{DS} \leq 200$ V maximum, $t_p = 10$ ms (see figure 5).				
Electrical measurements		See table I, subgroup 2 herein.				
<u>Subgroup 6</u>						
Not applicable						
<u>Subgroup 7</u>						
Gate charge	3471	Condition B				
<u>Test 1</u>						
On-state gate charge			$Q_{g(on)}$			nC
2N6804				29.0		
2N6806				31.0		
<u>Test 2</u>						
Gate to source charge			$Q_{gs}$			
2N6804				7.1		
2N6806				7.0		

See footnote at end of table.

TABLE I. Group A inspection - Continued.

Inspection <sup>1/</sup>	MIL-STD-750		Symbol	Limits		Unit
	Method	Conditions		Min	Max	
<u>Subgroup 7</u> – Continued						
<u>Test 3</u> Gate to drain charge			$Q_{gd}$		21.0 17.0	nC
2N6804 2N6806						
Reverse recovery time	3473	$V_{DD} \leq -50 V$	$t_{rr}$		250 400	ns
2N6804 2N6806		$di/dt \leq -100 A/\mu s; I_F = -11 A$ $di/dt \leq -100 A/\mu s; I_F = -6.5 A$				

<sup>1/</sup> For sampling plan, see MIL-PRF-19500.

<sup>2/</sup> This test is required for the following endpoint measurements only ( not intended for screen 13):

JANS – group B, subgroups 3 and 4.  
 JANTX and JANTXV - group B, subgroups 2 and 3.  
 group C, subgroup 6.  
 group E, subgroup 1.

<sup>3/</sup> This test is optional if performed as a 100 percent screen.

2N6804 and 2N6806

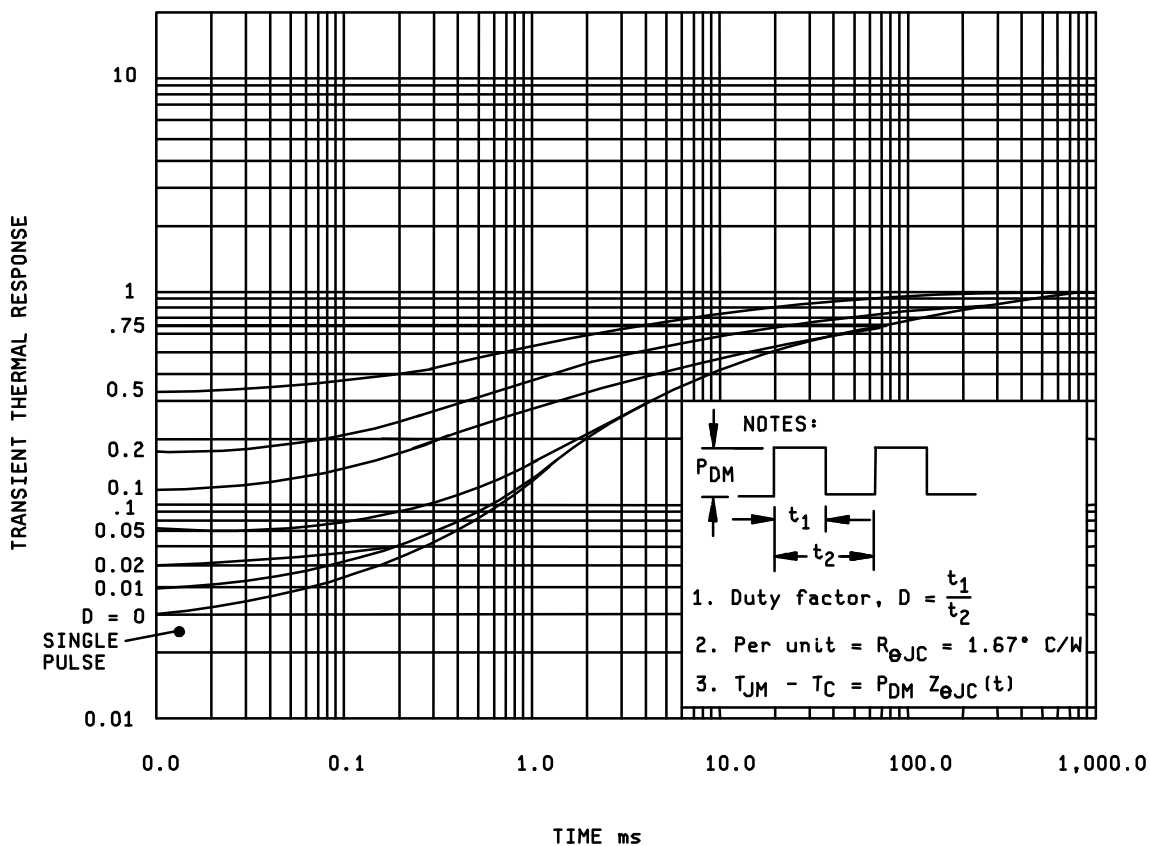

NOTE: These curves refer to devices packaged in a T0-204AA package only.

FIGURE 4. Transient thermal impedance.

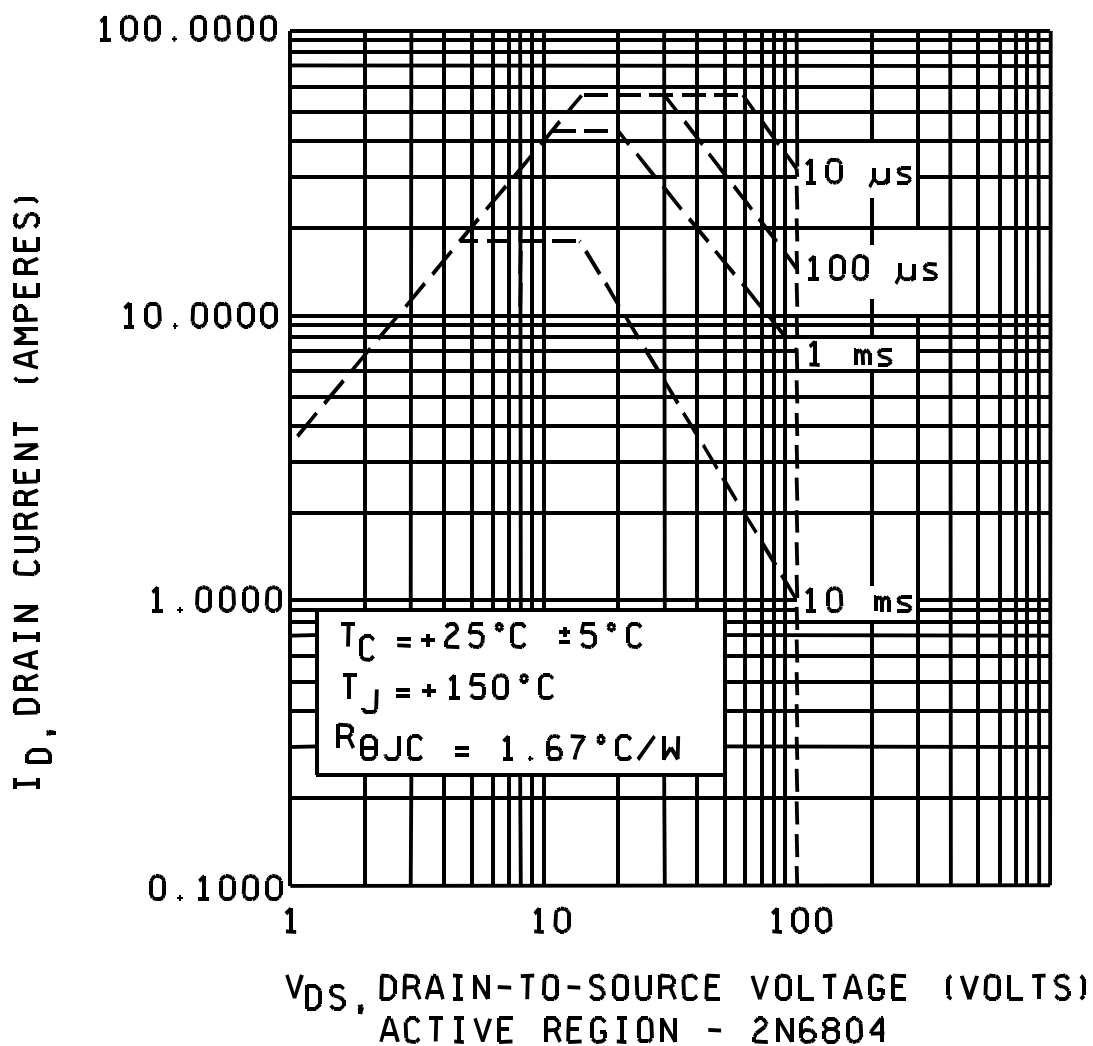

NOTE: These curves refer to devices packaged in a T0-204AA package only.

FIGURE 5. Maximum safe operating area.



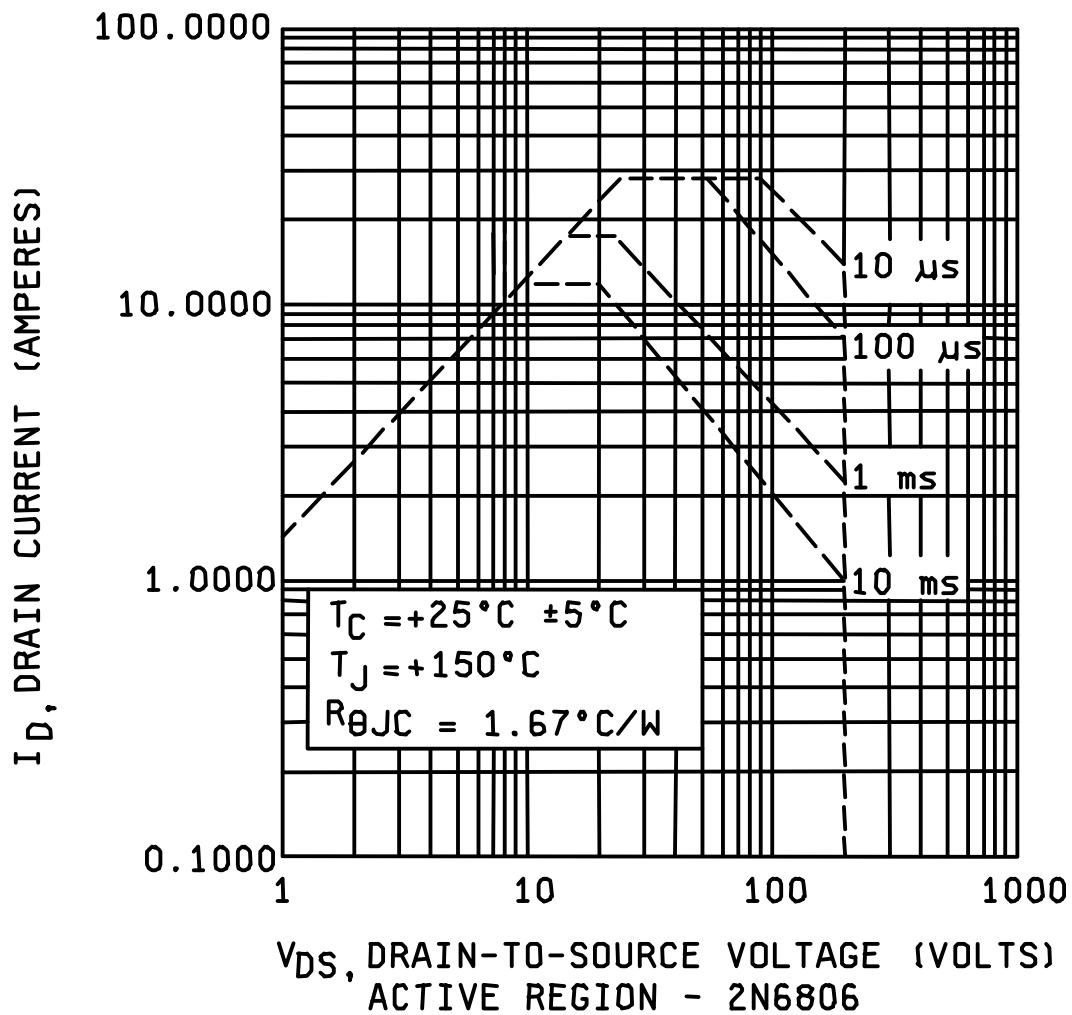

NOTE: These curves refer to devices packaged in a T0-204AA package only.

FIGURE 5. Maximum safe operating area - Continued.

## 5. PACKAGING

5.1 Packaging. For acquisition purposes, the packaging requirements shall be as specified in the contract or order (see 6.2). When actual packaging of material is to be performed by DoD personnel, these personnel need to contact the responsible packaging activity to ascertain requisite packaging requirements. Packaging requirements are maintained by the Inventory Control Points' packaging activity within the Military Department or Defense Agency, or within the Military Departments' System Command. Packaging data retrieval is available from the managing Military Departments' or Defense Agency's automated packaging files, CD-ROM products, or by contacting the responsible packaging activity.

## 6. NOTES

(This section contains information of a general or explanatory nature that may be helpful, but is not mandatory.)

6.1 Notes. The notes specified in MIL-PRF-19500 are applicable to this specification.

6.2 Acquisition requirements. Acquisition documents must specify the following:

- a. Issue of DODISS to be cited in the solicitation (see 2.2.1).
- b. The lead finish as specified (see 3.4.1).
- c. Type designation and quality assurance level.
- c. Packaging requirements (see 5.1).
- e. For die acquisition, the JANHC or JANKC letter version shall be specified (see figures 2 and 3).

6.3 Qualification. With respect to products requiring qualification, awards will be made only for products which are, at the time of award of contract, qualified for inclusion in Qualified Manufacturer's List QML-19500 whether or not such products have actually been so listed by that date. The attention of the contractors is called to these requirements, and manufacturers are urged to arrange to have the products that they propose to offer to the Federal Government tested for qualification in order that they may be eligible to be awarded contracts or purchase orders for the products covered by this specification. Information pertaining to qualification of products may be obtained from Defense Supply Center Columbus, DSCC-VQE, Columbus, OH 43216.

6.4 Cross-reference and complement list. Parts from this specification may be used to replace the following commercial Part or Identifying Number (PIN's). The term Part or Identifying Number (PIN) is equivalent to the term part number which was previously used in this specification.

Preferred types	Commercial types	Complement
2N6804	IRF9130, IRF9131, IRF9132, IRF9133	2N6756
2N6806	IRF9230, IRF9231, IRF9232, IRF9233	2N6758

6.5 Suppliers of JANHC and JANKC die. The qualified die suppliers with the applicable letter version (example JANHCA2N6804) will be identified on the QML.

6.6 Changes from previous issue. Marginal notations are not used in this revision to identify changes with respect to the previous issue due to the extensiveness of the changes.

Custodians:

Army - CR  
Navy - EC  
Air Force - 11  
NASA - NA  
DLA - CC

Preparing activity:

DLA - CC  
(Project 5961- 2083)

Review activities:

Navy - TD  
Air Force - 19, 70, 80

**STANDARDIZATION DOCUMENT IMPROVEMENT PROPOSAL**

**INSTRUCTIONS**

1. The preparing activity must complete blocks 1, 2, 3, and 8. In block 1, both the document number and revision letter should be given.
2. The submitter of this form must complete blocks 4, 5, 6, and 7.
3. The preparing activity must provide a reply within 30 days from receipt of the form.

NOTE: This form may not be used to request copies of documents, nor to request waivers, or clarification of requirements on current contracts. Comments submitted on this form do not constitute or imply authorization to waive any portion of the referenced document(s) or to amend contractual requirements.

<b>I RECOMMEND A CHANGE:</b>	<b>1. DOCUMENT NUMBER</b> MIL-PRF-19500/562C	<b>2. DOCUMENT DATE (YYMMDD)</b> 990730
------------------------------	---	--

**3. DOCUMENT TITLE** SEMICONDUCTOR DEVICE, FIELD EFFECT TRANSISTOR, P-CHANNEL, SILICON TYPES 2N6804, 2N6806, JAN, JANTX, JANTXV, JANS, JANHC, AND JANKC

**4. NATURE OF CHANGE (Identify paragraph number and include proposed rewrite, if possible. Attach extra sheets as needed.)**

**5. REASON FOR RECOMMENDATION**

**6. SUBMITTER**

a. NAME (Last, First, Middle initial)	b. ORGANIZATION		
c. ADDRESS (Include Zip Code)	d. TELEPHONE (Include Area Code)		7. DATE SUBMITTED (YYMMDD)
	Commercial		
	DSN		
	FAX		
	EMAIL		

**8. PREPARING ACTIVITY**

a. Point of contact: Alan Barone	b. TELEPHONE		
	Commercial	DSN	FAX
	614-692-0510	850-0510	614-692-6939
			EMAIL
			alan_barone@dscclia.mil
c. ADDRESS: Defense Supply Center Columbus, ATTN: DSCC-VAC, 3990 East Broad Street, Columbus, OH 43216-5000	<b>IF YOU DO NOT RECEIVE A REPLY WITHIN 45 DAYS, CONTACT:</b>		
	Defense Standardization Program Office (DLSC-LM) 8725 John J. Kingman, Suite 2533, Fort Belvoir, VA 22060-6221 Telephone (703) 767-6888 DSN 427-68880		