

## 16 bits, Fixed-point Digital Signal Processor

$\mu$ PD77018A, 77019 are 16 bits fixed-point DSPs (Digital Signal Processors) developed for digital signal processing with its demand for high speed and precision.

Maximum operating speed of the  $\mu$ PD77018A, 77019 is improved compared with the  $\mu$ PD77015, 77017, 77018. And the  $\mu$ PD77019 internal instruction RAM (4K  $\times$  32 bits) is suitable for program code replacement.

### FEATURES

#### • FUNCTIONS

★

- Instruction cycle: 16.6 ns (MIN.)
  - Operation clock: 60 MHz
  - External clock: 60, 30, 20, 15, 7.5 MHz
  - Crystal: 60 MHz
- On-chip PLL to provide higher operation clock than the external clock
- Dual load/store
- Hardware loop function
- Conditional execution
- Executes product-sum operation in one instruction cycle

#### • PROGRAMMING

- 16 bits  $\times$  16 bits + 40 bits  $\rightarrow$  40 bits multiply accumulator
- 8 general registers (40 bits each)
- 8 ROM/RAM data pointer: each data memory area has 4 registers
- 10 source interrupts (external: 4, internal: 6)
- 3 operand instructions (example:  $R0 = R0 + R1L * R2L$ )
- Nonpipeline on execution stage

#### • MEMORY AREAS

- Instruction memory area : 64K words  $\times$  32 bits
- Data memory areas : 64K words  $\times$  16 bits  $\times$  2 (X memory, Y memory)

**In this document, all descriptions of the  $\mu$ PD77018A also apply to the  $\mu$ PD77019, unless otherwise specified.**

The information in this document is subject to change without notice.

- **CLOCK GENERATOR**
  - Mask option for CLKOUT pin:
    - Fixed to the low level.
    - Does not output the internal system clock.
  - Selectable source clock: external clock input and crystal resonator
    - [External clock]
- ★ On-chip PLL to provide higher operation clock (60 MHz max.) than the external clock.
  - Variable multiple rates (1, 2, 3, 4, 8) by mask option.
  - [Crystal resonator]
    - Oscillation frequency corresponds directly to the system clock frequency (Sure to specify the mask option frequency multiple as "1").
- **ON-CHIP PERIPHERAL**
  - I/O port: 4 bits
  - Serial I/O (16 bits): 2 channels
  - Host I/O (8 bits): 1 channel
- CMOS
- +3 V single power supply

**ORDERING INFORMATION**

Part Number	Package
μPD77018AGC-xxx-9EU	100-pin plastic TQFP (FINE PITCH) (14 × 14 mm)
μPD77019GC-xxx-9EU	100-pin plastic TQFP (FINE PITCH) (14 × 14 mm)

**Remark** xxx indicates a code suffix.

BLOCK DIAGRAM

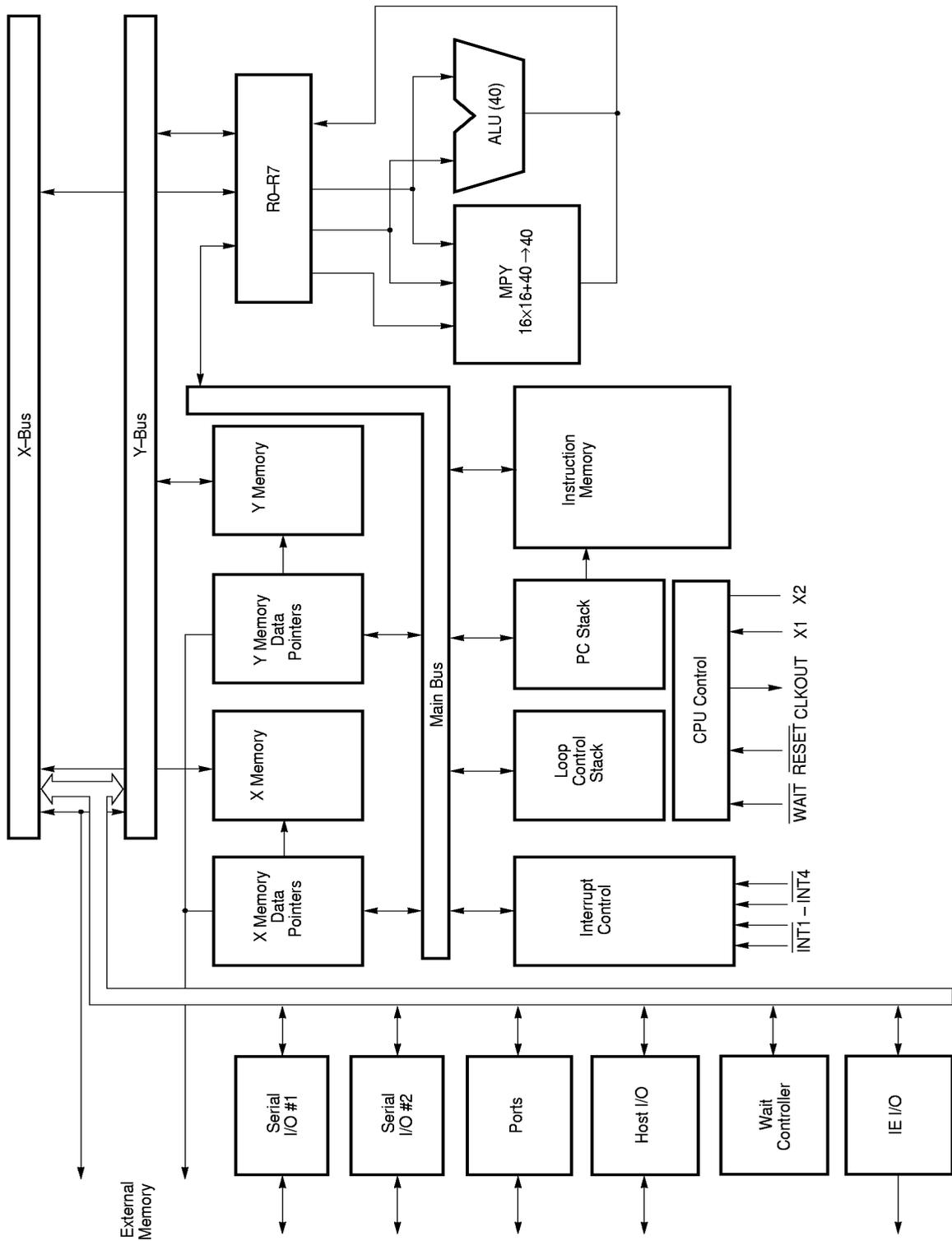

FUNCTIONAL PIN GROUPS

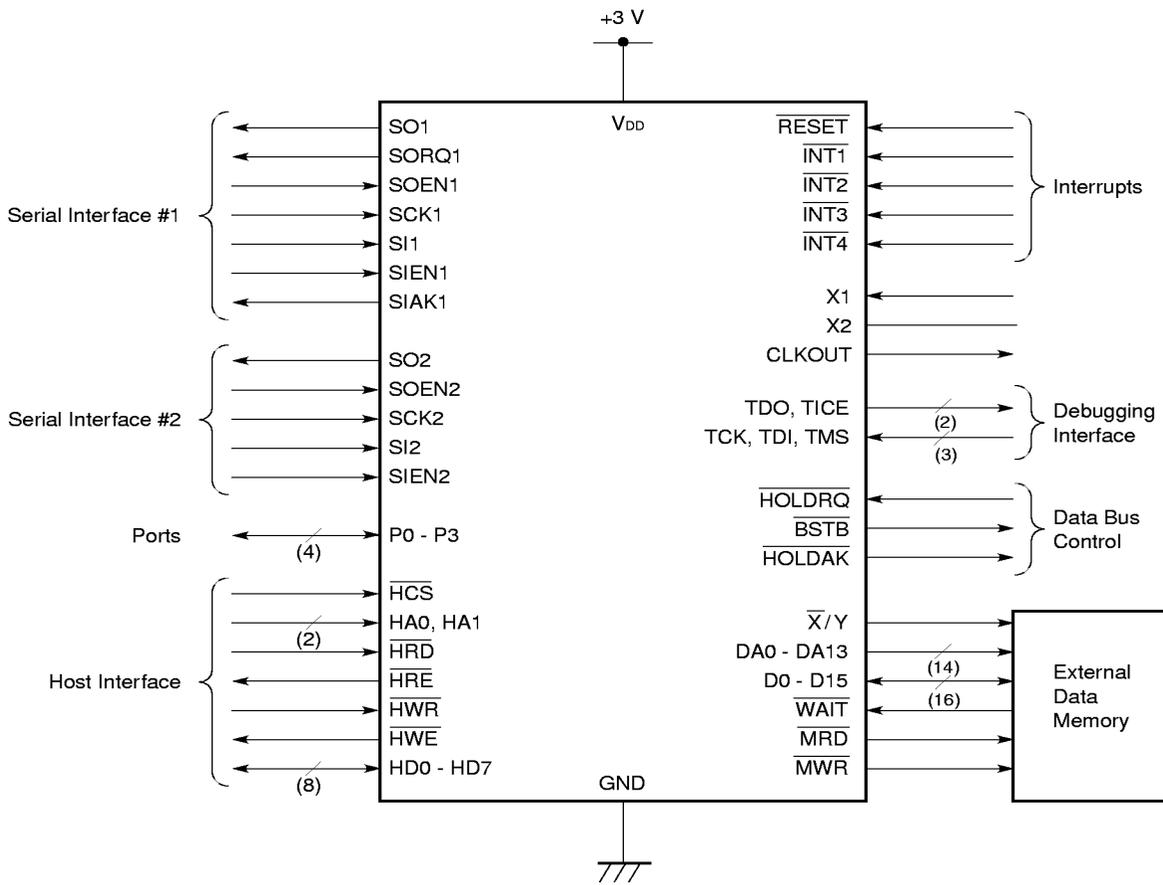

Functional Differences among the μPD7701× Family

Item	μPD77016	μPD77015	μPD77017	μPD77018	μPD77018A	μPD77019	
Internal instruction RAM	1.5K words	256 words					4K words
Internal instruction ROM	None	4K words	12K words	24K words			
External instruction memory	48K words	None					
Data RAM (X/Y memory)	2K words each	1K words each	2K words each	3K words each			
Data ROM (X/Y memory)	None	2K words each	4K words each	12K words each			
External data memory	48K words each	16K words each					
Instruction cycle (Maximum operation speed)		30 ns (33 MHz)			16.6 ns (60 MHz)		
External clock (at maximum operation speed)	66 MHz	33/16.5/8.25/4.125 MHz			60/30/20/15/7.5 MHz		
Crystal (at maximum operation speed)	-	Variable multiple rate (1, 2, 4, 8) by mask option.			Variable multiple rate (1, 2, 3, 4, 8) by mask option.		
Crystal (at maximum operation speed)	-	33 MHz			60 MHz		
Instruction	-	STOP instruction is added.					
Serial interface (2 Channels)	Channel 1 has the same functions as channel 2.	Channel 1 has the same functions as that of the μPD77016. Channel 2 has no SORQ2 or SIAK2 pin (Channel 2 is used for CODEC connection).					
Power supply	5V	3 V					
Package	160-pin plastic QFP	100-pin plastic TQFP					

★

★

★

PIN CONFIGURATION

100-pin plastic TQFP (FINE PITCH) (14 × 14 mm ) (Top View)

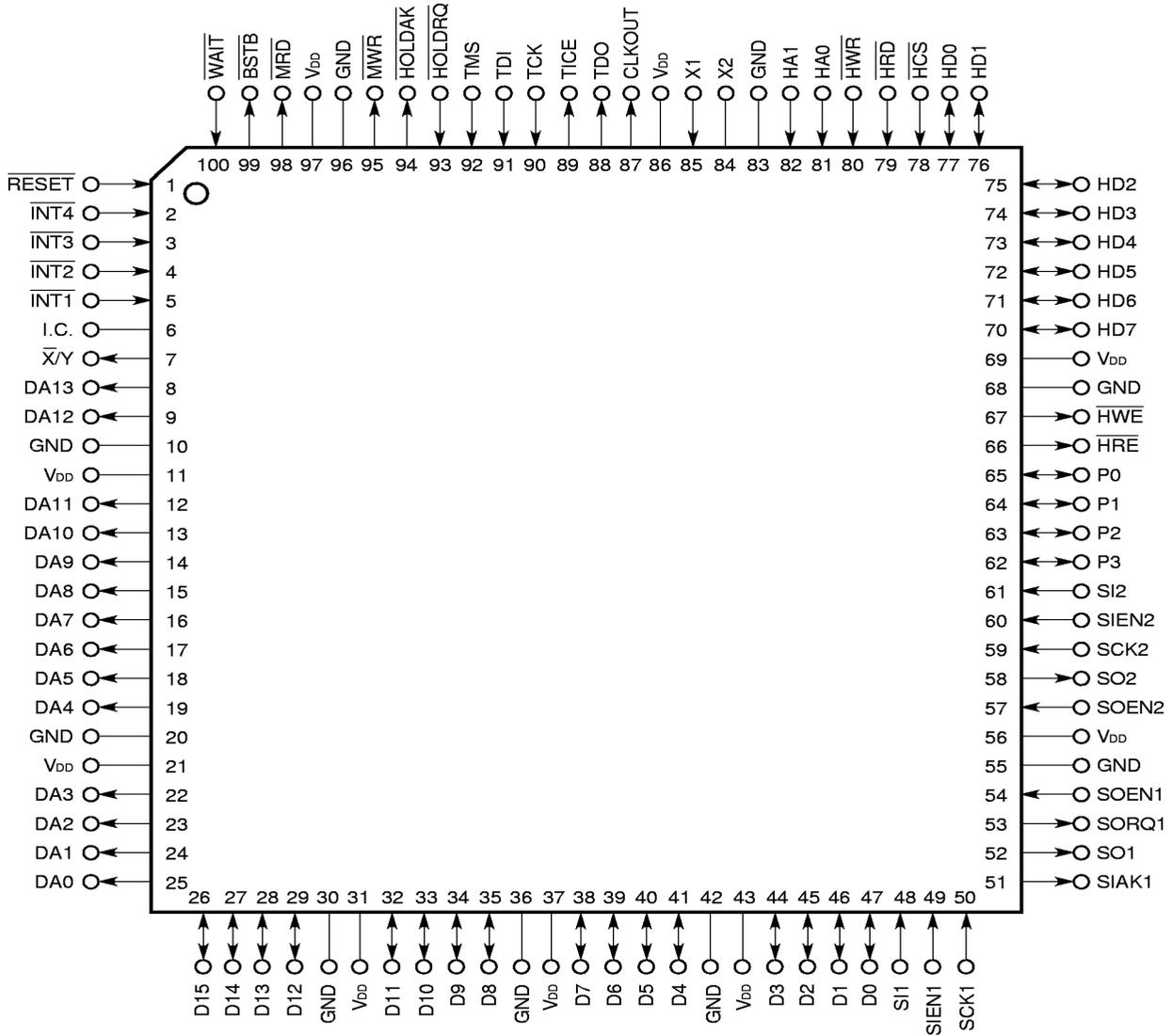

## PIN IDENTIFICATION

$\overline{\text{BSTB}}$ :	Bus Strobe
CLKOUT:	Clock Output
D0-D15:	16 Bits Data Bus
DA0-DA13:	External Data Memory Address Bus
GND:	Ground
HA0,HA1:	Host Data Access
$\overline{\text{HCS}}$ :	Host Chip Select
HD0-HD7:	Host Data Bus
$\overline{\text{HOLDAK}}$ :	Hold Acknowledge
$\overline{\text{HOLDRQ}}$ :	Hold Request
$\overline{\text{HRD}}$ :	Host Read
$\overline{\text{HRE}}$ :	Host Read Enable
$\overline{\text{HWE}}$ :	Host Write Enable
$\overline{\text{HWR}}$ :	Host Write
I.C.:	Internally connection
$\overline{\text{INT1}}-\overline{\text{INT4}}$ :	Interrupt
$\overline{\text{MRD}}$ :	Memory Read Output
$\overline{\text{MWR}}$ :	Memory Write Output
P0-P3:	Port
$\overline{\text{RESET}}$ :	Reset
SCK1,SCK2:	Serial Clock Input
SI1,SI2:	Serial Data Input
SIACK1:	Serial Input Acknowledge
SIEN1,SIEN2:	Serial Input Enable
SO1,SO2:	Serial Data Output
SOEN1,SOEN2:	Serial Output Enable
SORQ1:	Serial Output Request
TCK:	Test Clock Input
TDI:	Test Data Input
TDO:	Test Data Output
TICE:	Test In-Circuit Emulator
TMS:	Test Mode Select
V <sub>DD</sub> :	Power Supply
WAIT:	Wait Input
X1:	Clock input/crystal connection
X2:	Crystal connection
$\overline{\text{X}}/\text{Y}$ :	X/Y Memory Select

**PIN NAME**

Pin No.	Symbol	Pin No.	Symbol	Pin No.	Symbol	Pin No.	Symbol
1	$\overline{\text{RESET}}$	26	D15	51	SIK1	76	HD1
2	$\overline{\text{INT4}}$	27	D14	52	SO1	77	HD0
3	$\overline{\text{INT3}}$	28	D13	53	SORQ1	78	$\overline{\text{HCS}}$
4	$\overline{\text{INT2}}$	29	D12	54	SOEN1	79	$\overline{\text{HRD}}$
5	$\overline{\text{INT1}}$	30	GND	55	GND	80	$\overline{\text{HWR}}$
6	I.C. <b>Note</b>	31	V <sub>DD</sub>	56	V <sub>DD</sub>	81	HA0
7	$\overline{\text{X/Y}}$	32	D11	57	SOEN2	82	HA1
8	DA13	33	D10	58	SO2	83	GND
9	DA12	34	D9	59	SCK2	84	X2
10	GND	35	D8	60	SIEN2	85	X1
11	V <sub>DD</sub>	36	GND	61	SI2	86	V <sub>DD</sub>
12	DA11	37	V <sub>DD</sub>	62	P3	87	CLKOUT
13	DA10	38	D7	63	P2	88	TDO
14	DA9	39	D6	64	P1	89	TICE
15	DA8	40	D5	65	P0	90	TCK
16	DA7	41	D4	66	$\overline{\text{HRE}}$	91	TDI
17	DA6	42	GND	67	$\overline{\text{HWE}}$	92	TMS
18	DA5	43	V <sub>DD</sub>	68	GND	93	$\overline{\text{HOLDRQ}}$
19	DA4	44	D3	69	V <sub>DD</sub>	94	$\overline{\text{HOLDAK}}$
20	GND	45	D2	70	HD7	95	$\overline{\text{MWR}}$
21	V <sub>DD</sub>	46	D1	71	HD6	96	GND
22	DA3	47	D0	72	HD5	97	V <sub>DD</sub>
23	DA2	48	SI1	73	HD4	98	$\overline{\text{MRD}}$
24	DA1	49	SIEN1	74	HD3	99	$\overline{\text{BSTB}}$
25	DA0	50	SCK1	75	HD2	100	$\overline{\text{WAIT}}$

**Note** I.C. (Internally Connected): Leave this pin open.

**CONTENTS**

**1. PIN FUNCTIONS ..... 10**

**1.1 Pin Functions ..... 10**

**1.2 Recommended Connection for Unused Pins ..... 15**

**2. FUNCTIONS ..... 16**

**2.1 Pipeline Processing ..... 16**

        2.1.1 Outline ..... 16

        2.1.2 Instructions with Delay ..... 16

**2.2 Program Control Unit ..... 17**

**2.3 Operation Unit ..... 17**

        2.3.1 General register (R0 to R7) ..... 17

        2.3.2 MAC: Multiply ACcumulator ..... 18

        2.3.3 ALU: Arithmetic Logic Unit ..... 18

        2.3.4 BSFT: Barrel ShiFTer ..... 18

        2.3.5 SAC: Shifter And Count Circuit ..... 18

        2.3.6 CJC: Condition Judge Circuit ..... 19

**2.4 Memory ..... 19**

        2.4.1 Instruction RAM Outline ..... 20

        2.4.2 Data Memory Outline ..... 21

        2.4.3 Data Memory Addressing ..... 22

**2.5 On-chip Peripheral Circuit ..... 22**

        2.5.1 Serial Interface Outline ..... 22

        2.5.2 Host Interface Outline ..... 22

        2.5.3 General Input/output Ports Outline ..... 22

        2.5.4 Wait Cycle Register ..... 22

**3. INSTRUCTIONS ..... 23**

**3.1 Outline ..... 23**

**3.2 Instruction Set and Operation ..... 24**

**4. ELECTRICAL SPECIFICATIONS ..... 32**

**5. PACKAGE DRAWING ..... 53**

**6. RECOMMENDED SOLDERING CONDITIONS ..... 54**

1. PIN FUNCTIONS

1.1 Pin Functions

• Power supply

Symbol	Pin No.	I/O	Function
V <sub>DD</sub>	11, 21, 31, 37, 43, 56, 69, 86, 97	–	+3V power supply
GND	10, 20, 30, 36, 42, 55, 68, 83, 96	–	Ground

• System control

Symbol	Pin No.	I/O	Function
X1	85	I	Clock input / crystal connection pin • The clock signal is connected to X1, when using external clock for system clock.
X2	84	–	Crystal connection pin • X2 should be left open when using external clock for system clock.
CLKOUT	87	O	Internal system clock output
$\overline{\text{RESET}}$	1	I	Internal system reset signal input

• Interrupt

Symbol	Pin No.	I/O	Function
$\overline{\text{INT4}} - \overline{\text{INT1}}$	2 - 5	I	Maskable external interrupt input • Falling edge detection

• External data memory interface

Symbol	Pin No.	I/O	Function
$\overline{X/Y}$	7	O (3S)	Memory select signal output <ul style="list-style-type: none"> <li>• 0: X memory is used.</li> <li>• 1: Y memory is used.</li> </ul>
DA13 - DA0	8, 9, 12 -19, 22 - 25	O (3S)	Address bus to external data memory <ul style="list-style-type: none"> <li>• External data memory is accessed.</li> <li>• During the external memory is not accessed, these pins keep the previous level.</li> </ul> These pins are set to low level; 0000H, by reset. They continue outputting low level until the first external memory access.
D15 - D0	26 -29, 32 - 35, 38 - 41, 44 - 47	I/O (3S)	16 bits data bus to external data memory <ul style="list-style-type: none"> <li>• External data memory is accessed.</li> </ul>
$\overline{MRD}$	98	O (3S)	Read output <ul style="list-style-type: none"> <li>• Reads external memory</li> </ul>
$\overline{MWR}$	95	O (3S)	Write output <ul style="list-style-type: none"> <li>• Writes external memory</li> </ul>
$\overline{WAIT}$	100	I	Wait signal input <ul style="list-style-type: none"> <li>• Wait cycle is input when external memory is read.</li> </ul> 1: No wait 0: Wait
$\overline{HOLDRQ}$	93	I	Hold request signal input <ul style="list-style-type: none"> <li>• Input low level when external data memory bus is expected to use.</li> </ul>
$\overline{BSTB}$	99	O	Bus strobe signal output <ul style="list-style-type: none"> <li>• Outputs low level while the μPD77018A is occupying external memory bus.</li> </ul>
$\overline{HOLDAK}$	94	O	Hold acknowledge signal output <ul style="list-style-type: none"> <li>• Outputs low level when the μPD77018A permits external device to use external data memory bus.</li> </ul>

**Remark** The state of the pins added 3S becomes high impedance when bus release signal ( $\overline{HOLDAK} = 0$ ) is output.

• Serial Interface

Symbol	Pin No.	I/O	Function
SCK1	50	I	Clock input for serial 1
SORQ1	53	O	Serial output 1 request
SOEN1	54	I	Serial output 1 enable
SO1	52	O (3S)	Serial data output 1
SIEN1	49	I	Serial input 1 enable
SI1	48	I	Serial data input 1
SCK2	59	I	Clock input for serial 2
SOEN2	57	I	Serial output 2 enable
SO2	58	O (3S)	Serial data output 2
SIEN2	60	I	Serial input 2 enable
SI2	61	I	Serial data input 2
SIK1	51	O	Serial input 1 acknowledge

**Remark** The state of the pins added 3S becomes high impedance, when data output have been finished or  $\overline{\text{RESET}}$  is input.

• Host interface

Symbol	Pin No.	I/O	Function
HA1	82	I	Specifies register which HD7 to HD0 access 1: Accesses HST: Host interface status register when HA1 = 0 0: Accesses HDT(in): Host transmit data register when $\overline{HWR} = 0$ 0: Accesses HDT(out): Host receive data register when $\overline{HRD} = 0$
HA0	81	I	Specifies bits of registers which HD7 to HD0 access • 1: Accesses bits 15-8 of HST, HDT(in) or HDT(out) • 0: Accesses bits 7-0 of HST, HDT(in) or HDT(out)
$\overline{HCS}$	78	I	Chip select input
$\overline{HRD}$	79	I	Host read input
$\overline{HWR}$	80	I	Host write input
$\overline{HRE}$	66	O	Host read enable output
$\overline{HWE}$	67	O	Host write enable output
HD7 - HD0	70 - 77	I/O (3S)	8 bits host data bus

**Remark** The state of the pins added 3S becomes high impedance when the host does not access host interface.

• I/O port

Symbol	Pin No.	I/O	Function
P3 - P0	62 - 65	I/O	I/O port

• Debugging Interface

Symbol	Pin No.	I/O	Function
TDO	88	O	For debugging
TICE	89	O	For debugging
TCK	90	I	For debugging
TDI	91	I	For debugging
TMS	92	I	For debugging

• Other

Symbol	Pin No.	I/O	Function
I.C.	6	—	Internal connected pin. Leave this pin open. <b>Caution</b> When any signal is applied to or read out from this pin, normal operation of the μPD77018A is not assured.

1.2 Recommended Connection for Unused Pins

Pin	I/O	Recommended connection
$\overline{\text{INT1}} - \overline{\text{INT4}}$	I	connect to V <sub>DD</sub>
$\overline{\text{X}}/\text{Y}$	O	open
DA0 - DA13	O	
D0 - D15 <sup>Note1</sup>	I/O	connect to V <sub>DD</sub> or GND, via a resistor
$\overline{\text{MRD}}$	O	open
$\overline{\text{MWR}}$	O	
$\overline{\text{WAIT}}$	I	connect to V <sub>DD</sub>
$\overline{\text{HOLDRQ}}$	I	
$\overline{\text{BSTB}}$	O	open
$\overline{\text{HOLDAK}}$	O	
SCK1, SCK2	I	connect to V <sub>DD</sub> or GND
SI1, SI2	I	
SOEN1, SOEN2	I	connect to GND
SIEN1, SIEN2	I	
SORQ1	O	open
SO1, SO2	O	
SIK1	O	
HA0, HA1	I	connect to V <sub>DD</sub> or GND
HCS	I	connect to V <sub>DD</sub>
$\overline{\text{HRD}}$	I	
$\overline{\text{HWR}}$	I	
$\overline{\text{HRE}}$	O	open
$\overline{\text{HWE}}$	O	
HD0 - HD7 <sup>Note2</sup>	I/O	connect to V <sub>DD</sub> or GND, via a resistor
P0 - P3	I/O	
TCK	I	connect to GND, via a resistor
TDO, TICE	O	open
TMS, TDI	I	open(pull-up internally)
CLKOUT	O	open

**Notes** 1. Can leave open, if no access to external data memory is executed in the whole of program.

2. Can leave open, if  $\overline{\text{HCS}}$ ,  $\overline{\text{HRD}}$ ,  $\overline{\text{HWR}}$  are fixed to high level.

**Remark** I: Input pin  
 O: Output pin  
 I/O: Input/Output pin

**2. FUNCTIONS**

**2.1 Pipeline Processing**

This section describes the μPD77018A pipeline processing.

**2.1.1 Outline**

The μPD77018A basic operations are executed in following 3-stage pipeline.

- (1) instruction fetch; if
- (2) Instruction decoding; id
- (3) execution; ex

When the μPD77018A operates a result of a instruction just executed before, the data is input to ALU in parallel with written back to general registers. Pipeline processing actualizes programming without delay time to execute instructions and write back data. Three successive instructions and their processing timing are shown below.

**Pipeline Processing Timing**

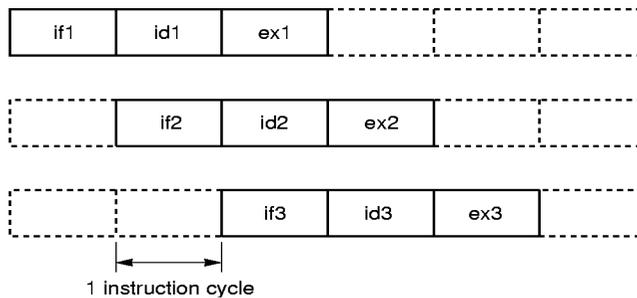

**2.1.2 Instructions with Delay**

The following instructions have delay time in execution.

- (1) Instructions to control interrupt  
2 instruction cycles have been taken between instruction fetch and execution.
- (2) Inter-register transfer instructions and immediate data set instructions  
When data is set in data pointer, it needs 2 instruction cycles before the data is valid.

**2.2 Program Control Unit**

Program control unit controls not only count up of program counter in normal operation, but loop, repeat, branch, halt and interrupt.

In addition to loop stack of loop 4 level and program stack of 15 level, software stack can be used for multi-loop and multi-interrupt/subroutine call.

The μPD77018A has external 4 interruptions and internal 6 interruptions from peripheral, and specifies interrupt enable or disable independently.

The HALT and STOP instructions cause the μPD77018A to place in low power standby mode.

When the HALT instruction is executed, power consumption decreases. HALT mode is released by interrupt input or hardware reset input. It takes several system clock to recover.

When the STOP instruction is executed, power consumption decreases. STOP mode is released by hardware reset input. It takes a few ms to recover.

**2.3 Operation Unit**

Operation unit consists of the following five parts.

- 40 bits general register × 8 for data load/store and input/output of operation data
- 16 bits × 16 bits + 40 bits → 40 bits multiply accumulator
- 40 bits Data ALU
- 40 bits barrel shifter
- SAC: shifter and count circuit.

Standard word length is 40 bits to make overflow check and adjustment easy, and to accumulate the result of 16 bits × 16 bits multiplication correctly.

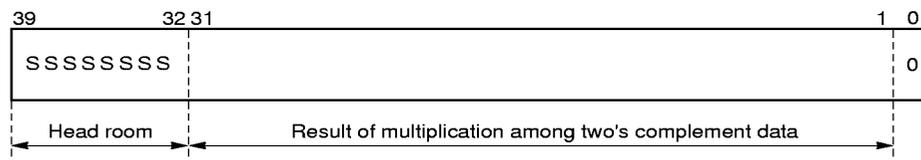

**2.3.1 General register (R0 to R7)**

The μPD77018A has eight 40 bits registers for operation input/output and load/store with memory. General register consists of the following three parts.

- R0L to R7L (bit 15 to bit 0)
- R0H to R7H (bit 31 to bit 16)
- R0E to R7E (bit 39 to bit 32)

But each of RnL, RnH and RnE are treated as a register in the following conditions.

**(1) General register used as 40 bits register**

General registers are treated as 40 bits register, when they are used for the following aims.

- (a) Operand for triminal operation (except for multiplier input)
- (b) Operand for dyadic operation (except for multiplier and shift value)
- (c) Operand for monadic operation (except for exponent instructions)
- (d) Operand for operation
- (e) Operand for conditional judge
- (f) Destination for load instruction (with sign extension and 0 clear)

**(2) General register used as 32 bits register**

Bit 31 to bit 0 of general register are treated as 32 bits register, when it is used for a operand of exponent instruction.

**(3) General register used as 24 bits register**

Bit 39 to bit 16 of general register are treated as 24 bits register, when it is used for destination with extended sign for a load/store instruction.

**(4) General register used as 16 bits register**

Bit 31 to bit 16 of general register are treated as 16 bits register, when it is used for the following aims.

- (a) Signed operand for multiplier
- (b) Source/destination for load/store instruction

Bit 15 to bit 0 of general register are treated as 16 bits register, when it is used for the following aims.

- (c) Unsigned operand for multiplier
- (d) Shift value for shift instruction
- (e) Source/destination for load/store instruction
- (f) Source/destination for inter-register transfer instruction
- (g) Destination for immediate data set instruction
- (f) Hardware loop times

**(5) General register used as 8 bits register**

Bit 39 to bit 32 of general register are treated as 8 bits register, when it is used for source/destination of load/store instruction.

**2.3.2 MAC: Multiply ACcumulator**

MAC multiplies a pair of 16 bits data, and adds or subtract the result and 40 bits data. MAC outputs 40 bits data.

MAC operates three types of multiplication: signed data  $\times$  signed data, signed data  $\times$  unsigned data and unsigned data  $\times$  unsigned data.

Result of multiplication and 40 bits data for addition can be added after 1 or 16 bits arithmetic shift right.

**2.3.3 ALU: Arithmetic Logic Unit**

ALU performs arithmetic operation and logic operation. Both input/output data are 40 bits.

**2.3.4 BSFT: Barrel SHIFTer**

BSFT performs shift right/left operation. Both input/output data are 40 bits. There are two types of shift right operations; arithmetic shift right which sign is extended, and logic shift right which is input 0 in MSB first.

**2.3.5 SAC: Shifter And Count Circuit**

SAC calculates and outputs shift value for normalization. SAC is input 32 bits data and outputs the 40 bits data. Then, bit 39 to bit 5 of output data is always 0.

### 2.3.6 CJC: Condition Judge Circuit

CJC judges whether condition is true or false with 40 bits input data. A conditional instruction is executed when the result is true, and not executed when the result is false.

## 2.4 Memory

The  $\mu$ PD77018A has one instruction memory area (64K words  $\times$  32 bits) and two data memory areas (64K words  $\times$  16 bits each). It adopts Harvard-type architecture, with instruction memory area and data memory areas separated.

The  $\mu$ PD77018A has 2 sets of data addressing units, which are dedicated for addressing data memory area. Each addressing unit consists of four data pointers, four index registers, a modulo register and addressing ALU.

X memory area addresses are specified by DP0 to DP3, and Y memory area addresses are specified by DP4 to DP7. After memory access, DPn (with the same subscript), can be modified by DNn value. Modulo operation is performed with DMX for DP0 to DP3, with DMY for DP4 to DP7.

**2.4.1 Instruction RAM Outline**

The μPD77018A has an instruction ROM (24K words × 32 bits) and instruction RAM (256 words × 32 bits).

The μPD77019 has an instruction ROM (24K words × 32 bits) and instruction RAM (4K words × 32 bits).

A system vector area is assigned to 64 words of the instruction RAM. Internal instruction RAM is initialized and rewritten by boot program.

Boot up ROM contains the program loading instruction code to internal instruction RAM.

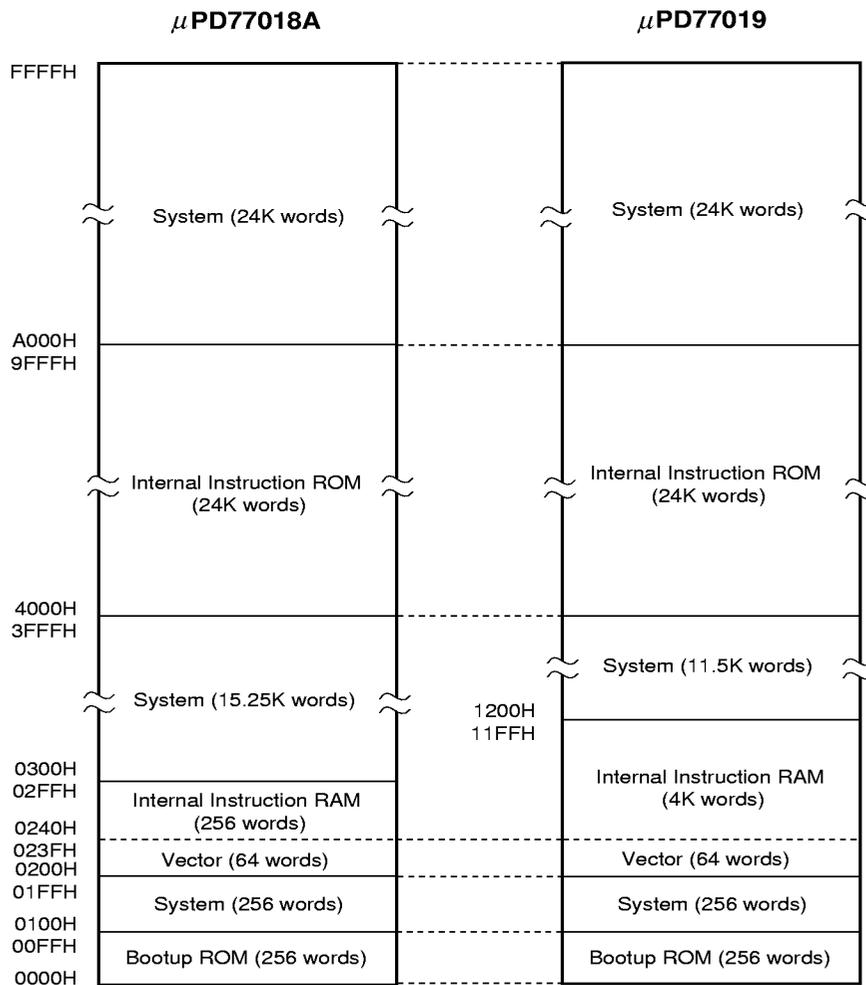

**Caution** When any data is accessed or stored to system address, normal operation of the device is not assured.

**2.4.2 Data Memory Outline**

The μPD77018A and the μPD77019 each has two data memory areas (64K words × 16 bits each) in X and Y memory areas.

Every memory areas consists of 3K words × 16 bits data RAM and 12K words × 16 bits data ROM . As the μPD77018A and the μPD77019 each has interface with the external data memory, 16 K words × 16 bits external data memory space can be added to X/Y memories.

Each data memory area includes on-chip peripheral area which consists of 64 words.

When the external data memory area is accessed, instruction cycle can be 2 or more by wait function.

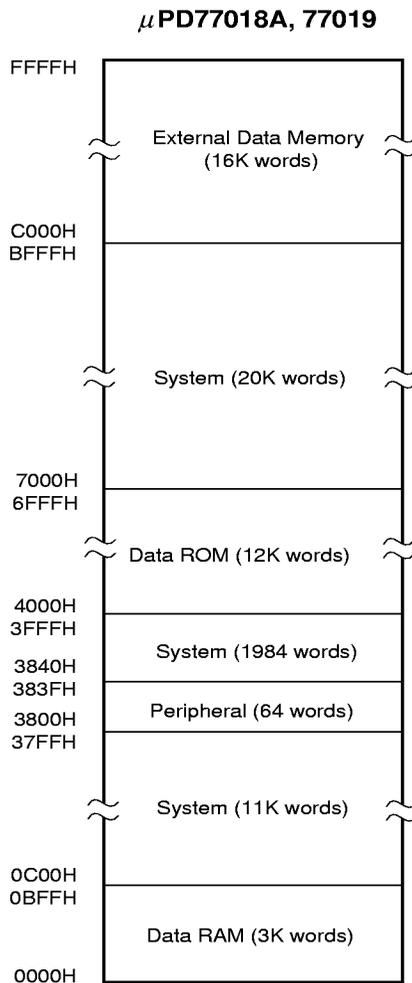

**Caution** When any data is accessed or stored to system address, normal operation of the device is not assured.

### 2.4.3 Data Memory Addressing

There are following two types of data memory addressing.

- Direct addressing

The address is specified in the instruction field.

- Indirect addressing

The address is specified by the data pointer (DP). DP can get a bit reverse before addressing. It can update the DP value after accessing data memory.

## 2.5 On-chip Peripheral Circuit

The  $\mu$ PD77018A includes serial interface, host interface, general input/output ports and wait cycle registers. They are mapped in both X and Y memory areas, and are accessed as memory mapped I/O by the  $\mu$ PD77018A CPU.

### 2.5.1 Serial Interface Outline

The  $\mu$ PD77018A has 2 channel serial interfaces. Serial I/O clock must be provided from external. Frame length can be programmed independently to be 8 bits or 16 bits. MSB first or LSB first can also be selected. Data is input/output by hand shaking for an external device, and by interrupts, polling or wait function in internal.

### 2.5.2 Host Interface Outline

The  $\mu$ PD77018A has 8 bits parallel ports as host interface to input/output data to and from host CPU and DMA controller. When an external device accesses host interface, HA0 and HA1 pins; which are host address input pins; specifies bit 15 to bit 8 and bit 7 to bit 0. The  $\mu$ PD77018A includes 3 registers consisting of 16 bits, which are dedicated for input data, output data and status. The  $\mu$ PD77018A has three types of interface method for internal and external data; interrupts, polling and wait function.

### 2.5.3 General Input/output Ports Outline

General input/output ports consist of 4 bits. User can set each port as input or output. The  $\mu$ PD77018A includes two registers. One is 4 bits register for input/output data, and the other is 16 bits for control.

### 2.5.4 Wait Cycle Register

The wait cycle registers consist of 16 bits. It is used to set wait cycle number when external memory is accessed. When external data memory area (C000H - FFFFH) is accessed, 0, 1, 3, or 7 wait cycle can be set.

When external data memory area is accessed, wait cycle can be also set by WAIT pin.

### 3. INSTRUCTIONS

#### 3.1 Outline

All  $\mu$ PD77018A instructions are one-word instructions, consisting of 32 bits. And they are executed in 16.6 ns (min.) per instruction. There are following 9 instruction types.

**(1) Trinomial instructions**

: specify the Acc operation. 3 of general registers are specified optionally as the operation object.

**(2) Dyadic operation instructions**

: specify the Acc, ALU or shifter operation. 2 of general registers are specified optionally as the operation object. Some instructions can specify a general register and immediate data.

**(3) Monadic operation instructions**

: specify operations by ALU. 1 general register is specified optionally as the operation object.

**(4) Load/store instructions**

: transfer 16 bits data from memory to general registers, from general registers to memory and between general registers.

**(5) Inter-register transfer instructions**

: transfer data between general register and other registers.

**(6) Immediate data set instructions**

: set immediate data at general registers or each registers of address operation unit.

**(7) Branch instructions**

: specify the direction of the program flow.

**(8) Hardware loop instructions**

: specify times of instruction repeating.

**(9) Control Instructions**

: specify the control program.

**3.2 Instruction Set and Operation**

An operation is written according to the rules for expressing. An expression of instructions having two or more descriptions can have only one selected.

**(a) Expressions and selectable registers**

Expression and selectable registers are shown as follows.

Expression	Selectable registers
ro, ro', ro"	R0 - R7
rl, rl'	R0L - R7L
rh, rh'	R0H - R7H
re	R0E - R7E
reh	R0EH - R7EH
dp	DP0 - DP7
dn	DN0 - DN7
dm	DMX, DMY
dpx	DP0 - DP3
dpy	DP4 - DP7
dpx_mod	DPn, DPn++, DPn--, DPn##, DPn%%, !DPn## (n = 0 - 3)
dpy_mod	DPn, DPn++, DPn--, DPn##, DPn%%, !DPn## (n = 4 - 7)
dp_imm	DPn##imm (n = 0 - 7)
*xxx	content of memory address xxx <b>Example</b> When the content of DP0 register is 1000, *DP0 shows the content of memory address 1000.

**(b) Modifying data pointers**

Data pointers are modified after memory access. The results are valid immediately after instruction execution. It is impossible to modify without memory access.

Description	Operation
DPn	No operation: DPn value does not change.
DPn++	$DPn \leftarrow DPn+1$
DPn--	$DPn \leftarrow DPn-1$
DPn##	DPn ← DPn + DNn: Adds DN0-DN7 corresponding to DP0-DP7 <b>Example</b> DP0 ← DP0 + DN0
DPn%%	(n = 0 - 3) $DPn = ((DP_L + DNn) \bmod (DMX + 1)) + DP_H$
	(n = 4 - 7) $DPn = ((DP_L + DNn) \bmod (DMY + 1)) + DP_H$
!DPn##	Access memory after DPn value is bit-reversed After memory access, $DPn \leftarrow DPn + DNn$
DPn##imm	$DPn \leftarrow DPn + imm$

**(c) Concurrent processing instructions**

○ shows concurrent processing instruction.

Instruction names are shown in abbreviation.

- TRI : Trinomial
- DYAD : Dyadic
- MONAD : Monadic
- TRANS : Inter-register transfer
- IMM : Immediate data set
- BR : Branch
- LOOP : Hardware loop
- CTR : Control

**(d) State of Overflow flag (OV)**

The following marks show the μPD77018A overflow flag state.

- : Not affected
- ↑ : 1 is set when the result of operation is overflow.

**Caution** If overflow does not occur after operation, OV is not reset, and keeps the state before operation.

μPD77018A INSTRUCTION SET

Name	Mnemonic	Operation	Concurrent Writing Processing							Flag			
			TRI.	DYAD.	MONAD.	Load/store	TRANS.	IMM.	BR.		LOOP.	CTL.	OV.
Trinomial	Multiply add	$ro = ro + r1 * r1'$				○							↕
	Multiply sub	$ro = ro - r1 * r1'$				○							↕
	Sign unsign Multiply add	$ro = ro + r1 * r1'$ (r1 should be a plus integral number.)				○							↕
	Unsign Multiply add	$ro = ro + r1 * r1'$ (r1 and r1' should be a plus integral number.)				○							↕
	1 bit shift Multiply add	$ro = (ro >> 1) + r1 * r1'$				○							↕
	16 bits shift Multiply add	$ro = (ro >> 16) + r1 * r1'$				○							●
	Multiply	$ro = r1 * r1'$				○							●
	Add	$ro'' = ro + ro'$				○							↕
	Immediate add	$ro' = ro + imm$											↕
	Sub	$ro'' = ro - ro'$				○							↕
Immediate sub	$ro' = ro - imm$											↕	
Arithmetic right shift	$ro' = ro \text{ SRA } r1$				○							●	
Immediate arithmetic right shift	$ro' = ro \text{ SRA } imm$											●	
Logic right shift	$ro' = ro \text{ SRL } r1$						○					●	
Immediate Logic right shift	$ro' = ro \text{ SRL } imm$											●	
Logic left shift	$ro' = ro \text{ SLL } r1$						○					●	
Immediate logic left shift	$ro' = ro \text{ SLL } imm$											●	

	Name	Mnemonic	Operation	Concurrent Writing Processing							Flag			
				TRI.	DYAD.	MONAD.	Load/store	TRANS.	IMM.	BR. LOOP.		CTL.	OV.	
Dyadic	And	$ro'' = ro \& ro'$	$ro'' \leftarrow ro \& ro'$				<input type="radio"/>						●	
	Immediate and	$ro' = ro \& imm$	$ro' \leftarrow ro \& imm$										●	
	Or	$ro'' = ro   ro'$	$ro'' \leftarrow ro   ro'$				<input type="radio"/>						●	
	Immediate or	$ro' = ro   imm$	$ro' \leftarrow ro   imm$										●	
	Exclusive or	$ro'' = ro \wedge ro'$	$ro'' \leftarrow ro \wedge ro'$				<input type="radio"/>						●	
	Immediate exclusive or	$ro = ro \wedge imm$	$ro \leftarrow ro \wedge imm$										●	
	Less than	$ro'' = LT(ro, ro')$	if(ro<ro') {ro'' ← 0000000001H} else {ro'' ← 0000000000H}				<input type="radio"/>						●	
	Clear	CLR(ro)	$ro \leftarrow 0H$				<input type="radio"/>						○	●
	Increment	$ro' = ro + 1$	$ro' \leftarrow ro + 1$				<input type="radio"/>						○	↔
	Decrement	$ro' = ro - 1$	$ro' \leftarrow ro - 1$				<input type="radio"/>						○	↔
Monadic	Absolute	$ro' = ABS(ro)$	if (ro<0) {ro' ← -ro} else {ro' ← ro}				<input type="radio"/>						○	↔
	One's complement	$ro' = \sim ro$	$ro' \leftarrow \sim ro$				<input type="radio"/>						○	●
	Two's complement	$ro' = -ro$	$ro' \leftarrow -ro$				<input type="radio"/>						○	↔
	Clip	$ro' = CLIP(ro)$	if (ro>007FFFFFFFH) {ro' ← 007FFFFFFFH} else if, (ro<FF80000000H) {ro' ← FF80000000H} else {ro' ← ro}				<input type="radio"/>						○	↔
	Round	$ro' = ROUND(ro)$	if (ro>007FFF0000H) {ro' ← 007FFF0000H} else if, (ro>FF80000000H) {ro' ← FF80000000H} else {ro' ← (ro + 8000H) & FFFFFFFF0000H}				<input type="radio"/>						○	↔
	Exponent	$ro' = EXP(ro)$	$ro' \leftarrow \log_2 \left( \frac{1}{ro} \right)$				<input type="radio"/>						○	●
	Substitution	$ro' = ro$	$ro' \leftarrow ro$				<input type="radio"/>						○	●

	Name	Mnemonic	Operation	Concurrent Writing Processing							Flag		
				TRI.	DYAD.	MONAD.	Load/ store	TRANS.	IMM.	BR. LOOP.		CTL.	OV
Monadic	Cumulation	ro+ = ro	ro' ← ro+ro				○					↕	
	Degression	ro- = ro	ro' ← ro-ro				○					↕	
	Division	ro/ = ro	if (sign(ro)≠sign(ro)) {ro' ← (ro-ro)<<1} else {ro' ← (ro+ro)< if (sign(ro)≠0 {ro' ← ro+1}				○					↕	
Load/store	Parallel load/store <b>Note 1, Note 2</b>	ro=*dpx_mod ro'=*dpy_mod	ro ← *dpx, ro' ← *dpy									●	
		ro=*dpx_mod *dpy_mod=rh	ro ← *dpx, *dpy ← rh	○									
		*dpx_mod=rh ro=*dpy_mod	*dpx ← rh, ro ← *dpy										
		*dpx_mod=rh *dpy_mod=rh'	*dpx ← rh, *dpy ← rh'										
Section load/store <b>Note 1, Note 2, Note 3</b>	dest=*dpx_mod dest'=*dpy_mod	dest=*dpx_mod dest' ← *dpy											
	dest=*dpx_mod *dpy_mod=source	dest ← *dpx, *dpy ← source											
	*dpx_mod=source dest=*dpy_mod	*dpx ← source, dest ← *dpy											
		*dpx_mod=source *dpy_mod=source'	*dpx ← source, *dpy ← source'										

- Notes**
1. One or both of a mnemonic pair can be written.
  2. After execution of load/store, data is modified by mod.
  3. One of following mnemonic should be selected: dest, dest' = {ro, reh, re, rh, rl}, source, source' = {re, rh, rl}.



	Name	Mnemonic	Operation	Concurrent Writing Processing							Flag			
				TRI.	DYAD.	MONAD.	Load/store	TRANS.	IMM.	BR.	LOOP.	CTL.	OV	
Branch	Jump	JMP imm	PC ← imm										●	○
	Inter-register indirect jump	JMP dp	PC ← dp										●	○
	Subroutine call	CALL imm	SP ← SP + 1 STK ← PC + 1 PC ← imm										●	○
	Inter-register indirect subroutine call	CALL dp	SP ← SP + 1 STK ← PC + 1 PC ← dp										●	○
	Return	RET	PC ← STK SP ← SP - 1										●	○
Hardware loop	Return from interrupt	RETI	PC ← STK STK ← SP - 1 Restore the interrupt enable flag										●	○
	Repeat	REP count	start RC ← count RF ← 0 PC ← PC repeat RC ← RC - 1 end PC ← PC + 1 RF ← 1										●	
	Loop	LOOP count (Mnemonics more than two lines)	start RC ← count RF ← 0 PC ← PC repeat RC ← RC - 1 end PC ← PC + 1 RF ← 1										●	
Control	Loop pop	LPOP	LC ← LSR3 LE ← LSR2 LS ← LSR1 LSP ← LSP - 1										●	
	No operation	NOP	PC ← PC + 1										●	
	Halt	HALT	CPU stop <b>Note1</b>										●	
	Stop	STOP	CPU, PLL, OSC Stop <b>Note2</b>										●	
	If (ro cond)	IF (ro cond)	Conditional judge									○	○	●
	Forget interrupt	FINT	Forget interrupt requests										○	●

- Notes**
1. The HALT instruction causes all function except for clock and PLL to halt. The system is placed in much less power consumption mode.  
The contents of internal registers and memories are maintained.  
HALT is released by interrupt input. It takes several system clock to recover.
  2. The STOP instruction causes all function including clock and PLL to stop. The system is placed in a minimum-power consumption mode.  
The contents of internal registers and memories are not maintained.  
After the STOP instruction is executed, pin status is maintained.  
STOP is released by hardware reset. It takes a few ms to recover.

4. ELECTRICAL SPECIFICATIONS

**Absolute Maximum Ratings (T<sub>A</sub> = +25 °C)**

Parameters	Symbol	Conditions	Ratings	Unit
Power supply voltage	V <sub>DD</sub>		-0.5 to +4.6	V
Input voltage	V <sub>I</sub>	2.7 V ≤ V <sub>DD</sub> ≤ 3.6 V	-0.5 to +4.1 V <sub>I</sub> < V <sub>DD</sub> +0.5 V	V
Output voltage	V <sub>O</sub>		-0.5 to +4.6	V
Storage temperature	T <sub>stg</sub>		-65 to +150	°C
Operating ambient temperature	T <sub>A</sub>		-40 to +85	°C

**Caution** Exposure to Absolute Maximum Ratings for extended periods may affect device reliability; exceeding the ratings could cause permanent damage. The parameters apply independently. The device should be operated within the limits specified under DC and AC Characteristics.

★ **Recommended Operating Conditions**

Parameters	Symbol	Conditions	MIN.	TYP.	MAX.	Unit	
Operating voltage	V <sub>DD</sub>	μPD77018A	t <sub>ec</sub> ≥ 19.0 ns	2.7	3.0	3.6	V
			t <sub>ec</sub> ≥ 16.6 ns	3.0	3.3	3.6	V
		μPD77019	t <sub>ec</sub> ≥ 20.0 ns	2.7	3.0	3.6	V
			t <sub>ec</sub> ≥ 16.6 ns	3.0	3.3	3.6	V
Input voltage	V <sub>I</sub>		0		V <sub>DD</sub>	V	

**Capacitance (T<sub>A</sub> = +25 °C, V<sub>DD</sub> = 0 V)**

Parameters	Symbol	Conditions	MIN.	TYP.	MAX.	Unit
Input capacitance	C <sub>I</sub>	f = 1 MHz Unmeasured pins returned to 0 V.		10		pF
Output capacitance	C <sub>O</sub>			10		pF
Input/output capacitance	C <sub>IO</sub>			10		pF

DC Characteristics (T<sub>A</sub> = -40 to +85 °C, V<sub>DD</sub> = 2.7 to 3.6 V)

Parameters	Symbol	Conditions	MIN.	TYP.	MAX.	Unit	
High level input voltage	V <sub>IH</sub>	Except for X1	0.7V <sub>DD</sub>		V <sub>DD</sub>	V	
High level X1 input voltage	V <sub>IHC</sub>	X1 input	0.8V <sub>DD</sub>		V <sub>DD</sub>	V	
Low level input voltage	V <sub>IL</sub>		0		0.2V <sub>DD</sub>	V	
High level output voltage	V <sub>OH</sub>	I <sub>OH</sub> = -2.0 mA	0.7V <sub>DD</sub>			V	
		I <sub>OH</sub> = -100 μA	0.8V <sub>DD</sub>			V	
Low level output voltage	V <sub>OL</sub>	I <sub>OL</sub> = 2.0 mA			0.2V <sub>DD</sub>	V	
High level input leak current	I <sub>LIH</sub>	Except for TDI, TMS, V <sub>i</sub> = V <sub>DD</sub>			10	μA	
Low level input leak current	I <sub>LIL</sub>	Except for TDI, TMS, V <sub>i</sub> = 0 V			-10	μA	
Pull-up pin current	I <sub>PI</sub>	TDI, TMS, 0 V ≤ V <sub>i</sub> ≤ V <sub>DD</sub>			-250	μA	
Power supply current	I <sub>DD</sub>	μPD77018A	Active mode, t <sub>c</sub> = 25 ns, V <sub>IH</sub> = V <sub>DD</sub> , V <sub>IL</sub> = 0 V, no load		TBD	125 <sup>Note 1</sup>	mA
		μPD77019	Active mode, t <sub>c</sub> = 25 ns, V <sub>IH</sub> = V <sub>DD</sub> , V <sub>IL</sub> = 0 V, no load		TBD	150 <sup>Note 1</sup>	mA
	I <sub>DDH</sub>	μPD77018A	HALT mode, t <sub>c</sub> = 200 ns, V <sub>IH</sub> = V <sub>DD</sub> , V <sub>IL</sub> = 0 V, no load			13.5 <sup>Note 2</sup>	mA
		μPD77019	HALT mode, t <sub>c</sub> = 200 ns, V <sub>IH</sub> = V <sub>DD</sub> , V <sub>IL</sub> = 0 V, no load			15 <sup>Note 2</sup>	mA
	I <sub>DDs</sub>	STOP mode, T <sub>A</sub> = +60 °C, V <sub>H</sub> = V <sub>DD</sub> , V <sub>IL</sub> = 0 V, no load			100	μA	

**Notes 1.** The MAX. value is measured when a special program that MAX. switching required is executed, and V<sub>DD</sub> = 3.6 V condition.

You can convert by each operation frequency f [MHz] on by each power supply V<sub>DD</sub> [V].

[μPD77018A] Max. current value (T<sub>A</sub> = +25 °C) = (1.15 × V<sub>DD</sub> - 1.21) × f + 8 [mA]

[μPD77019] Max. current value (T<sub>A</sub> = +25 °C) = (1.40 × V<sub>DD</sub> - 1.74) × f + 18 [mA]

**2.** This value is measured when V<sub>DD</sub> = 3.6 V condition.

You can convert by each operation frequency f [MHz] on by each power supply V<sub>DD</sub> [V].

[μPD77018A] HALT current value (T<sub>A</sub> = +25 °C) = (0.15 × V<sub>DD</sub> - 0.25) × f + 2 [mA]

[μPD77019] HALT current value (T<sub>A</sub> = +25 °C) = (0.17 × V<sub>DD</sub> - 0.38) × f + 5.9 [mA]

AC Timing Test Points

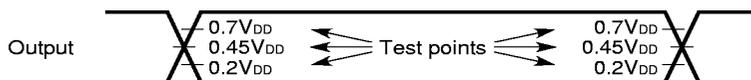
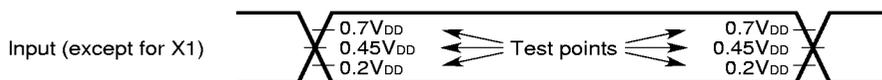
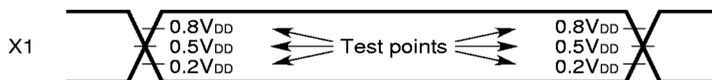

AC Characteristics (T<sub>A</sub> = -40 to +85 °C, V<sub>DD</sub> = 2.7 to 3.6 V)

**Clock**

★ Required Timing Condition (V<sub>DD</sub> = 2.7 V to 3.6 V)

Parameters	Symbol	Conditions	MIN.	TYP.	MAX.	Unit	
CLKIN cycle time	t <sub>ccx</sub>	μPD77018A	PLL multiple rate: 1	19		40	ns
			PLL multiple rate: 2	38		80	ns
			PLL multiple rate: 3	57		120	ns
			PLL multiple rate: 4	76		160	ns
			PLL multiple rate: 8	152		320	ns
		μPD77019	PLL multiple rate: 1	20		40	ns
			PLL multiple rate: 2	40		80	ns
			PLL multiple rate: 3	60		120	ns
			PLL multiple rate: 4	80		160	ns
			PLL multiple rate: 8	160		320	ns
CLKIN high level width	t <sub>wcXH</sub>		8		t <sub>ccx</sub> - 8 - 2t <sub>ricx</sub> Note	ns	
CLKIN low level width	t <sub>wcXL</sub>		8		t <sub>ccx</sub> - 8 - 2t <sub>ricx</sub> Note	ns	
CLKIN rise/fall time	t <sub>ricx</sub>				15	ns	

Note 0.5t<sub>ccx</sub> - t<sub>ricx</sub> ≥ 8 (MIN.)

★ Required Timing Condition (V<sub>DD</sub> = 3.0 V to 3.6 V)

Parameters	Symbol	Conditions	MIN.	TYP.	MAX.	Unit
CLKIN cycle time	t <sub>ccx</sub>	PLL multiple rate: 1	16.6		40	ns
		PLL multiple rate: 2	33.3		80	ns
		PLL multiple rate: 3	50		120	ns
		PLL multiple rate: 4	66.6		160	ns
		PLL multiple rate: 8	133		320	ns
CLKIN high level width	t <sub>wcXH</sub>		6.5		t <sub>ccx</sub> - 6.5 - 2t <sub>ricx</sub> Note	ns
CLKIN low level width	t <sub>wcXL</sub>		6.5		t <sub>ccx</sub> - 6.5 - 2t <sub>ricx</sub> Note	ns
CLKIN rise/fall time	t <sub>ricx</sub>				15	ns

Note 0.5t<sub>ccx</sub> - t<sub>ricx</sub> ≥ 6.5 (MIN.)

**Switching Characteristics**

Parameters	Symbol	Conditions	MIN.	TYP.	MAX.	Unit
Internal clock cycle time	t <sub>cc</sub>	Active mode		t <sub>ccx</sub> /NNote		ns
		HALT mode		8t <sub>ccx</sub> /NNote		ns
CLKOUT cycle time	t <sub>cco</sub>			t <sub>cc</sub>		ns
CLKOUT level width	t <sub>wco</sub>		0.5t <sub>cco</sub> - 5			ns
CLKOUT rise/fall time	t <sub>rico</sub>				5	ns

Note N: PLL multiple rate (N = 1, 2, 3, 4, 8)

★ **Oscillator Circuit**

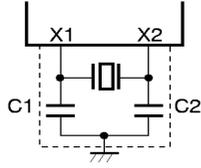
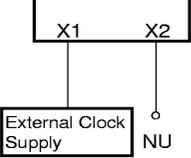
Resonator	Recommended Circuit
Ceramic or crystal resonator	
External clock	 <p data-bbox="927 716 1193 737">NU: Not Use. Leave Open.</p>

**Cautions 1. When using system clock oscillator, wire the portion enclosed in broken lines in the figure as follows to avoid adverse influences on the wiring capacitance:**

- **Keep the wiring length as short as possible.**
- **Do not cross the wiring over the other signal lines.**
- **Do not route the wiring in the vicinity of lines through which a high fluctuating current flows.**
- **Always keep the ground point of the capacitor of the oscillator circuit at the same potential as GND.**
- **Do not connect the power source pattern through which a high current flows.**
- **Do not extract signals from the oscillator.**

**2. When using ceramic resonator or crystal resonator, frequency multiple rate should be specified to as 1 by mask option. The device does not operate in other frequency multiple rate.**

★ **Recommended Oscillator Circuit Constants**

TBD

**Reset, Interrupt**

**Required Timing Condition**

Parameters	Symbol	Conditions	MIN.	TYP.	MAX.	Unit
$\overline{\text{RESET}}$ low level width	$t_{w(RL)}$	Crystal resonator is input, at power on or STOP mode	3 <sup>Note 1</sup>			ms
		External clock is input, at power on or STOP mode	100 <sup>Note 1</sup>			μs
		Active mode or HALT mode	4 $t_{cC}$ <sup>Note 2</sup>			ns
$\overline{\text{RESET}}$ recovery time	$t_{rec(R)}$		4 $t_{cC}$			ns
$\overline{\text{INT1}}\text{-}\overline{\text{INT4}}$ low level width	$t_{w(INTL)}$		3 $t_{cC}$ <sup>Note 2</sup>			ns
$\overline{\text{INT1}}\text{-}\overline{\text{INT4}}$ recovery time	$t_{rec(INT)}$		3 $t_{cC}$			ns

- Notes 1.** The  $t_{w(RL)}$  indicates a time between crystal resonator or oscillator starts to provide clock and PLL becomes stable. The  $t_{w(RL)}$  depends on the rating of crystal resonator or oscillator. At power on, the  $t_{w(RL)}$  is measured after the point that power supply voltage reaches to 2.7V.
- 2.** Note that, during HALT mode,  $t_{cC}$  is extended to 8 times as long as that of Active mode.

**Clock Input/Output Timing**

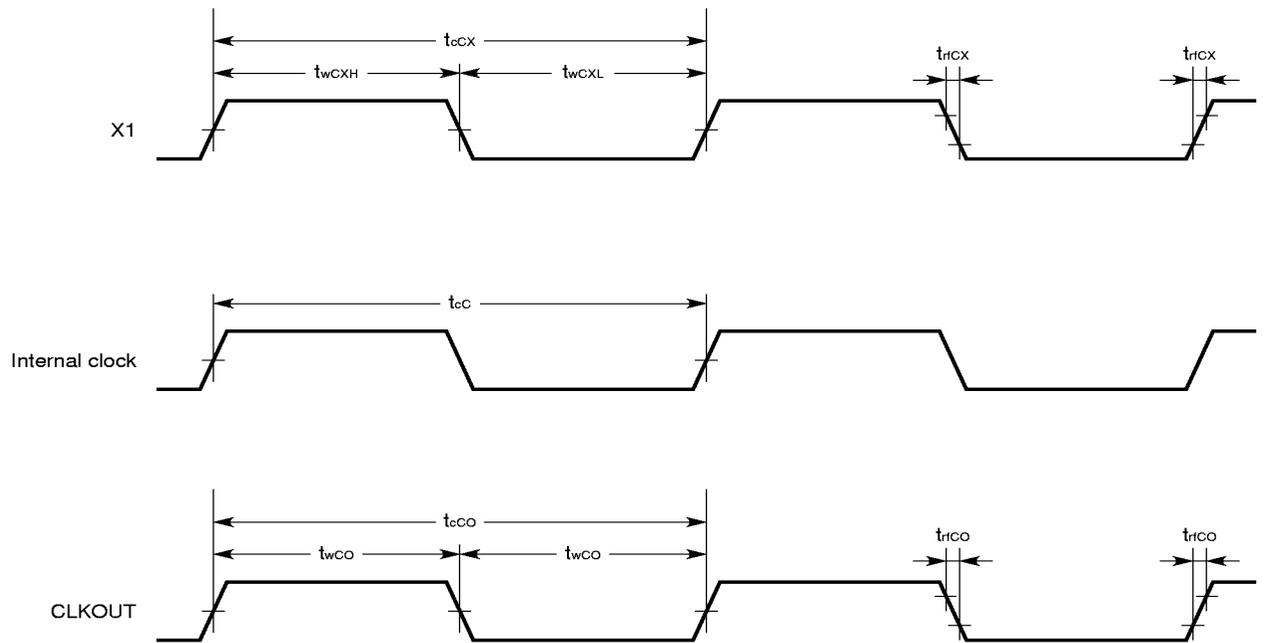

**Reset Timing**

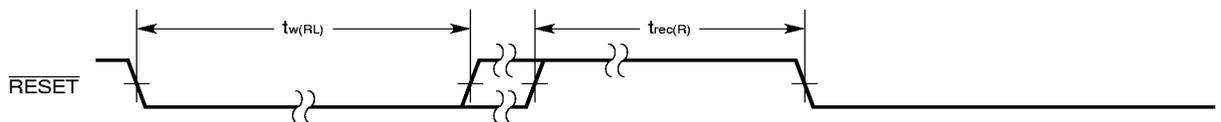

**Interrupt Timing**

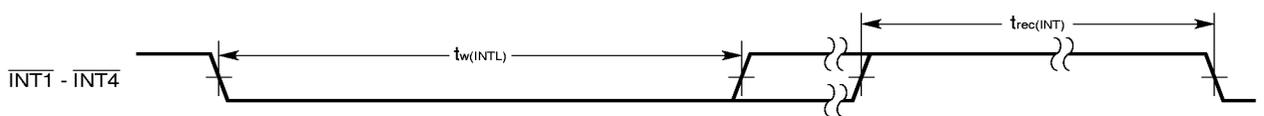

External Data Memory Access

Required Timing Condition

Parameters	Symbol	Conditions	MIN.	TYP.	MAX.	Unit
Read data setup time	$t_{suDDRd}$		15			ns
Read data hold time	$t_{hDDRd}$		0			ns
$\overline{WAIT}$ setup time	$t_{suWA}$		12			ns
$\overline{WAIT}$ hold time	$t_{hWA}$		0			ns

Switching Characteristics

Parameters	Symbol	Conditions	MIN.	TYP.	MAX.	Unit
Address output delay time	$t_{dDA}$				8	ns
Address output hold time	$t_{hDA}$		0			ns
$\overline{MRD}$ output delay time	$t_{dDR}$				8	ns
$\overline{MRD}$ hold time	$t_{hDR}$		0			ns
Write data output valid time	$t_{vDDWD}$				16	ns
Write data output hold time	$t_{hDDWD}$		0			ns
$\overline{MWR}$ output delay time	$t_{dDW}$		$0.25t_{cC} - 5$			ns
$\overline{MWR}$ setup time	$t_{suDW}$		0			ns
$\overline{MWR}$ low level width	$t_{wDWL}$		$0.5t_{cC} - 3$ + $t_{cDW}$ <b>Note</b>			ns
$\overline{MWR}$ high level width	$t_{wDWH}$		$0.5t_{cC} - 5$			ns

**Note**  $t_{cDW}$ : Data wait cycle

External Data Memory Access Timing (Read)

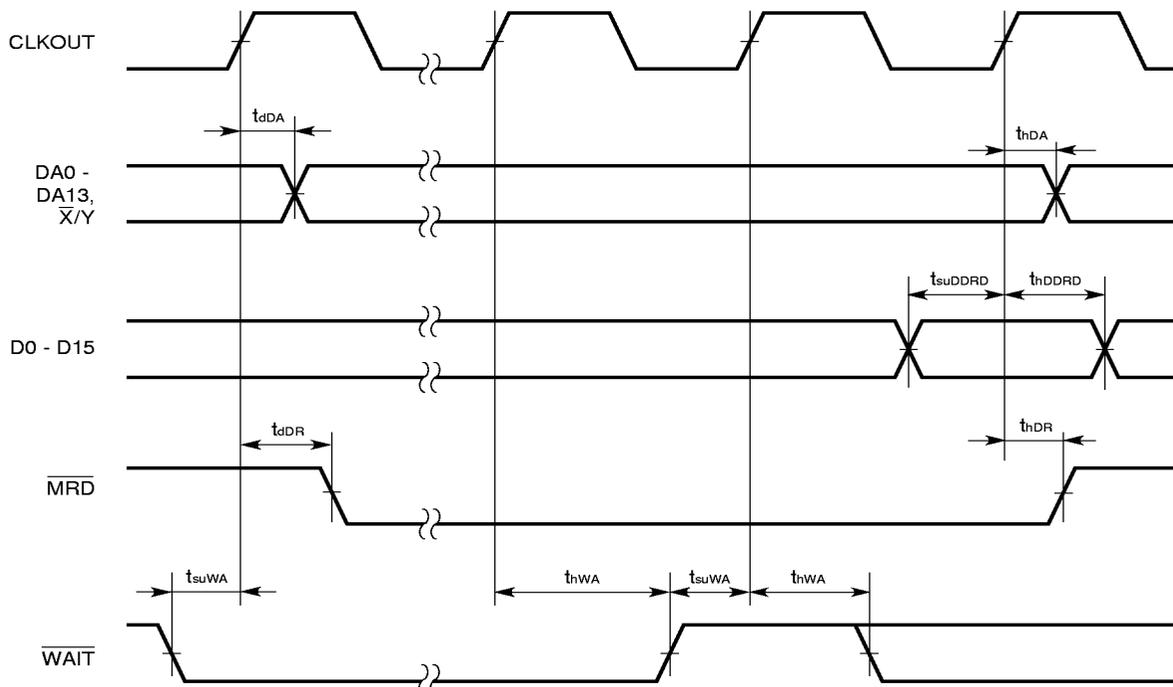

External Data Memory Access Timing (Write)

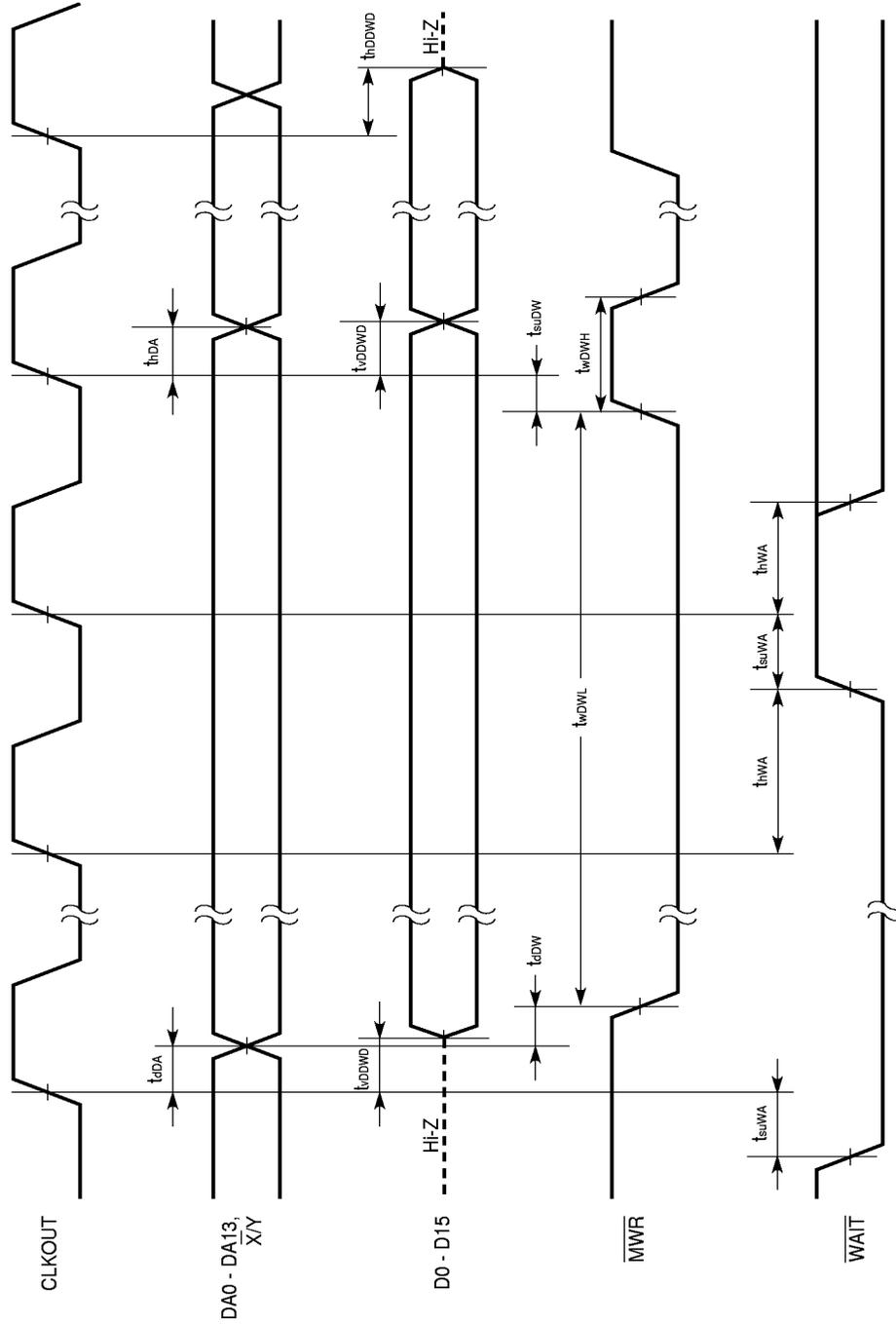

**Bus Arbitration**

**Required Timing Condition**

Parameters	Symbol	Conditions	MIN.	TYP.	MAX.	Unit
$\overline{\text{HOLDRQ}}$ setup time	$t_{\text{suHRQ}}$		12			ns
$\overline{\text{HOLDRQ}}$ hold time	$t_{\text{hHRQ}}$		0			ns

**Switching Characteristics**

Parameters	Symbol	Conditions	MIN.	TYP.	MAX.	Unit
$\overline{\text{BSTB}}$ hold time	$t_{\text{hBS}}$		0			ns
$\overline{\text{BSTB}}$ output delay time	$t_{\text{dBS}}$				12	ns
$\overline{\text{HOLDAK}}$ output delay time	$t_{\text{dHAK}}$				12	ns
Data hold time when bus arbitration	$t_{\text{h(BS-D)}}$				30	ns
Data valid time after bus arbitration	$t_{\text{v(BS-D)}}$				15	ns

Bus Arbitration Timing (Bus idle)

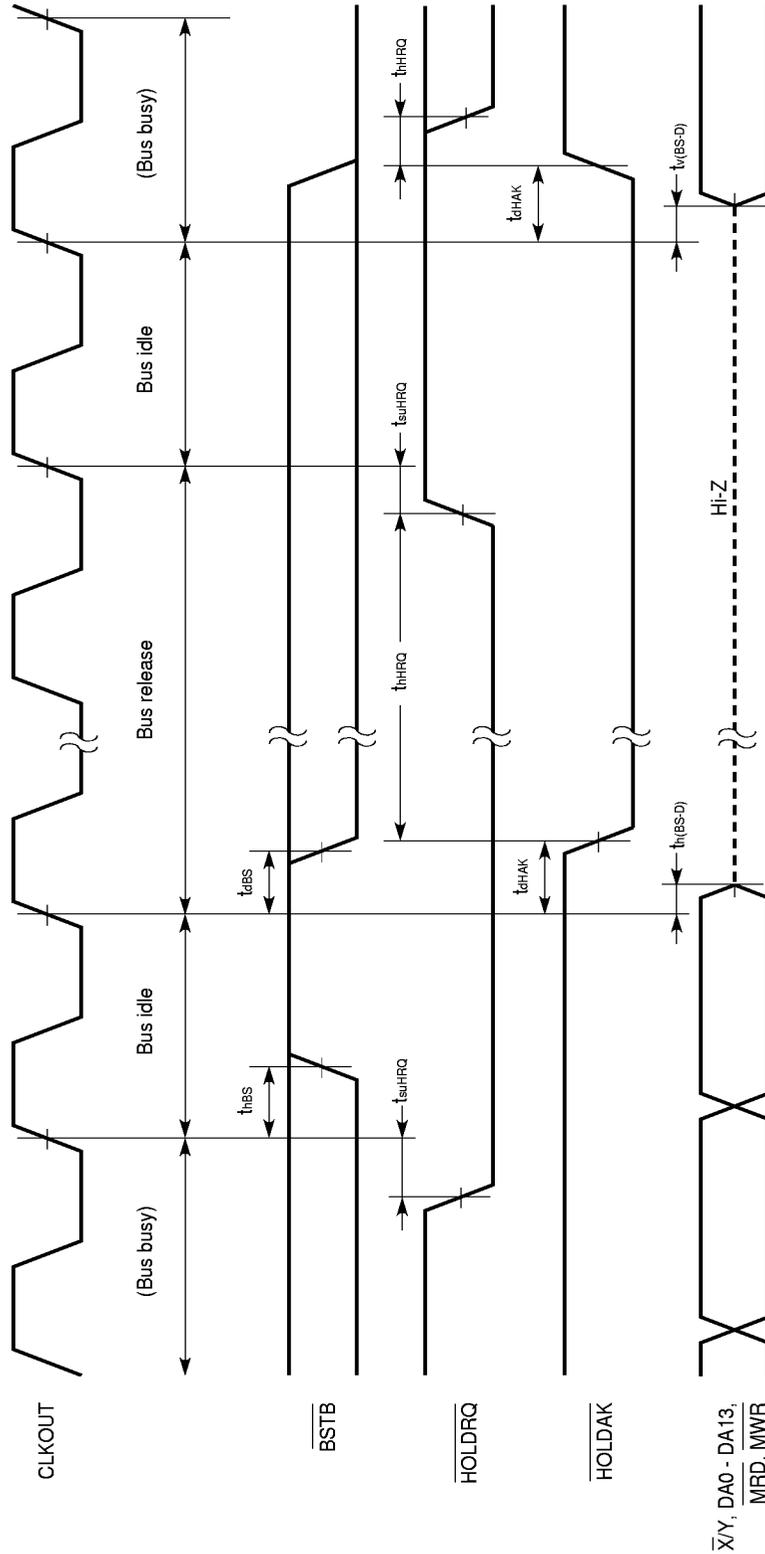

Bus Arbitration Timing (Bus busy)

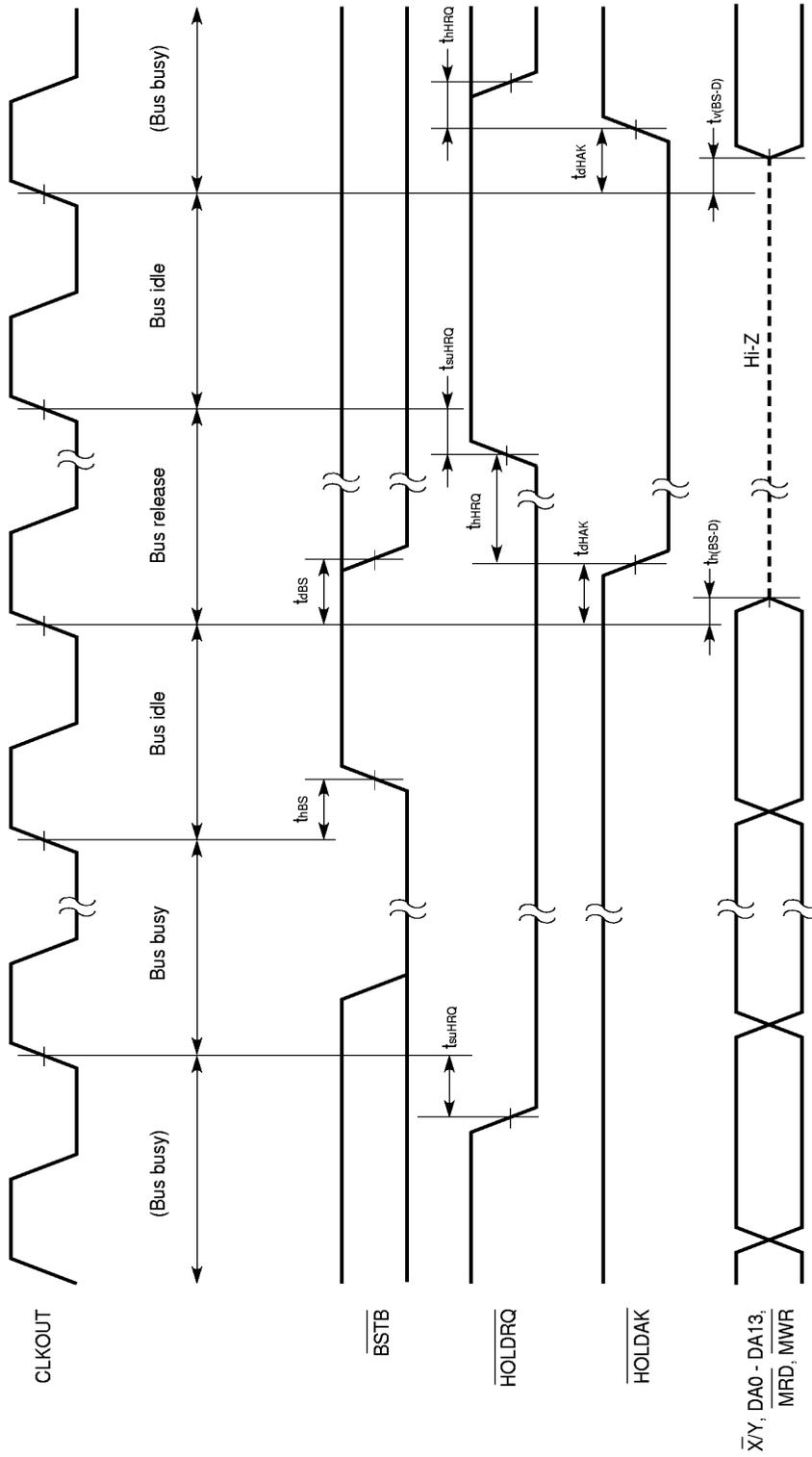

**Serial Interface**

**Required Timing Condition**

Parameters	Symbol	Conditions	MIN.	TYP.	MAX.	Unit
SCK input cycle time	$t_{cSC}$		$2t_{cC}$			ns
SCK input high/low level width	$t_{wSC}$		25			ns
SCK input rise/fall time	$t_{r/fSC}$				20	ns
SOEN recovery time	$t_{recSOE}$		20			ns
SOEN hold time	$t_{hSOE}$		0			ns
SIEN recovery time	$t_{recSIE}$		20			ns
SIEN hold time	$t_{hSIE}$		0			ns
SI setup time	$t_{suSI}$		20			ns
SI hold time	$t_{hSI}$		0			ns

**Switching Characteristics**

Parameters	Symbol	Conditions	MIN.	TYP.	MAX.	Unit
SORQ output delay time	$t_{dSOR}$				30	ns
SORQ hold time	$t_{hSOR}$		0			ns
SO valid time	$t_{vSO}$				30	ns
SO hold time	$t_{hSO}$		0			ns
SI AK output delay time	$t_{dSIA}$				30	ns
SI AK hold time	$t_{hSIA}$		0			ns

★ **Notes for Serial Clock**

Serial clock inputs SCK1 and SCK2 are sensitive to any kind of interfering signals (noise on power supply, induced voltage, etc.). Spurious signals can cause malfunction of the device. Special care for the serial clock design should be taken. Careful grounding, decoupling and short wiring of SCK1 and SCK2 are recommended. Intersection of SCK1 and SCK2 with other serial interface lines or close wiring to lines carrying high frequency signals or large changing currents should be avoided.

It considers for the serial clock to make a waveform stable especially about the rising and falling.



**Example 1. good example**  
Straight rising form and falling form



**Example 2. no good example**  
It doesn't bound. It doesn't make noise one above another.



**Example 3. no good example**  
It doesn't make a stair stepping.

Serial Output Timing 1

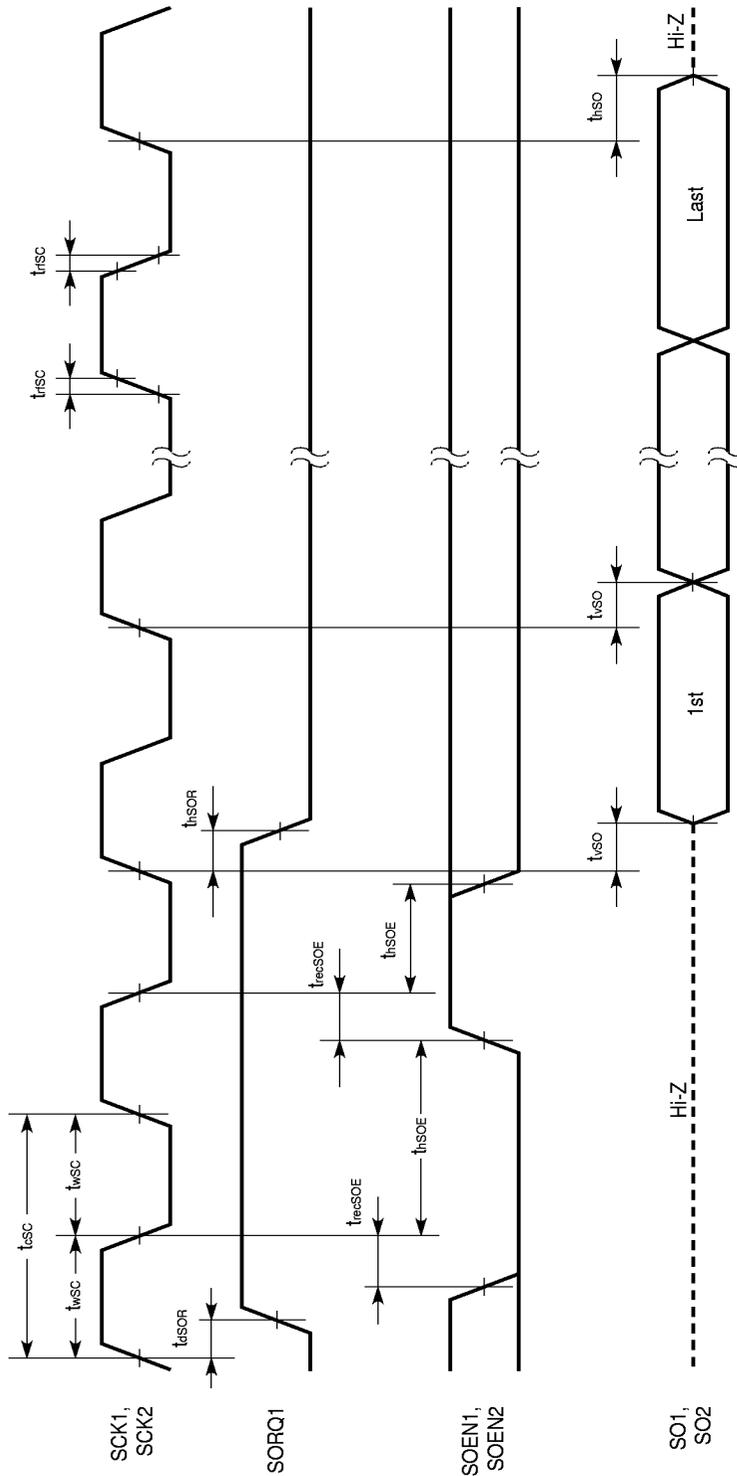

Serial Output Timing 2 (Continual output)

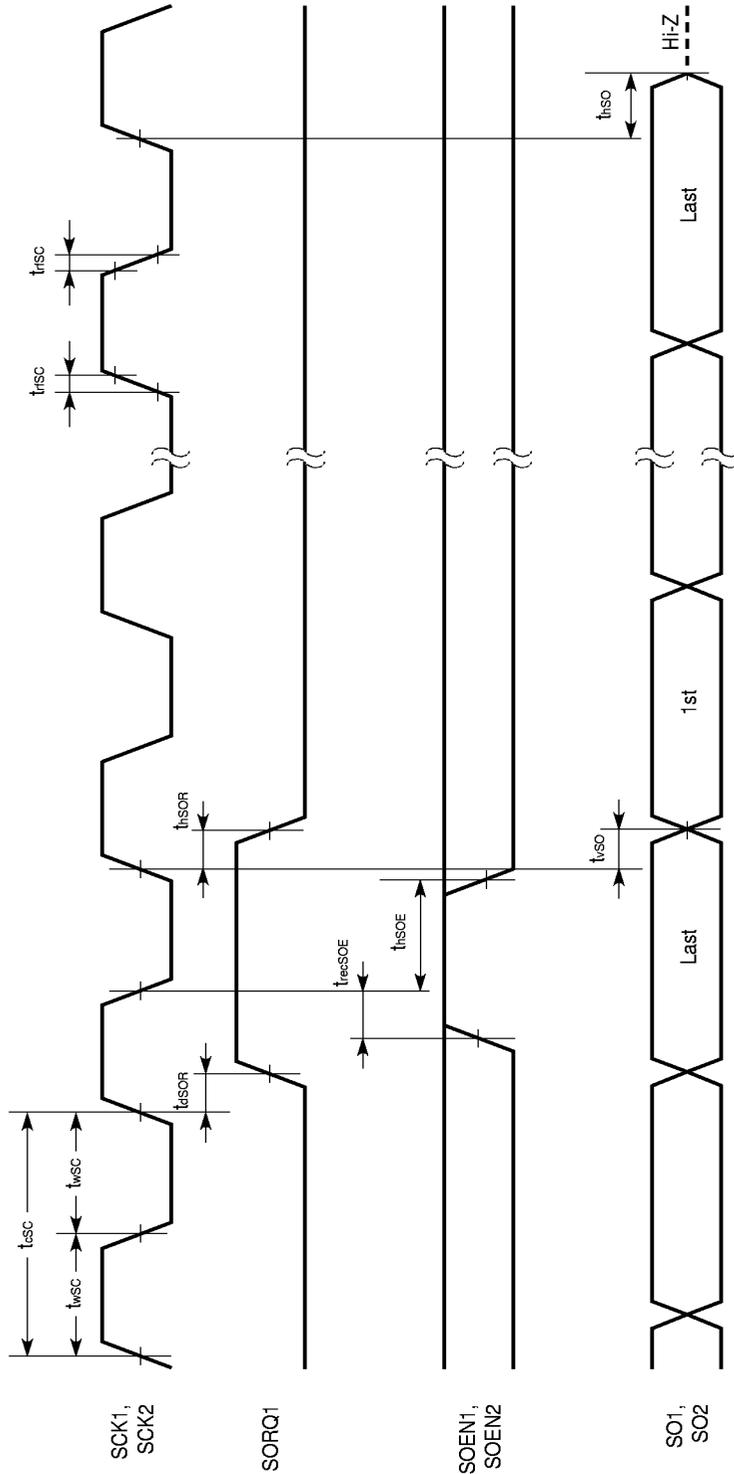

Serial Input Timing 1

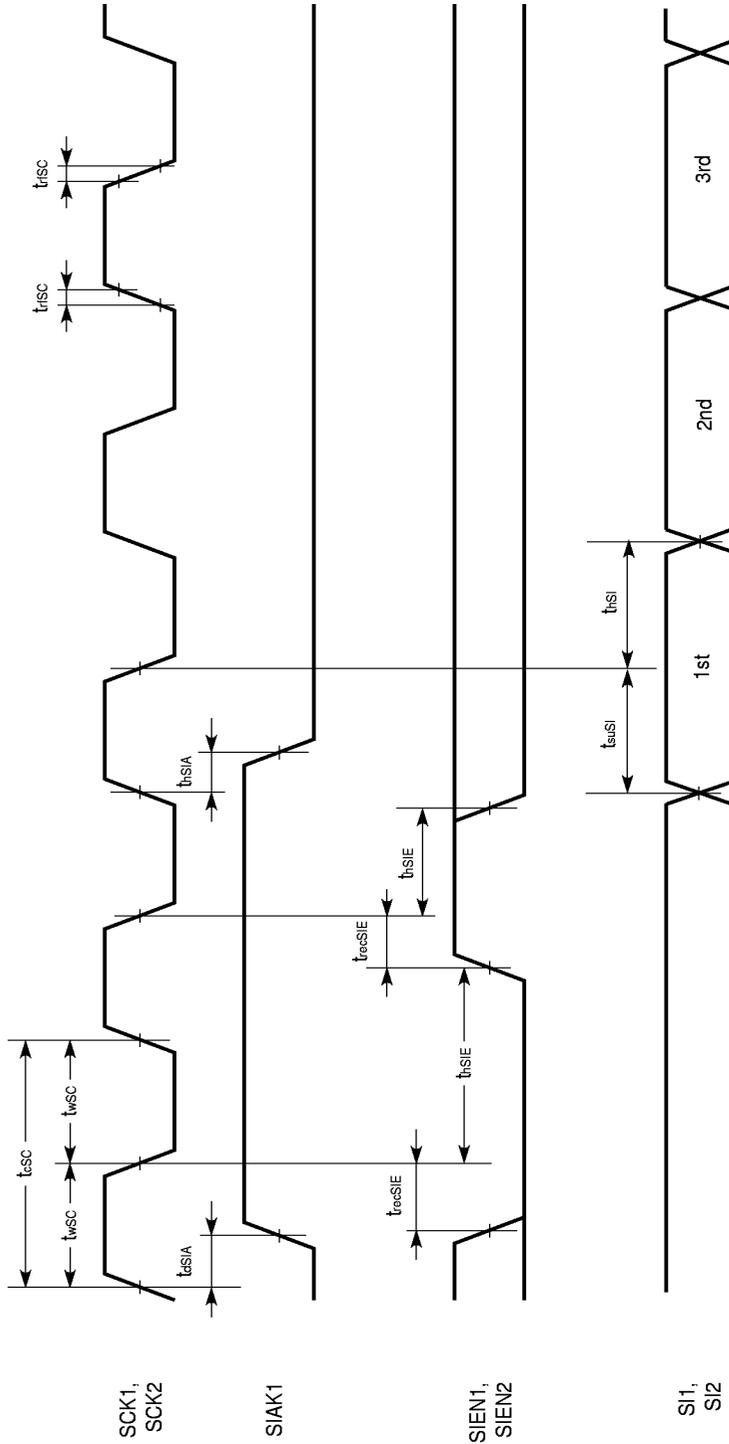

Serial Input Timing 2 (Continual Input)

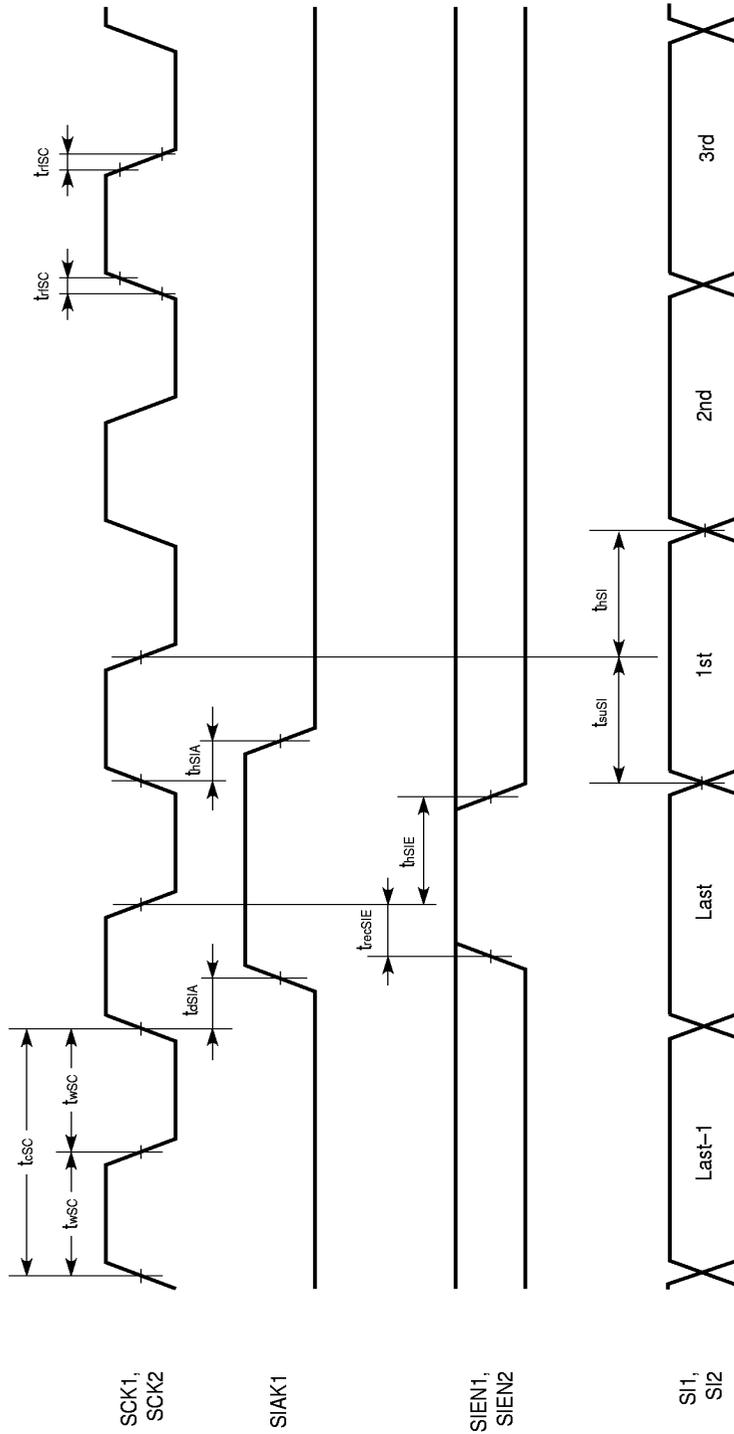

**Host Interface**

**Required Timing Condition**

Parameters	Symbol	Conditions	MIN.	TYP.	MAX.	Unit
$\overline{\text{HRD}}$ delay time	$t_{dHR}$		0			ns
$\overline{\text{HRD}}$ width	$t_{wHR}$		$2t_{cc}$			ns
$\overline{\text{HCS}}$ , HA0, HA1 read hold time	$t_{hCAR}$		0			ns
$\overline{\text{HCS}}$ , HA0, HA1 write hold time	$t_{hCAW}$		0			ns
$\overline{\text{HRD}}$ , $\overline{\text{HWR}}$ recovery time	$t_{recHS}$		$2t_{cc}$			ns
$\overline{\text{HWR}}$ delay time	$t_{dHW}$		0			ns
$\overline{\text{HWR}}$ width	$t_{wHW}$		$2t_{cc}$			ns
$\overline{\text{HWR}}$ hold time	$t_{hHDW}$		0			ns
$\overline{\text{HWR}}$ setup time	$t_{suHDW}$		20			ns

**Switching Characteristics**

Parameters	Symbol	Conditions	MIN.	TYP.	MAX.	Unit
$\overline{\text{HRE}}$ , $\overline{\text{HWE}}$ output delay time	$t_{dHE}$				30	ns
$\overline{\text{HRE}}$ , $\overline{\text{HWE}}$ hold time	$t_{hHE}$				30	ns
$\overline{\text{HRD}}$ valid time	$t_{vHDR}$				30	ns
$\overline{\text{HRD}}$ hold time	$t_{hHDR}$		0			ns

Host Interface Timing (Read)

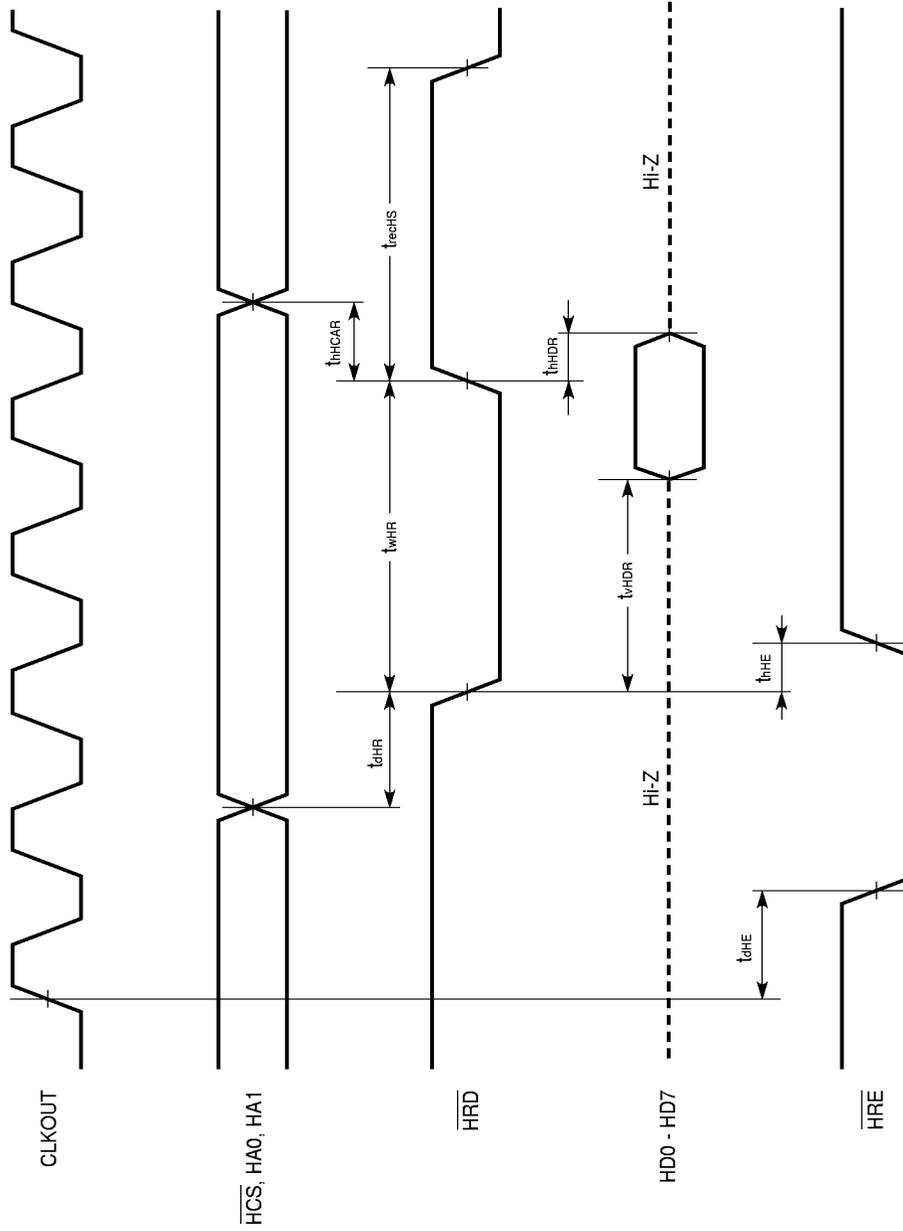

Host Interface Timing (Write)

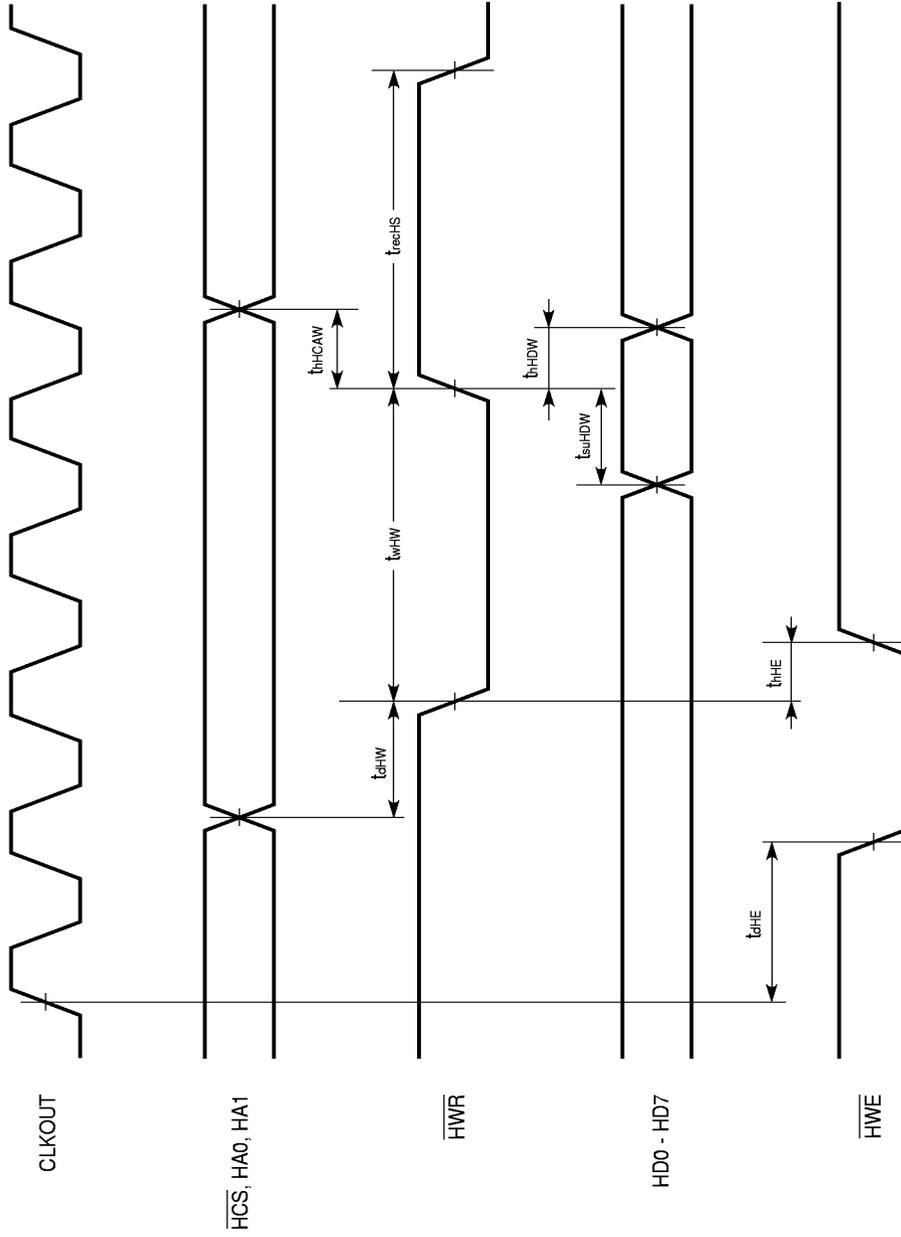

**General Input/Output Ports**

**Required Timing Condition**

Parameters	Symbol	Conditions	MIN.	TYP.	MAX.	Unit
Port input setup time	$t_{suPI}$		20			ns
Port input hold time	$t_{hPI}$		10			ns

**Switching Characteristics**

Parameters	Symbol	Conditions	MIN.	TYP.	MAX.	Unit
Port output delay time	$t_{dPO}$		0		30	ns

**General Input/Output Ports Timing**

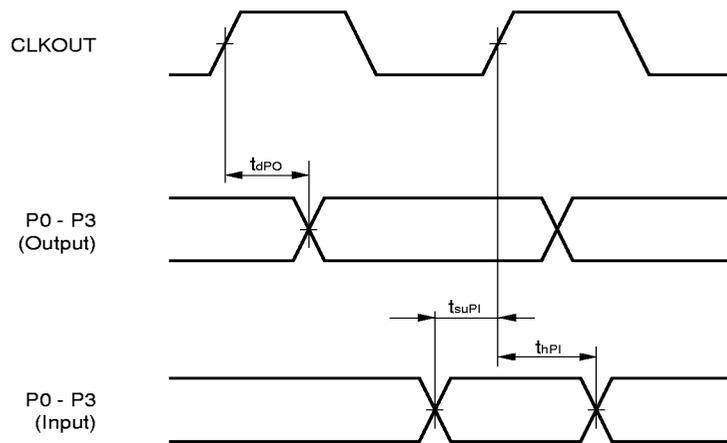

**Debugging Interface (JTAG)**

**Required Timing Condition**

Parameters	Symbol	Conditions	MIN.	TYP.	MAX.	Unit
TCK cycle time	$t_{cTCK}$		$4t_{cc}$			ns
TCK high/low level width	$t_{wTCK}$		50			ns
TCK rise/fall time	$t_{rTCK}$				20	ns
TMS, TDI setup time	$t_{sUDI}$		10			ns
TMS, TDI hold time	$t_{hDI}$		0			ns
Input pin setup time	$t_{sUJIN}$		10			ns
Input pin hold time	$t_{hJIN}$		0			ns

**Switching Characteristics**

Parameters	Symbol	Conditions	MIN.	TYP.	MAX.	Unit
TDO output delay time	$t_{dDO}$				30	ns
Output pin output delay time	$t_{dJOUT}$				30	ns

**Debugging Interface Timing**

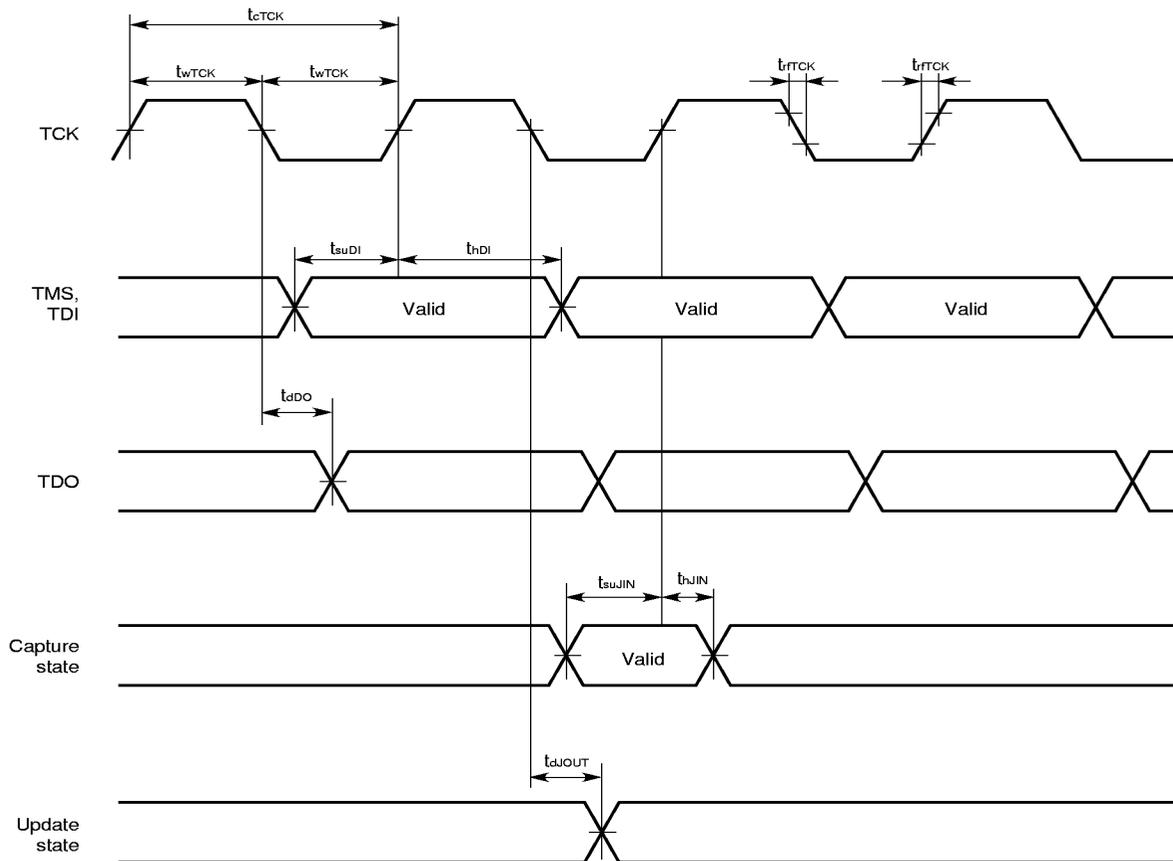

**Remark** For the details of JTAG, refer to "IEEE1149.1."

5. PACKAGE DRAWING

100 PIN PLASTIC TQFP (FINE PITCH) (□14)

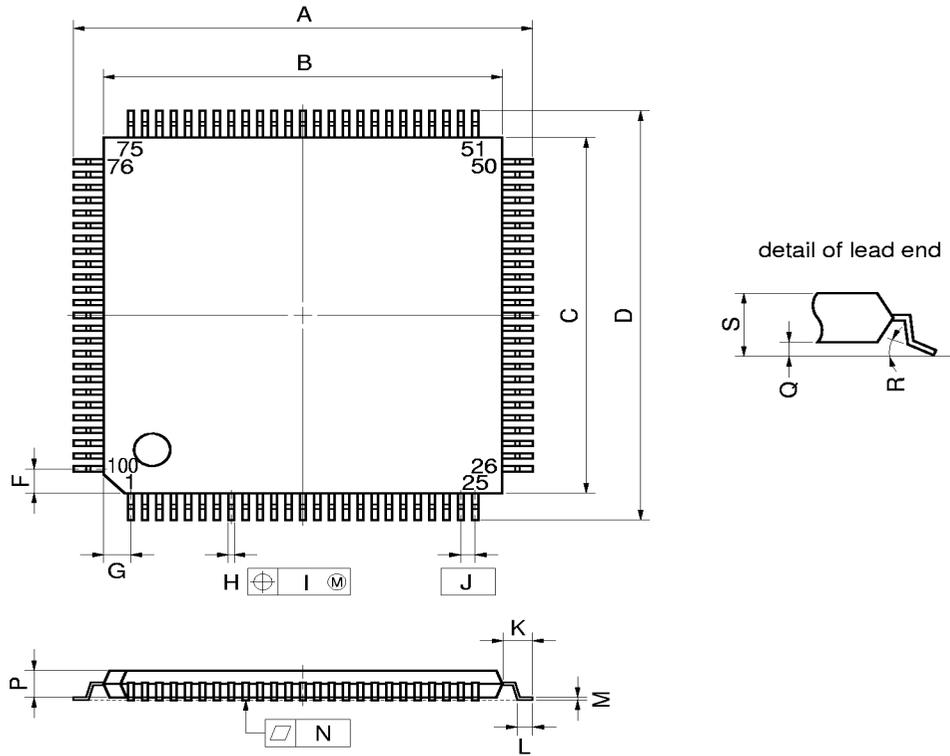

NOTE

Each lead centerline is located within 0.10 mm (0.004 inch) of its true position (T.P.) at maximum material condition.

ITEM	MILLIMETERS	INCHES
A	16.0±0.2	0.630±0.008
B	14.0±0.2	0.551 <sup>+0.009</sup> <sub>-0.008</sub>
C	14.0±0.2	0.551 <sup>+0.009</sup> <sub>-0.008</sub>
D	16.0±0.2	0.630±0.008
F	1.0	0.039
G	1.0	0.039
H	0.22 <sup>+0.05</sup> <sub>-0.04</sub>	0.009±0.002
I	0.10	0.004
J	0.5 (T.P.)	0.020 (T.P.)
K	1.0±0.2	0.039 <sup>+0.009</sup> <sub>-0.008</sub>
L	0.5±0.2	0.020 <sup>+0.008</sup> <sub>-0.009</sub>
M	0.145 <sup>+0.055</sup> <sub>-0.045</sub>	0.006±0.002
N	0.10	0.004
P	1.0±0.1	0.039 <sup>+0.005</sup> <sub>-0.004</sub>
Q	0.1±0.05	0.004±0.002
R	3° <sup>+7°</sup> <sub>-3°</sub>	3° <sup>+7°</sup> <sub>-3°</sub>
S	1.27 MAX.	0.050 MAX.

S100GC-50-9EU-1

**6. RECOMMENDED SOLDERING CONDITIONS**

When soldering these products, it is highly recommended to observe the conditions as shown below. If other soldering processes are used, or if the soldering is performed under different conditions, please make sure to consult with our sales offices.

For more details, refer to our document “**SEMICONDUCTOR DEVICE MOUNTING TECHNOLOGY MANUAL**” (C10535E).

**Surface Mount Device**

μPD77018AGC-xxx-9EU: 100-pin plastic TQFP (FINE PITCH) (14 × 14mm)

μPD77019GC-xxx-9EU: 100-pin plastic TQFP (FINE PITCH) (14 × 14mm)

Process	Conditions	Symbol
Infrared ray reflow	Peak temperature: 235 °C or below (Package surface temperature), Reflow time: 30 seconds or less (at 210 °C or higher), Maximum number of reflow processes : 2 times, Exposure limit <b>Note</b> : 3 days (10 hours pre-baking is required at 125 °C afterwards).	IR35-103-2
Vapor Phase Soldering	Peak temperature: 215 °C or below (Package surface temperature), Reflow time: 40 seconds or less (at 200 °C or higher), Maximum number of reflow processes : 2 times, Exposure limit <b>Note</b> : 3 days (10 hours pre-baking is required at 125 °C afterwards).	VP15-103-2
Partial heating method	Pin temperature : 300 °C or below, Heat time : 3 seconds or less (Per each side of the device)	_____

**Note** Maximum allowable time from taking the soldering package out of dry pack to soldering.  
Storage conditions: 25 °C and relative humidity of 65 % or less.

**Caution** Apply only one kind of soldering condition to a device, except for “partial heating method”, or the device will be damaged by heat stress.