

DATA SHEET

DC25-73, DC25-73LF: Directional Coupler 2.3–2.6 GHz

Features

- Low cost
- Low profile
- Available in small SOT-6 package
- Available on tape and reel
- Available lead (Pb)-free and RoHS-compliant MSL-1 @ 260 °C per JEDEC J-STD-020

Block Diagram

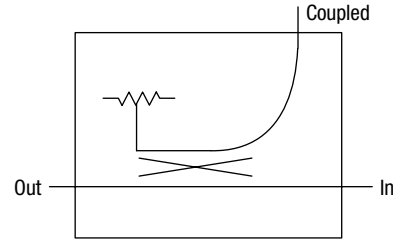

Description

The DC25-73 is a monolithic directional coupler tailored to the 2.3–2.6 GHz band. It offers low loss, good isolation, good input/output matching and exceptional coupling repeatability. It is available in the SOT-6 surface mount package.

NEW Skyworks offers lead (Pb)-free, RoHS (Restriction of Hazardous Substances)-compliant packaging.



Electrical Specifications at 25 °C

$Z_0 = 50 \Omega$, unless otherwise noted

Parameter	Frequency	Min.	Typ.	Max.	Unit
Frequency		2.3		2.6	GHz
Insertion loss			0.2	0.3	dB
Isolation		30	33		dB
Input VSWR			1.1:1	1.3:1	
Output VSWR			1.1:1	1.3:1	
Coupling		19	18	17	dB
Coupled port VSWR			1.3:1	1.5:1	

Pin Out

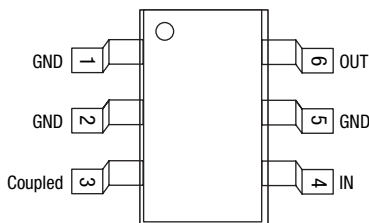

 Innovation to Go™
Now available for purchase online.

Typical Performance Data

$Z_0 = 50 \Omega$, unless otherwise noted

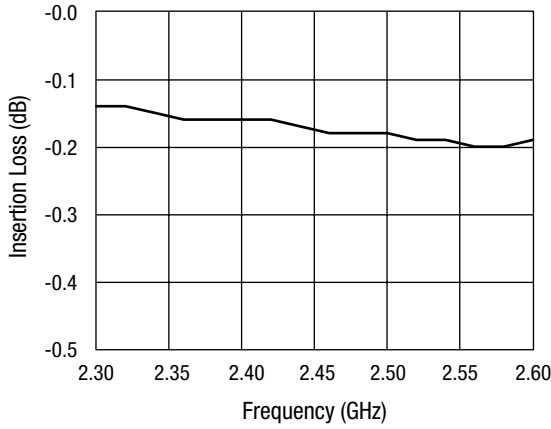

Insertion Loss vs. Frequency

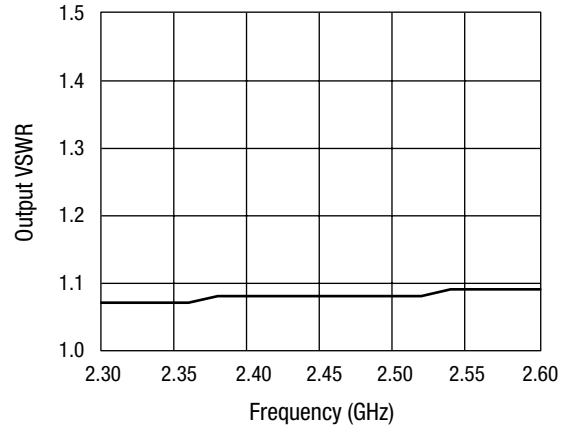

Output VSWR vs. Frequency

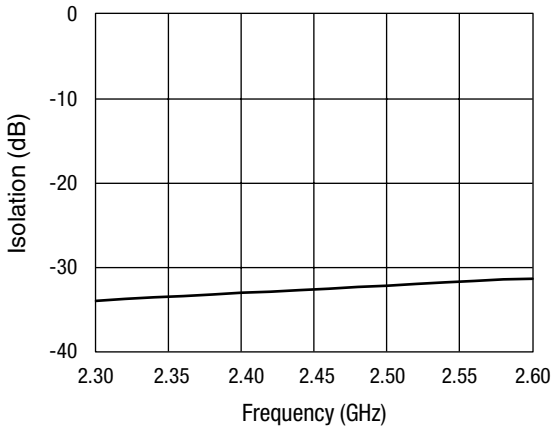

Isolation vs. Frequency

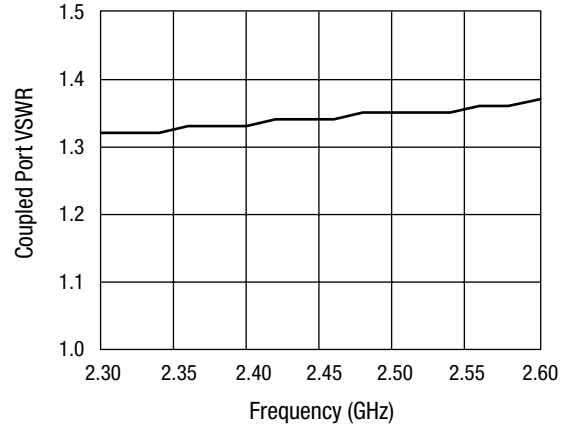

Coupled Port VSWR vs. Frequency

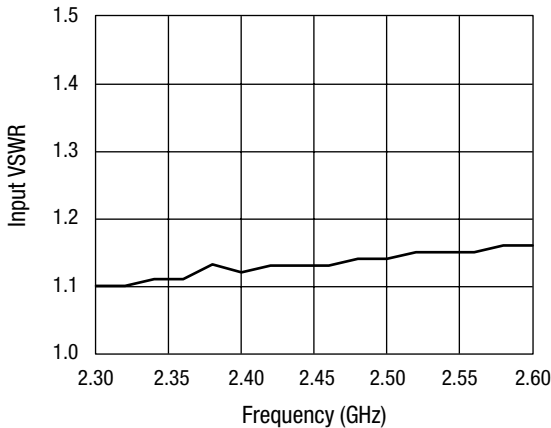

Input VSWR vs. Frequency

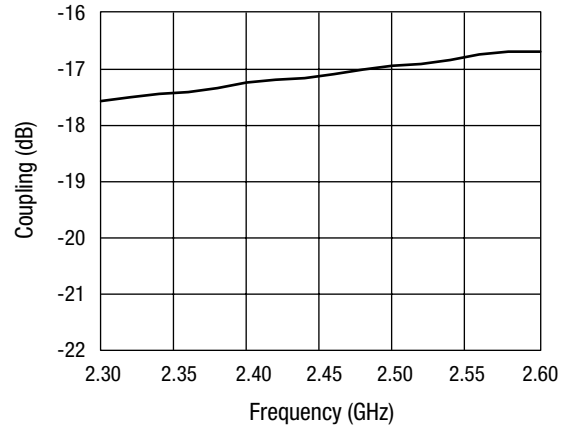

Coupling vs. Frequency

Absolute Maximum Ratings

Characteristic	Value
Input Power ⁽¹⁾	4 W CW
Operating Temperature	-40 °C to +85 °C
Storage Temperature	-65 °C to +150 °C

1. When operating with a 2.0:1 maximum VSWR on all ports. Performance is guaranteed only under the conditions listed in the specifications table and is not guaranteed under the full range(s) described by the Absolute Maximum specifications. Exceeding any of the absolute maximum/minimum specifications may result in permanent damage to the device and will void the warranty.

CAUTION: Although this device is designed to be as robust as possible, ESD (Electrostatic Discharge) can damage this device. This device must be protected at all times from ESD. Static charges may easily produce potentials of several kilovolts on the human body or equipment, which can discharge without detection. Industry-standard ESD precautions must be employed at all times.

Recommended Solder Reflow Profiles

Refer to the “Recommended Solder Reflow Profile” Application Note.

Tape and Reel Information

Refer to the “Discrete Devices and IC Switch/Attenuators Tape and Reel Package Orientation” Application Note.

Recommended Board Layout

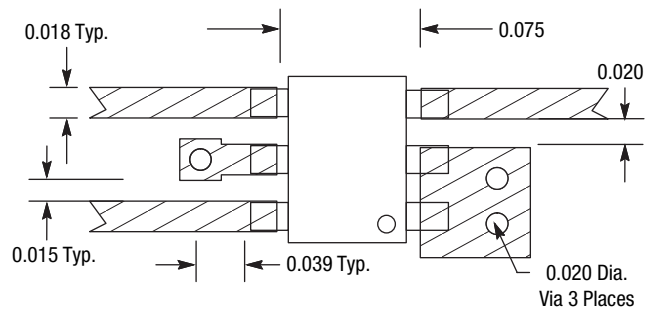

Material is 10 mil FR4.

SOT-6

