

Typical Applications

High Dynamic Range Infrastructure:

- GSM, GPRS & EDGE
- CDMA & W-CDMA
- Cable Modem Termination Systems

Features

- +34 dBm Input IP3
- Conversion Loss: 9 dB
- Low LO Drive: -2 to +4 dBm
- Single Positive Supply: 5V @ 45 mA
- Ultra Small MSOP Package: 14.8mm²
- Included in the HMC-DK003 Designer's Kit

Functional Diagram

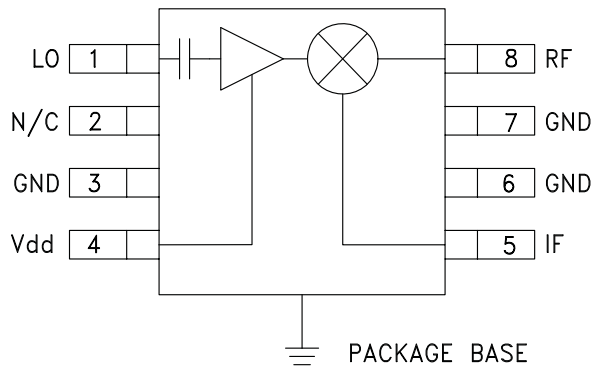

General Description

The HMC485MS8G & HMC485MS8GE are high dynamic range passive MMIC mixers with integrated LO amplifier in plastic surface mount 8 lead Mini Small Outline Packages (MSOP) covering 1.7 to 2.4 GHz. Excellent input IP3 performance of +34 dBm for down conversion and +27 dBm for up conversion is provided for 2.5G & 3G GSM/CDMA based UMTS or PCS applications at an LO drive of 0 dBm. With an input 1 dB compression of +19 dBm, the RF port will accept a wide range of input signal levels. Conversion loss is 9.2 dB typical. The 50 to 300 MHz IF frequency response will satisfy many UMTS/PCS transmit or receive frequency plans configured for low side LO. The HMC485MS8G(E) input IP3 performance coupled with its high P1dB rivals traditional active FET mixers while offering a much smaller 14.8mm² standard IC footprint.

Electrical Specifications, $T_A = +25^\circ\text{C}$, LO = 0 dBm, IF = 200 MHz*, Vdd = 5V

Parameter	Min.	Typ.	Max.	Min.	Typ.	Max.	Min.	Typ.	Max.	Min.	Typ.	Max.	Units
Frequency Range, RF		1.7 - 1.8		1.8 - 2.0		2.0 - 2.2		2.2 - 2.4					GHz
Frequency Range, LO		1.4 - 1.75		1.5 - 1.95		1.7 - 2.15		1.9 - 2.35					GHz
Frequency Range, IF		50 - 300		50 - 300		50 - 300		50 - 300					MHz
Conversion Loss		9.8	11		9.2	10.5		9	10		9.5	10.5	dB
Noise Figure (SSB)		9.8			9.2			9			9.5		dB
LO to RF Isolation		12			8			5			5		dB
LO to IF Isolation		7			10			13			12		dB
IP3 (Input)	27	31		29	34		29	33		29	32		dBm
1 dB Gain Compression (Input)	16	19		17	20		17	21		18.5	21.5		dBm
LO Input Drive Level (Typical)		-2 to +4		-2 to +4		-2 to +4		-2 to +4			-2 to +4		dBm
Supply Current		45			45			45			45		mA

*Unless otherwise noted, all measurements performed as a downconverter, with low side LO & IF = 200 MHz.



HIGH IP3 GaAs MMIC MIXER with INTEGRATED LO AMPLIFIER, 1.7 - 2.4 GHz

Conversion Gain vs. Temperature @ LO = 0 dBm

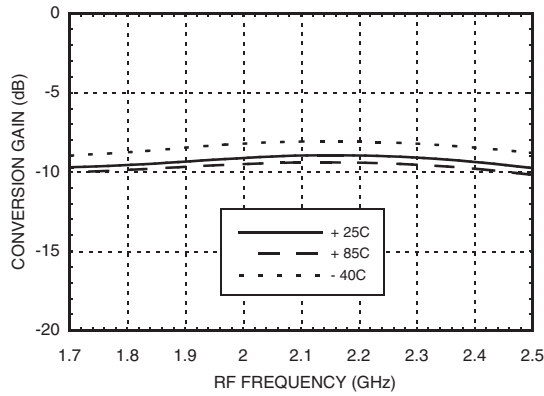

Isolation @ LO = 0 dBm

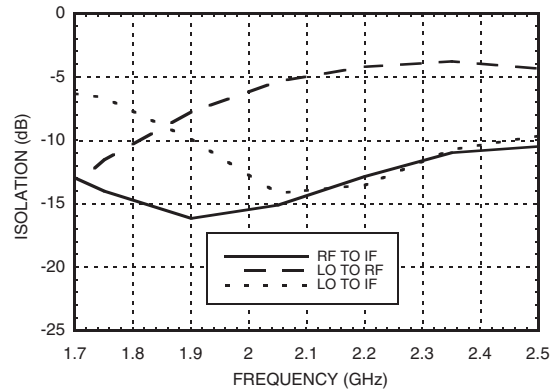

Conversion Gain vs. LO Drive

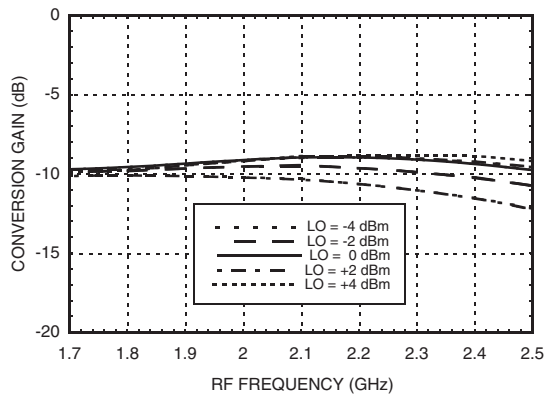

Return Loss @ LO = 0 dBm

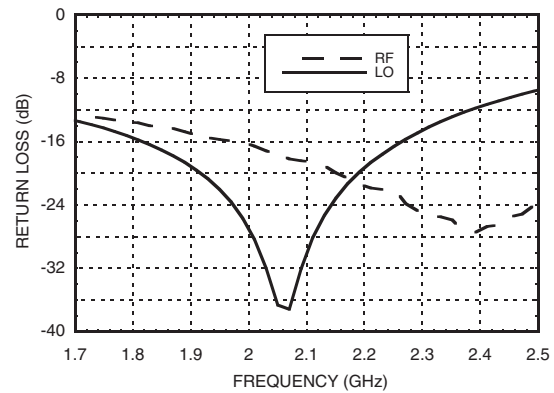

Upconverter Performance Conversion Gain @ LO = 0 dBm

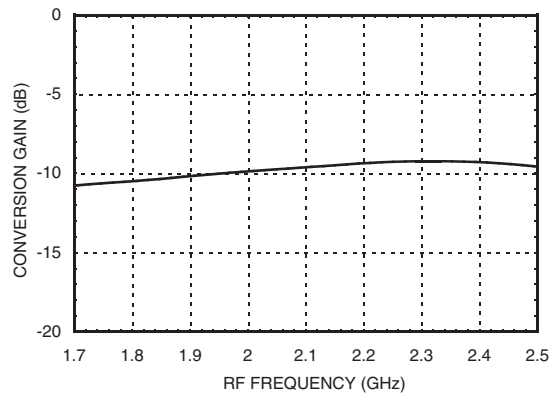

IF Bandwidth @ LO = 0 dBm

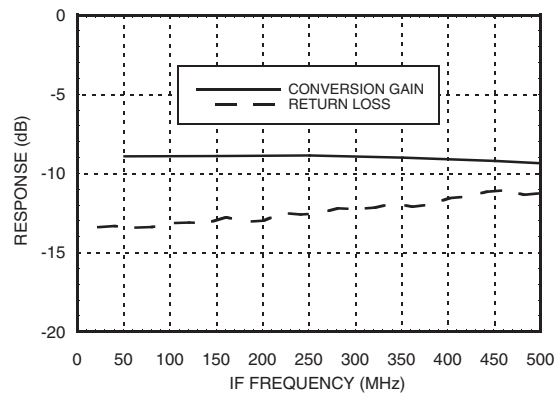

*Unless otherwise noted, all measurements performed as a downconverter, with low side LO & IF = 200 MHz.

For price, delivery, and to place orders, please contact Hittite Microwave Corporation:
 20 Alpha Road, Chelmsford, MA 01824 Phone: 978-250-3343 Fax: 978-250-3373
 Order On-line at www.hittite.com



HIGH IP3 GaAs MMIC MIXER with INTEGRATED LO AMPLIFIER, 1.7 - 2.4 GHz

Input IP3 vs. Temperature @ LO= 0 dBm

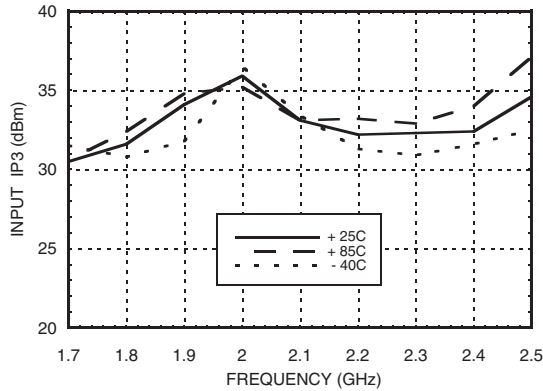

Input IP3 vs. LO Drive

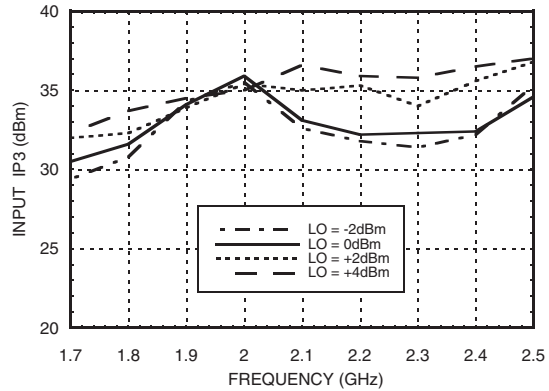

Input IP2 vs. Temperature @ LO= 0 dBm

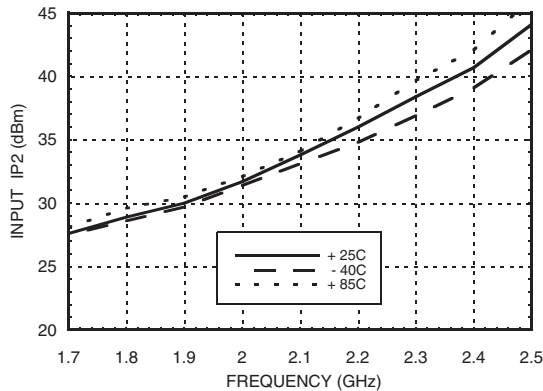

Input IP2 vs. LO Drive @ IF= 200 MHz

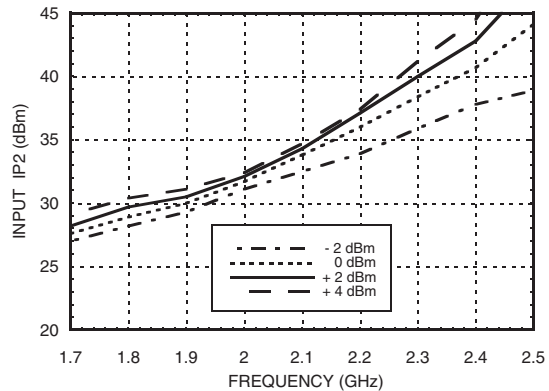

Input P1dB vs. Temperature @ LO= 0 dBm

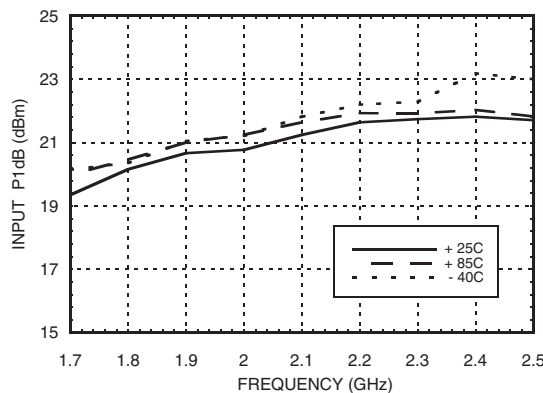

Upconverter IP3 vs. LO Drive, IF= 200 MHz

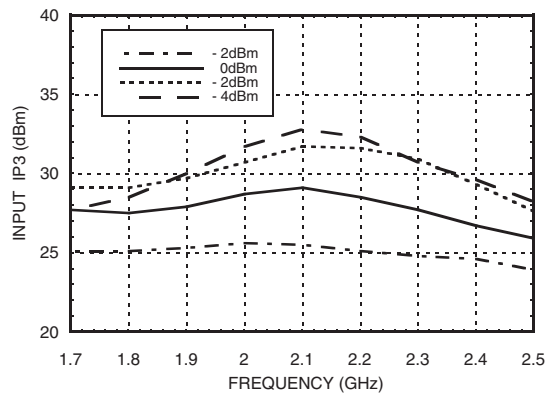

Input IP3 vs. LO Drive, IF= 70 MHz

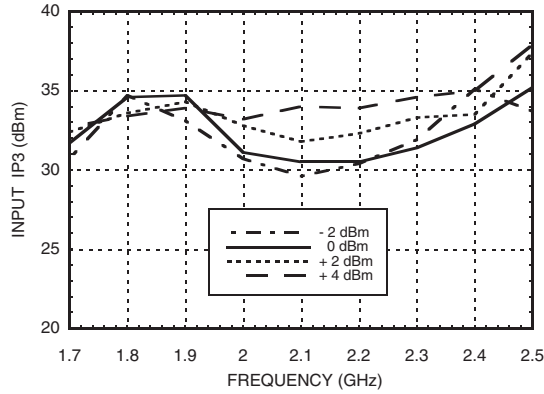

Input IP3 vs. LO Drive, IF= 120 MHz

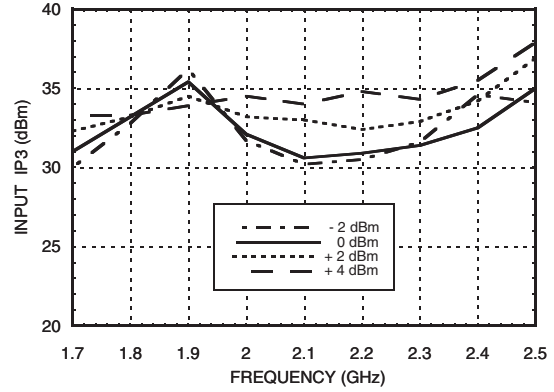

Input IP3 vs. LO Drive, IF= 170 MHz

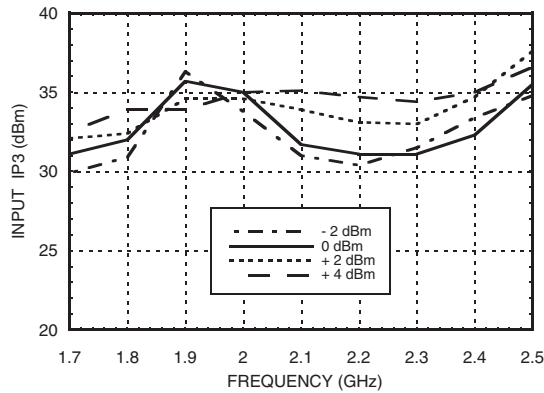

Input IP3 vs. LO Drive, IF= 247 MHz

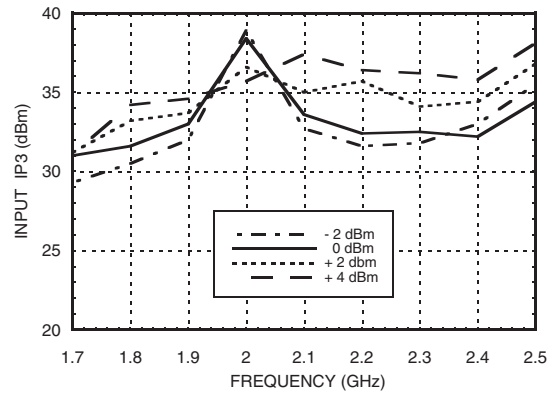

Input IP3 vs. LO Drive, IF= 297 MHz

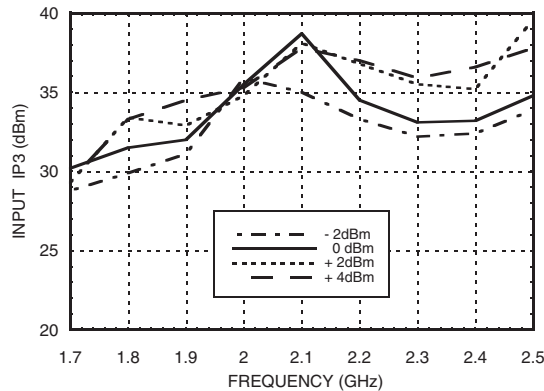



MICROWAVE CORPORATION v03.0507



HMC485MS8G / 485MS8GE

HIGH IP3 GaAs MMIC MIXER with INTEGRATED LO AMPLIFIER, 1.7 - 2.4 GHz

MxN Spurious Outputs

mRF	nLO				
	0	1	2	3	4
0	xx	-1.	19	15	15
1	4	0	30	25	44
2	54	69	39	56	55
3	75	82	83	74	72
4	78	82	83	83	82

RF Freq = 1.9 GHz @ 0 dBm
 LO Freq = 1.7 GHz @ 0 dBm
 All values in dBc Relative to the IF power level.

Harmonics of LO

LO Freq GHz	nLO Spur at RF Port			
	1	2	3	4
1.5	19	15	35	24
1.6	17	15	33	24
1.7	14	14	29	23
1.8	10	15	25	24
1.9	8	20	22	23
2	6	20	22	24

LO power = 0 dBm
 All values in dBc below input LO level measured at RF port.

Absolute Maximum Ratings

RF/IF Input	+27 dBm
LO Drive	+10 dBm
Bias Supply (Vdd)	+7 Vdc
Channel Temperature	150 °C
Continuous Pdiss (T = 85°C) (Derate 13.2 mW/°C above 85°C)	0.85 W
Storage Temperature	-65 to +150 °C
Operating Temperature	-40 to +85 °C
IF DC Current	±40 mA
ESD Sensitivity (HBM)	Class 1A



ELECTROSTATIC SENSITIVE DEVICE
OBSERVE HANDLING PRECAUTIONS

Outline Drawing

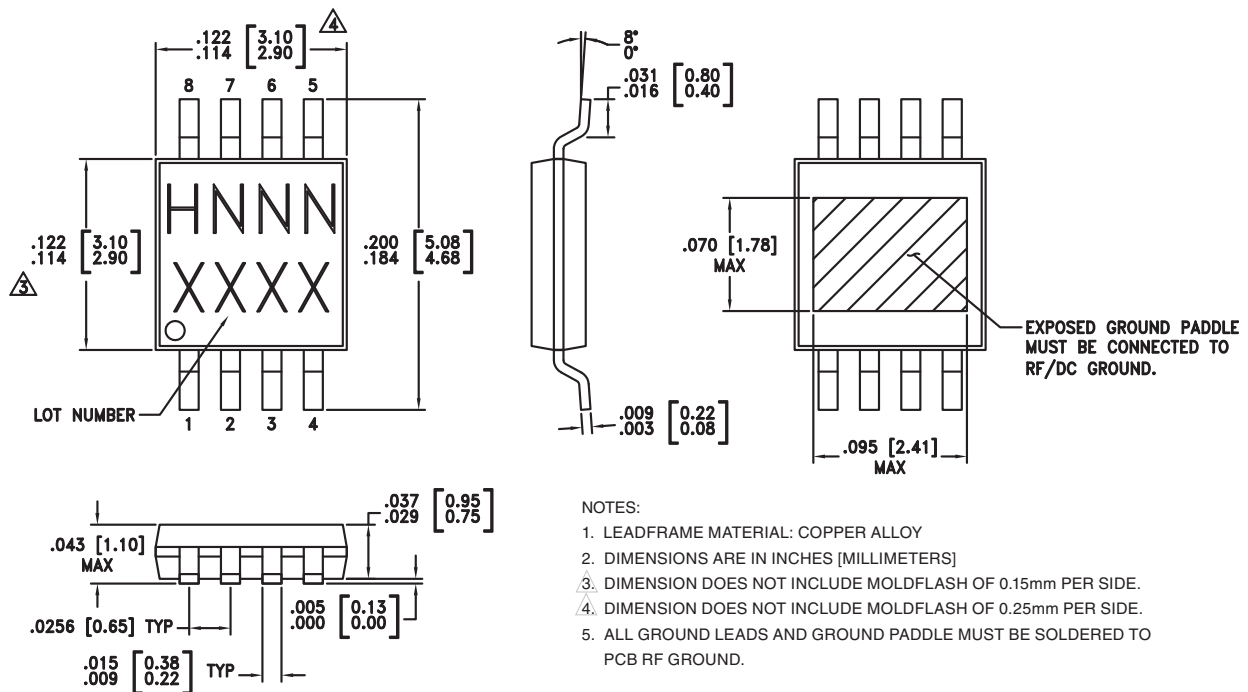

Package Information

Part Number	Package Body Material	Lead Finish	MSL Rating	Package Marking ^[3]
HMC485MS8G	Low Stress Injection Molded Plastic	Sn/Pb Solder	MSL1 ^[1]	H485 XXXX
HMC485MS8GE	RoHS-compliant Low Stress Injection Molded Plastic	100% matte Sn	MSL1 ^[2]	<u>H485</u> XXXX



[1] Max peak reflow temperature of 235 °C

[2] Max peak reflow temperature of 260 °C

[3] 4-Digit lot number XXXX

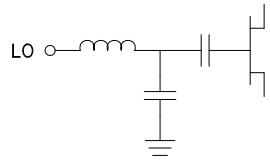

Pin Descriptions

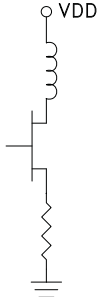
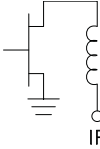
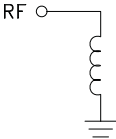
Pin Number	Function	Description	Interface Schematic
1	LO	This pin is AC coupled and matched to 50 Ohms.	
2	N/C	Not connected.	
3, 6, 7	GND	This pin must be connected to RF ground.	
4	Vdd	Power supply for LO amplifier. An external RF bypass capacitor is required.	
5	IF Port	This pin is DC coupled. For applications not requiring operation to DC this port should be DC blocked externally using a series capacitor. Choose value of capacitor to pass IF frequency desired. For operation to DC, this pin must not sink/source more than 40 mA of current or failure may result.	
8	RF Port	This pin is DC coupled and matched to 50 Ohms.	

Evaluation PCB

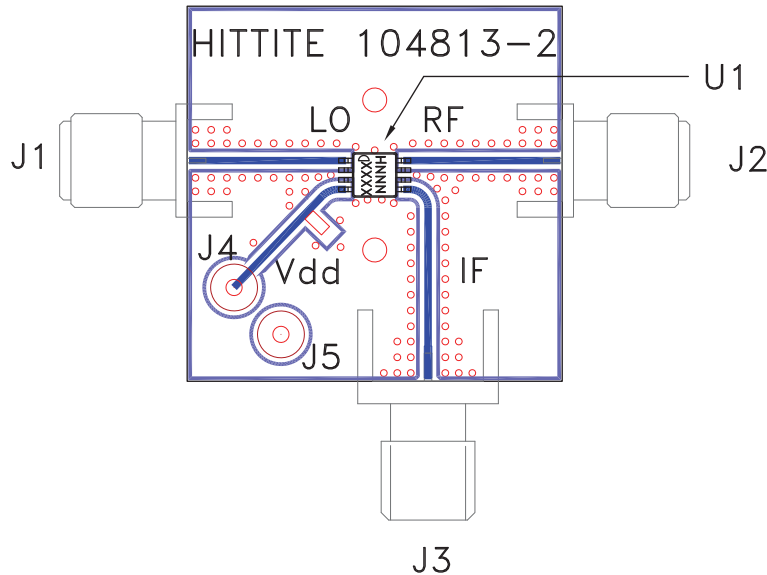

List of Materials for Evaluation PCB 105188 [1]

Item	Description
J1 - J3	PCB Mount SMA RF Connector
J4 - J5	DC Pin
C1	10,000 pF Chip Capacitor, 0603 Pkg.
U1	HMC485MS8G / HMC485MS8GE Mixer
PCB [2]	104813 Evaluation Board, 1.0" x 1.0"

[1] Reference this number when ordering complete evaluation PCB

[2] Circuit Board Material: Rogers 4350

The circuit board used in the final application should use RF circuit design techniques. Signal lines should have 50 ohm impedance while the package ground leads and exposed paddle should be connected directly to the ground plane similar to that shown. A sufficient number of via holes should be used to connect the top and bottom ground planes. The evaluation circuit board shown is available from Hittite upon request.