



Frontier Electronics Corp.

667 E. COCHRAN STREET, SIMI VALLEY, CA 93065

TEL: (805) 522-9998 FAX: (805) 522-9989

E-mail: frontiersales@frontierusa.com

Web: <http://www.frontierusa.com>

2A SUPER FAST RECOVERY SURFACE MOUNT RECTIFIER

SFS2A-LFR THRU SFS2J-LFR

FEATURES

- LOW PROFILE PACKAGE
- PLASTIC PACKAGE HAS UNDERWRITERS LABORATORY 94V-0
- IDEAL FOR SURFACE MOUNTED APPLICATION
- GLASS PASSIVATED CHIP JUNCTION
- BUILT-IN STRAIN RELIEF DESIGN
- SUPER FAST RECOVERY TIME FOR HIGH EFFICIENT
- HIGH TEMPERATURE SOLDERING : 250°C /10 SECONDS AT TERMINAL
- ROHS

MECHANICAL DATA

- CASE: JEDEC DO-214AA MOLDED PLASTIC BODY, DIMENSIONS IN INCHES AND (MILLIMETERS)
- TERMINAL: SOLDER PLATED, SOLDERABLE PER MIL-STD-750 METHOD 2026
- POLARITY: COLOR BAND DENOTES CATHODE
- WEIGHT: 0.093 GRAMS

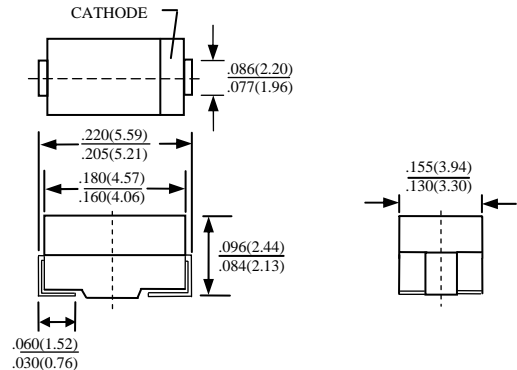

MAXIMUM RATINGS AND ELECTRICAL CHARACTERISTICS RATINGS AT 25°C AMBIENT TEMPERATURE UNLESS OTHERWISE SPECIFIED SINGLE PHASE, HALF WAVE, 60 HZ, RESISTIVE OR INDUCTIVE LOAD. FOR CAPACITIVE LOAD, DERATE CURRENT BY 20%

RATINGS	SYMBOL	SFS2A -LFR	SFS2B -LFR	SFS2D -LFR	SFS2E -LFR	SFS2G -LFR	SFS2G -LFR	SFS2J -LFR	UNITS
MAXIMUM RECURRENT PEAK REVERSE VOLTAGE	V_{RRM}	50	100	200	300	400	500	600	V
MAXIMUM RMS VOLTAGE	V_{RMS}	35	70	140	210	280	350	420	V
MAXIMUM DC BLOCKING VOLTAGE	V_{DC}	50	100	200	300	400	500	600	V
MAXIMUM AVERAGE FORWARD RECTIFIED CURRENT AT $T_J=90^\circ\text{C}$	I_O	2.0							A
PEAK FORWARD SURGE CURRENT, 8.3ms SINGLE HALF SINE-WAVE SUPERIMPOSED ON RATED LOAD	I_{FSM}	50							A
TYPICAL JUNCTION CAPACITANCE (NOTE 1)	C_J	25							PF
TYPICAL THERMAL RESISTANCE (NOTE 2)	$R_{\theta JL}$	20							$^\circ\text{C}/\text{W}$
STORAGE TEMPERATURE RANGE	T_{STG}	- 55 TO + 150							$^\circ\text{C}$
OPERATING TEMPERATURE RANGE	T_{OP}	- 55 TO + 150							$^\circ\text{C}$

ELECTRICAL CHARACTERISTICS ($A_T, T_A = 25^\circ\text{C}$ UNLESS OTHERWISE NOTED)

CHARACTERISTICS	SYMBOL	SFS2A -LFR	SFS2B -LFR	SFS2D -LFR	SFS2E -LFR	SFS2G -LFR	SFS2G -LFR	SFS2J -LFR	UNITS
MAXIMUM FORWARD VOLTAGE AT I_O DC	V_F	0.95			1.25		1.85		V
MAXIMUM REVERSE CURRENT AT 25°C	I_R	10							μA
MAXIMUM REVERSE CURRENT AT 100°C	I_R	100							μA
MAXIMUM REVERSE RECOVERY TIME (NOTE3)	T_{RR}	35							nS
MARKING		SF2A	SF2B	SF2D	SF2E	SF2G	SF2H	SF2J	

NOTE: 1. MEASURED AT 1 MHZ AND APPLIED REVERSE VOLTAGE OF 4.0 VOLTS

2. THERMAL RESISTANCE FROM JUNCTION TO AMBIENT AND JUNCTION TO LEAD P.C.B. MOUNTED ON 0.3x0.3"(8.0x8.0mm) COPPER PAD AREAS

3. REVERSE RECOVERY TEST CONDITIONS: $I_F=0.5\text{A}$, $I_R=1.0\text{A}$, $I_{RR}=0.25\text{A}$

RATINGS AND CHARACTERISTIC CURVE SFS2A-LFR THRU SFS2J-LFR

FIG. 1-TEST CIRCUIT DIAGRAM AND REVERSE RECOVERY TIME CHARACTERISTIC

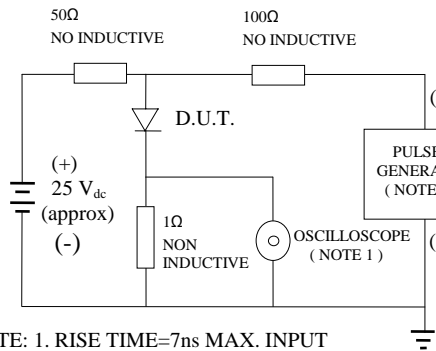

NOTE: 1. RISE TIME=7ns MAX. INPUT IMPEDANCE=1 MOhms 22PF
 2. RISE TIME =10ns MAX. SOURCE IMPEDANCE=50 OHMS

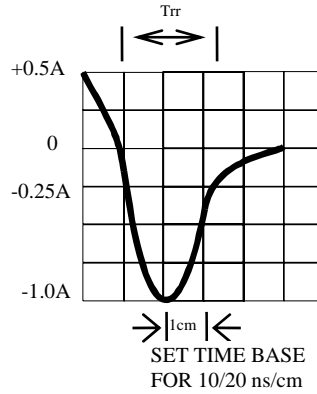

FIG. 2-TYPICAL FORWARD CURRENT DERATING CURVE

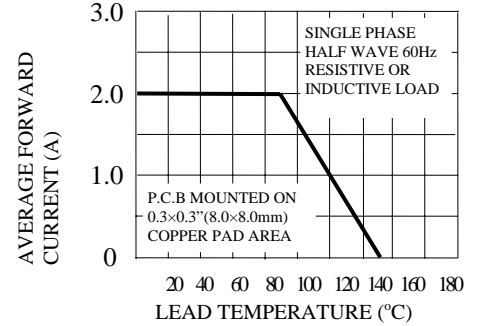

FIG. 3-TYPICAL REVERSE CHARACTERISTICS

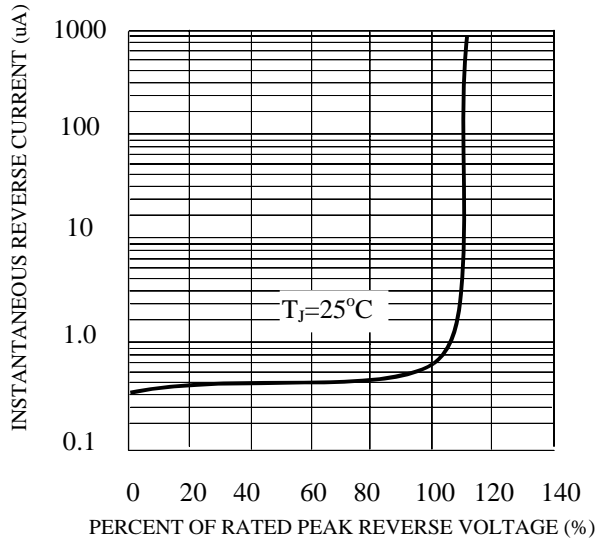

FIG. 4-TYPICAL INSTANTANEOUS FORWARD CHARACTERISTICS

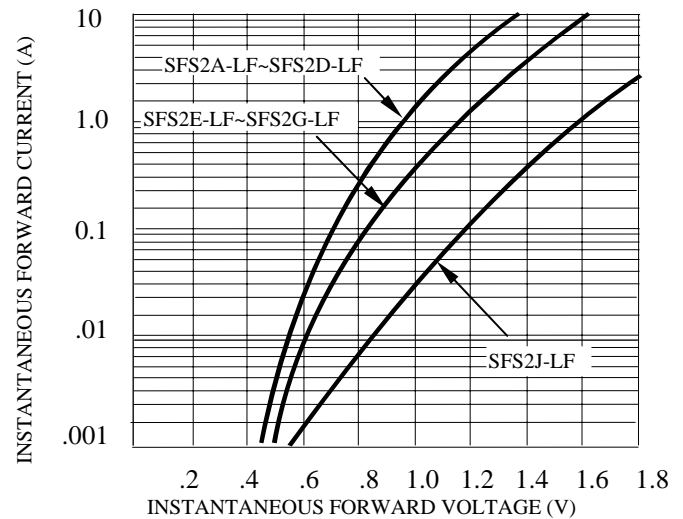

FIG. 5-MAXIMUM NON-REPETITIVE FORWARD SURGE CURRENT

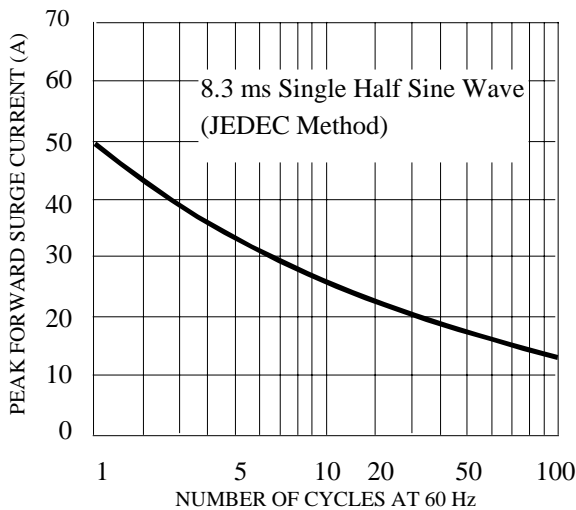

FIG. 6-TYPICAL JUNCTION CAPACITANCE

