

**GaAIAs-IR-Lumineszenzdiode (880 nm)**  
**GaAIAs Infrared Emitter (880 nm)**  
**Lead (Pb) Free Product - RoHS Compliant**

**SFH 486**



**Wesentliche Merkmale**

- GaAIAs-LED mit sehr hohem Wirkungsgrad
- Hohe Zuverlässigkeit
- UL Version erhältlich
- Gute spektrale Anpassung an Si-Fotoempfänger
- Gegurtet lieferbar (im Ammo-Pack)
- Gruppiert lieferbar

**Anwendungen**

- IR-Fernsteuerung von Fernseh- und Rundfunkgeräten, Videorecordern, Lichtdimmern
- Gerätefernsteuerungen für Gleich- und Wechsellichtbetrieb
- Rauchmelder
- Sensorik
- Diskrete Lichtschranken

**Features**

- Very highly efficient GaAIAs-LED
- High reliability
- UL version available
- Spectral match with silicon photodetectors
- Available on tape and reel (in Ammo-pack)
- Available in bins

**Applications**

- IR remote control of hi-fi and TV-sets, video tape recorders, dimmers
- Remote control for steady and varying intensity
- Smoke detectors
- Sensor technology
- Discrete interrupters

Typ Type	Bestellnummer Ordering Code	Gehäuse Package
SFH 486	Q62703Q1094	5-mm-LED-Gehäuse (T 1 <sup>3</sup> / <sub>4</sub> ), klares violette Epoxy-Gießharz, Anschlüsse im 2.54-mm-Raster (1/10"), Anodenkennzeichnung: kürzerer Anschluß 5 mm LED package (T 1 <sup>3</sup> / <sub>4</sub> ), violet-colored epoxy resin, solder tabs lead spacing 2.54 mm (1/10"), anode marking: short lead
SFH 486 E7517 (UL)	Q62703Q6175	

**Grenzwerte** ( $T_A = 25\text{ °C}$ )**Maximum Ratings**

Bezeichnung Parameter	Symbol Symbol	Wert Value	Einheit Unit
Betriebs- und Lagertemperatur Operating and storage temperature range	$T_{op}; T_{stg}$	- 40 ... + 100	°C
Sperrspannung Reverse voltage	$V_R$	5	V
Durchlassstrom Forward current	$I_F$	100	mA
Stoßstrom, $t_p = 10\ \mu\text{s}$ , $D = 0$ Surge current	$I_{FSM}$	2.5	A
Verlustleistung Power dissipation	$P_{tot}$	200	mW
Wärmewiderstand Thermal resistance	$R_{thJA}$	375	K/W

**Kennwerte** ( $T_A = 25\text{ °C}$ )**Characteristics**

Bezeichnung Parameter	Symbol Symbol	Wert Value	Einheit Unit
Wellenlänge der Strahlung Wavelength at peak emission $I_F = 100\text{ mA}$	$\lambda_{peak}$	880	nm
Spektrale Bandbreite bei 50% von $I_{rel}$ Spectral bandwidth at 50% of $I_{rel}$ $I_F = 100\text{ mA}$	$\Delta\lambda$	80	nm
Abstrahlwinkel Half angle	$\varphi$	$\pm 11$	Grad deg.
Aktive Chipfläche Active chip area	$A$	0.09	mm <sup>2</sup>
Abmessungen der aktiven Chipfläche Dimension of the active chip area	$L \times B$ $L \times W$	$0.3 \times 0.3$	mm <sup>2</sup>
Abstand Chipoberfläche bis Gehäusevorderseite Distance chip front to case surface	$H$	5.1 ... 5.7	mm
Schaltzeiten, $I_e$ von 10% auf 90% und von 90% auf 10%, bei $I_F = 100\text{ mA}$ , $R_L = 50\ \Omega$ Switching times, $I_e$ from 10% to 90% and from 90% to 10%, $I_F = 100\text{ mA}$ , $R_L = 50\ \Omega$	$t_r, t_f$	0.6/0.5	$\mu\text{s}$

Kennwerte ( $T_A = 25\text{ °C}$ )

Characteristics (cont'd)

Bezeichnung Parameter	Symbol Symbol	Wert Value	Einheit Unit
Kapazität Capacitance $V_R = 0\text{ V}, f = 1\text{ MHz}$	$C_o$	15	pF
Durchlassspannung Forward voltage $I_F = 100\text{ mA}, t_p = 20\text{ ms}$ $I_F = 1\text{ A}, t_p = 100\text{ }\mu\text{s}$	$V_F$	1.5 (< 1.8) 3.0 (< 3.8)	V
Sperrstrom Reverse current $V_R = 5\text{ V}$	$I_R$	0.01 ( $\leq 1$ )	$\mu\text{A}$
Gesamtstrahlungsfluss Total radiant flux $I_F = 100\text{ mA}, t_p = 20\text{ ms}$	$\Phi_e$	25	mW
Temperaturkoeffizient von $I_e$ bzw. $\Phi_e$ , $I_F = 100\text{ mA}$ Temperature coefficient of $I_e$ or $\Phi_e$ , $I_F = 100\text{ mA}$	$TC_I$	- 0.5	%/K
Temperaturkoeffizient von $V_F$ , $I_F = 100\text{ mA}$ Temperature coefficient of $V_F$ , $I_F = 100\text{ mA}$	$TC_V$	- 2	mV/K
Temperaturkoeffizient von $\lambda$ , $I_F = 100\text{ mA}$ Temperature coefficient of $\lambda$ , $I_F = 100\text{ mA}$	$TC_\lambda$	0.25	nm/K

**Strahlstärke  $I_e$  in Achsrichtung**gemessen bei einem Raumwinkel  $\Omega = 0.001$  sr**Radiant Intensity  $I_e$  in Axial Direction**at a solid angle of  $\Omega = 0.001$  sr

Bezeichnung Parameter	Symbol	Werte Values	Einheit Unit
Strahlstärke Radiant intensity $I_F = 100$ mA, $t_p = 20$ ms	$I_{e \text{ min}}$ $I_{e \text{ typ}}$	40 70	mW/sr
Strahlstärke Radiant intensity $I_F = 1$ A, $t_p = 100$ $\mu$ s	$I_{e \text{ typ}}$	600	mW/sr

**Relative Spectral Emission**

$I_{rel} = f(\lambda)$

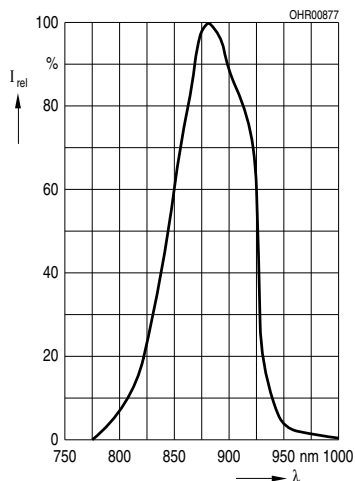

**Radiant Intensity**  $\frac{I_e}{I_e 100 \text{ mA}} = f(I_F)$

Single pulse,  $t_p = 20 \mu\text{s}$

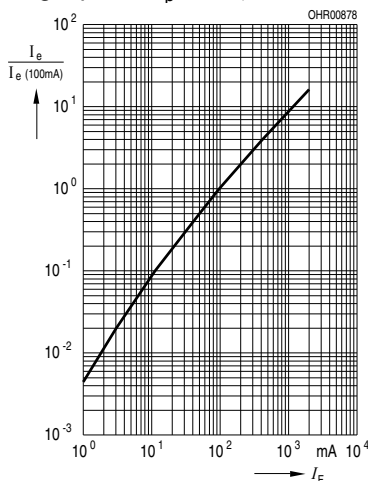

**Max. Permissible Forward Current**

$I_F = f(T_A)$

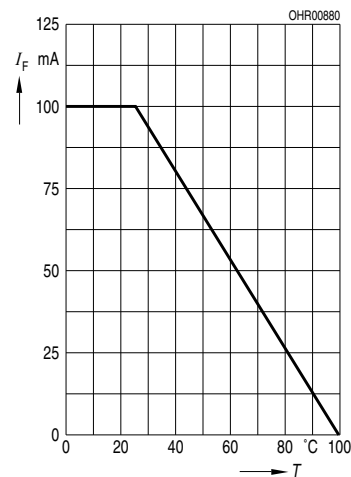

**Forward Current**

$I_F = f(V_F)$ , single pulse,  $t_p = 20 \mu\text{s}$

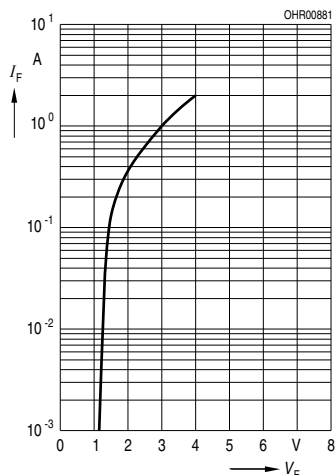

**Permissible Pulse Handling Capability**  $I_F = f(\tau)$ ,  $T_A = 25^\circ\text{C}$ , duty cycle  $D =$  parameter

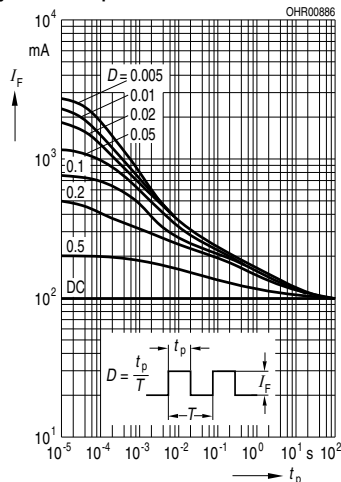

**Forward Current vs. Lead Length** Between the Package Bottom and the PC-Board  $I_F = f(l)$ ,  $T_A = 25^\circ\text{C}$

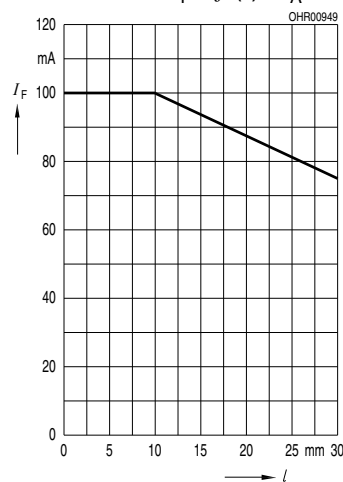

**Radiation Characteristics**  $I_{rel} = f(\varphi)$

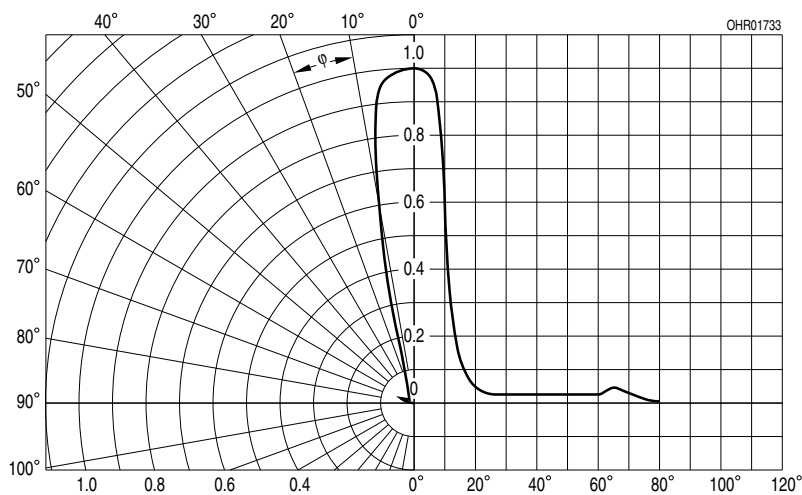

**Maßzeichnung  
Package Outlines**

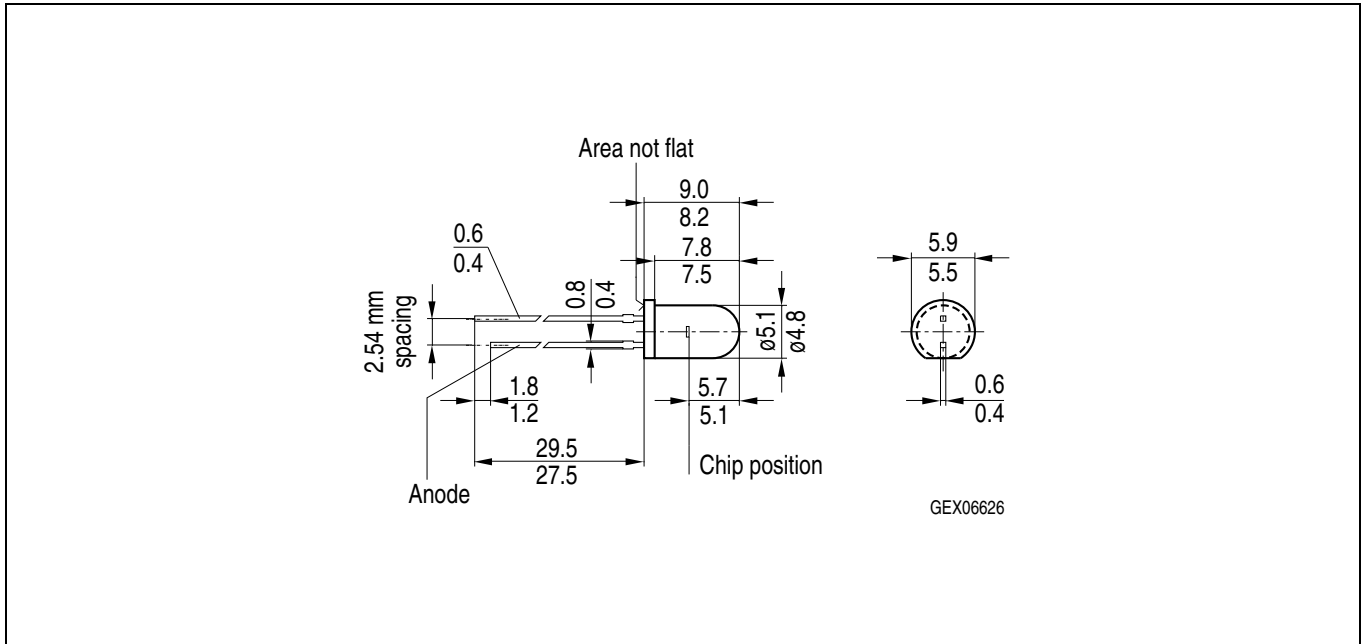

Maße in mm (inch) / Dimensions in mm (inch).

**Empfohlenes Lötpadesign)  
Recommended Solder Pad**

**Wellenlöten (TTW)  
TTW Soldering**

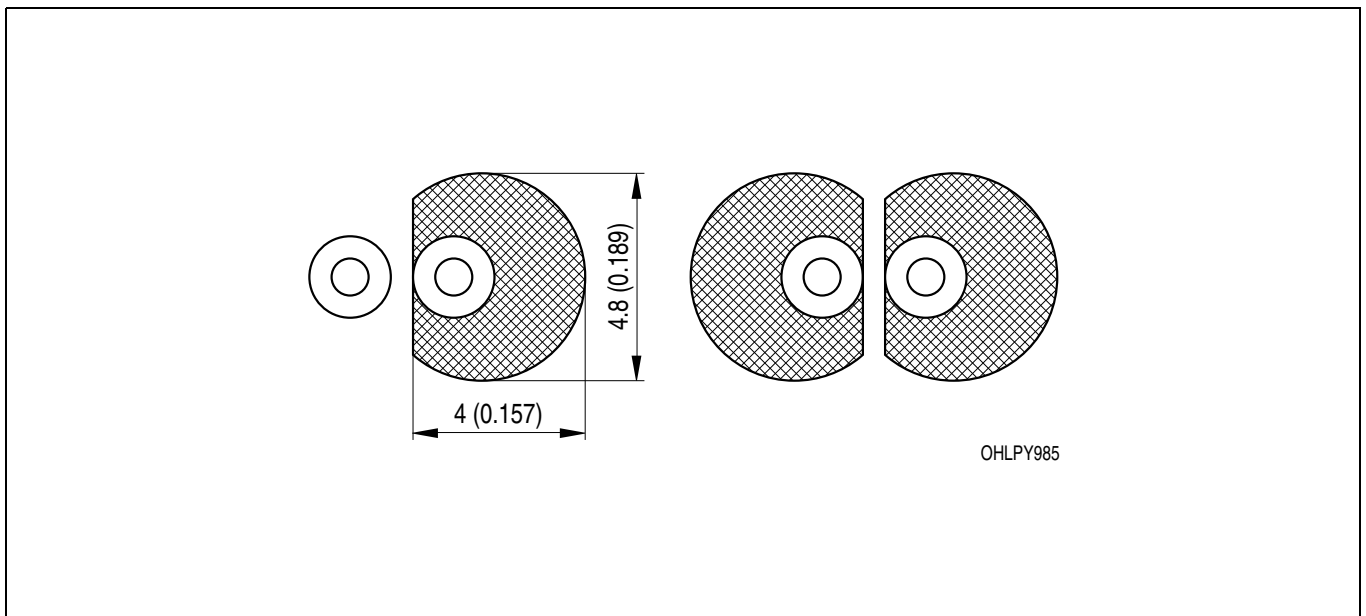

Maße in mm (inch) / Dimensions in mm (inch).

**Lötbedingungen**  
**Soldering Conditions**  
**Wellenlöten (TTW)**  
**TTW Soldering**

(nach CECC 00802)  
(acc. to CECC 00802)

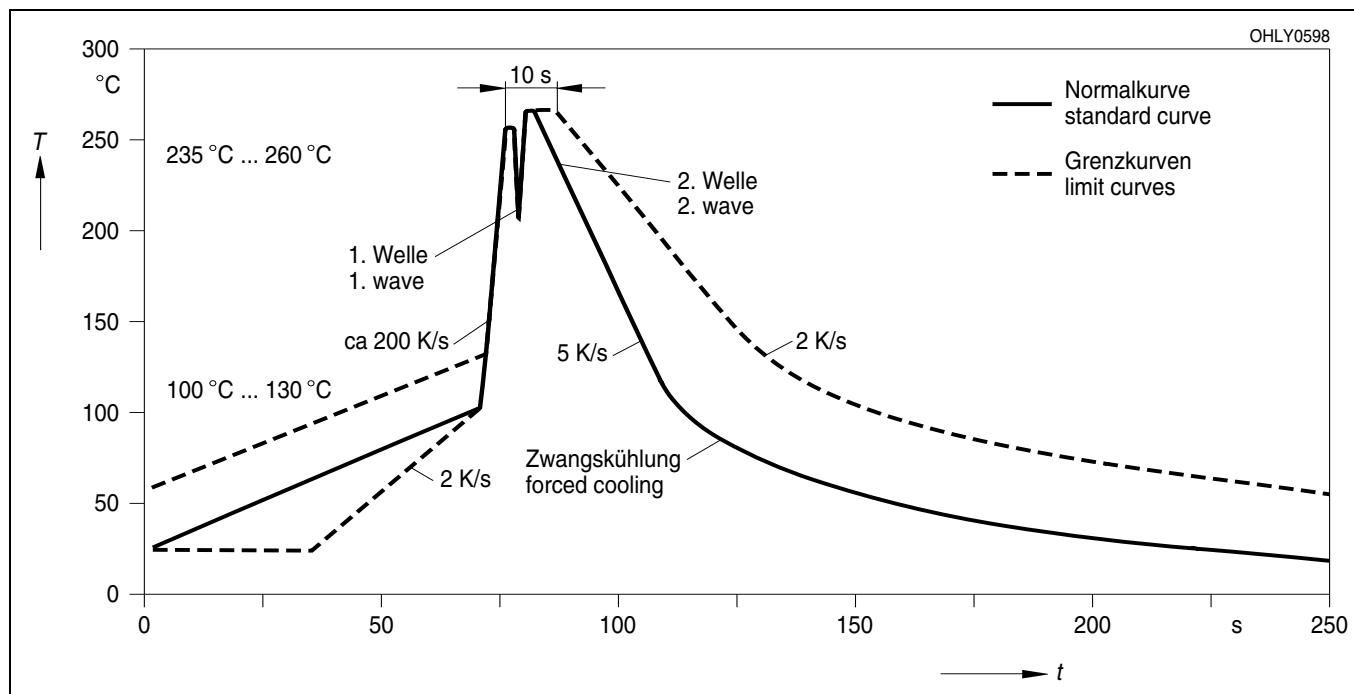

Published by  
**OSRAM Opto Semiconductors GmbH**  
Leibnizstrasse 4, D-93055 Regensburg  
[www.osram-os.com](http://www.osram-os.com)  
© All Rights Reserved.

EU RoHS and China RoHS compliant product



此产品符合欧盟 RoHS 指令的要求；  
按照中国的相关法规和标准，不含有毒有害物质或元素。

The information describes the type of component and shall not be considered as assured characteristics. Terms of delivery and rights to change design reserved. Due to technical requirements components may contain dangerous substances. For information on the types in question please contact our Sales Organization.

**Packing**

Please use the recycling operators known to you. We can also help you – get in touch with your nearest sales office. By agreement we will take packing material back, if it is sorted. You must bear the costs of transport. For packing material that is returned to us unsorted or which we are not obliged to accept, we shall have to invoice you for any costs incurred.

**Components used in life-support devices or systems must be expressly authorized for such purpose!** Critical components<sup>1</sup>, may only be used in life-support devices or systems<sup>2</sup> with the express written approval of OSRAM OS.

<sup>1</sup> A critical component is a component used in a life-support device or system whose failure can reasonably be expected to cause the failure of that life-support device or system, or to affect its safety or effectiveness of that device or system.

<sup>2</sup> Life support devices or systems are intended (a) to be implanted in the human body, or (b) to support and/or maintain and sustain human life. If they fail, it is reasonable to assume that the health of the user may be endangered.

# Mouser Electronics

Related Product Links

[720-SFH486 - Osram Opto Semiconductor SFH 486](#)