

Weidmüller terminal - SAK-series- are proved in millions of applications for more than 50 years.

Available for the two rail systems TS32 and TS35, the SAK terminals are useable for every application and for all cross-sections. SAK terminals fulfill the requirements of EN 60 947-7-1.

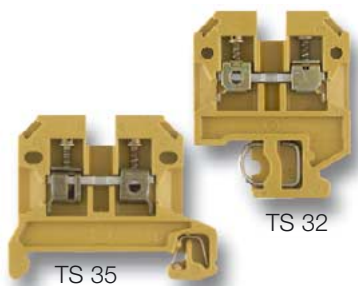

Thermosetting plastic or Thermoplastic

Terminal of thermosetting plastic are normally used in applications where high continuous service temperature and high flammability level are necessary. The Weidmüller thermosetting plastic KRG is very resistant against infection through mould and micro-organisms.

The thermoplastic material Polyamide 66 has very good electrical and mechanical properties upto 100°C. PA66 is flexible and unsusceptible to fracture, even with low temperatures.

Polyamid 66 has improved fire resistance and is self-extinguishing with flammability level V2 according to UL 94.

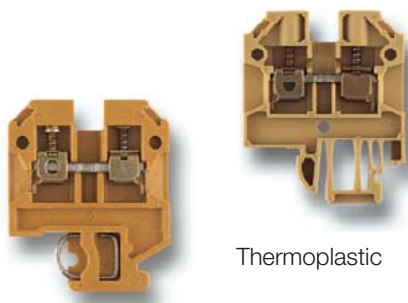

Thermosetting plastic

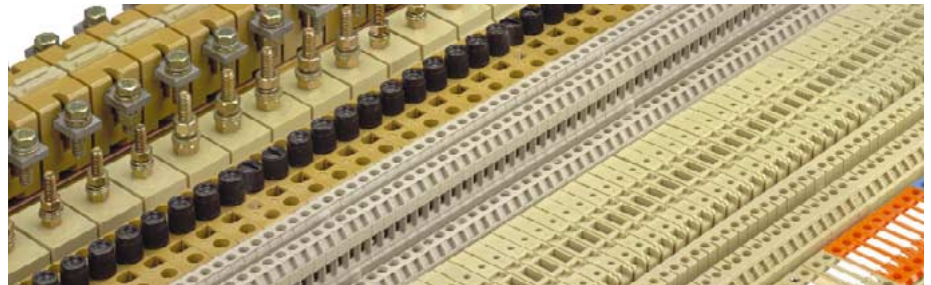

Cross-connection systems

40% of all terminals are cross-connected for potential branching.

Weidmüller distinguishes between the following cross-connection units for SAK-series:

- type Q pre-assembled cross-connections
- type QL permanent cross-connections
- type VL removeable cross-connection straps
- type QS removeable cross-connection plugs

Cross-connection systems from the SAK and AKZ series, type Q, QL or VL or other freely accessible live components, must be protected with appropriate covers ADP 1 or 4 or TSK 31.5 as long as they are to be inserted safe from contact.

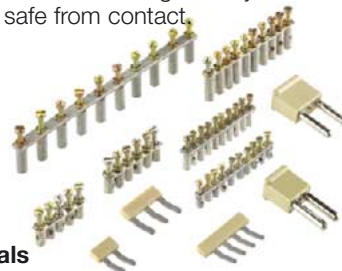

Approvals

The following approvals apply to SAK terminals:

- UL-USA
- CSA-Canada
- GOST-Russia
- SEV-Switzerland
- KEMA-Netherlands
- Lloyds Register of Shipping
- Germanischer Lloyd
- Det Norske Veritas

SAK portfolio

- Feed-through terminals
- Protective conductor terminals
- Fuse terminals
- Disconnect-test terminals
- Feed-through terminals with tab, solder, WireWrap and Termi Point connections
- Initiator terminals, Actuator terminals
- Stud terminals

Accessories



An extensive assortment of accessories is available for Weidmüller SAK terminals:

- Partitions
- Cover plates
- Small partitions
- Test plugs
- Test adapters
- Marking material
- Cross-connections and
- Covers

Positioning of end plates or partitions between cross-connections

Operating voltage	Terminal width (in mm)					
	≤ 6	≤ 8	10	12	18	22
125 V ~	AP	-	-	-	-	-
250 V ~	AP	-	-	-	-	-
380 V ~	AP	AP	-	-	-	-
440 V ~	TW	AP	AP	AP	AP	-
500 V ~	TW	TW	AP	AP	AP	-
660 V ~	TW	TW	TW	TW	TW	AP
750 V ~	TW	TW	TW	TW	TW	AP

In PA terminals small partitions (TSch) have to be used up to 380 V.

Feed-through terminals

SAKD 2.5 N SAKD 2.5/10/35



UL CE LR

SAK 2.5/35 SAK 2.5/10/35



UL CE KEH LR

SAK 2.5 SAK 2.5/10



UL CE KEH LR DNV

SAK 4/35 SAK 4/10/35



UL CE KEH

Dimensions/approvals

Width/length/height (mm)	with TS 32	5/32.5/43.5
Width/length/height (mm)	with TS 35 x 7.5	5/44/38
Insulation stripping length/clamping screw/screwdriver blade		10/M 2.5/3.5 x 0.6

Rated data according to IEC 60 947-7-1

Rated voltage/current/cross-section	500 V/24 A/2.5 mm ²
Rated impulse voltage/pollution severity	6 kV/3

Further technical data

Tightening torque range	Nm	0.4...0.6
Torque setting with electric screwdriver type DMS 2		1

Clampable conductor

Solid H07V-U	mm ²	0.5...4
Stranded H07V-R	mm ²	0.5...2.5
Flexible H07V-K	mm ²	0.5...4
Flexible H07V-K and ferrule according to DIN 46 228/1	mm ²	0.5...2.5
Plug gauge according to 60 947-7-1	Size	A 2
Continuous current of terminal for conductor size		30 A/4 mm ²
Continuous current rating of cross-connection 2...5-pole	A	24
Continuous current rating of cross-connection 6...10-pole	A	24

Rated data according to UL/CSA

Voltage/current/conductor size	UL	300 V/20 A/28...12 AWG
Voltage/current/conductor size	CSA	300 V/20 A/22...12 AWG

Ordering data

Version	Qty.	Qty.
KrG		
Blue KrG		
KrS		
PA	0215560000	0268860000
Blue PA	0215580000	0268880000
Orange PA		
Terminal block with marking PA	0401060000	0523160000
Terminal block without marking PA	0401160000	10

End plate (thickness mm)



Type	Cat. No.	Qty.
KrG		
Blue KrG		
KrS		
PA	AP (1.5)	0150960000 20
Blue PA	AP (1.5)	0150980000 20
PA		
Blue PA		

Partition (thickness mm)



Type	Cat. No.	Qty.
KrG		
Blue KrG		
KrS		
PA	TW (1.5)	0191860000 20
Blue PA	TW (1.5)	0191880000 20
HP	TW (1.5)	0307500000 20

Small partition

TSch 1

TSch 3	0366860000	100
--------	------------	-----

Cross-connection

Q 4	2-pole	Q 2	0367800000	50
	3-pole	Q 3	0367900000	50
	4-pole	Q 4	0368000000	50
	10-pole	Q 10	0368100000	20

Cover plates

AD 4	0303400000	50
BSKM3x22	0128900000	100

Switchable cross-connection link



VL 2	0197000000	100
VH	0285100000	50
BS	0292500000	100

Marking tags

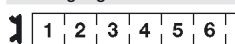

DEK 5	see "Accessories"
DEK 6	see "Accessories"
DEK 6.5	see "Accessories"

Mounting rails, end brackets, further marking material see "Accessories"

¹⁾ Contact-proof with ADP 4 cover profile (see section "Accessories")
²⁾ Not suitable for SST 3 safety pin

³⁾ Cat. No. 0279660000, 0279680000, 0380460000 and 0380480000, 41 A for 6 mm²

Feed-through terminals

SAK 4 SAK 4/10

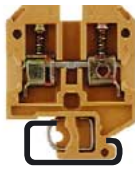

DK 4 Q* DKB4 Q*/10*



DK 4 DK4/35

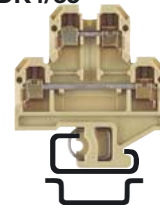

Dimensions/approvals

Width/length/height (mm)	with TS 32	
Width/length/height (mm)	with TS 35 x 7.5	
Insulation stripping length/clamping screw/screwdriver blade		

Rated data according to IEC 60 947-7-1

Rated voltage/current/cross-section	800 V/32 A/4 mm ²
Rated impulse voltage/pollution severity	8 kV/3

Further technical data

Tightening torque range	Nm	0.5...1.0
Torque setting with electric screwdriver type DMS 2		2

Clampable conductor

Solid H07V-U	mm ²	0.5...6
Stranded H07V-R	mm ²	0.5...4
Flexible H07V-K	mm ²	0.5...4
Flexible H07V-K and ferrule according to DIN 46 228/1	mm ²	
With/without plastic insulating collar	mm ²	0.5...4
Plug gauge according to 60 947-7-1	Size	A 4
Continuous current of terminal for conductor size		41 A/6 mm ²
Continuous current rating of cross-connection 2...5-pole	A	36
Continuous current rating of cross-connection 6...10-pole	A	

Technical data

Voltage/current/conductor size	UL	600 V/20 A/22...12 AWG
Voltage/current/conductor size	CSA	600 V/36 A/26...10 AWG

Ordering data

Version	Cat. No.	Qty.
KrG	0128320000	100
Blue KrG	0128370000	100
KrS	0128330000	100
PA	0128360000 ¹⁾²⁾	100
Blue PA	0128380000 ¹⁾²⁾	100
Orange PA	0105060000 ¹⁾²⁾	100
Terminal block with marking PA	0322660000 ¹⁾²⁾	10
Terminal block without marking PA	0308860000 ¹⁾²⁾	10

End plate (thickness mm)

Type	Cat. No.	Qty.
KrG	AP (1.5) 0117920000	20
Blue KrG	AP (1.5) 0117970000	20
KrS	AP (1.5) 0117930000	20
PA	AP (1.5) 0117960000	20
Blue PA	AP (1.5) 0117980000	20
PA		
Blue PA		

Partition (thickness mm)

Type	Cat. No.	Qty.
KrG	TW (2.5) 0130120000	20
Blue KrG	TW (2.5) 0103170000	20
KrS	TW (2.5) 0130130000	20
PA	TW (1.5) 0130160000	20
Blue PA	TW (1.5) 0130180000	20
HP	TW (1.0) 0197100000	20

Small partition

TSch 6	TSch 1	0319160000	100
--------	--------	-------------------	-----

Cross-connection

Type	Cat. No.	Qty.
Q 2	0336700000	50
Q 3	0336800000	50
Q 4	0336900000	50
Q 10	0368800000	20
QB 2	0482700000 **	100
QB 3	0482800000 **	50
QB 4	0482900000 **	50

Switchable cross-connection link

VL 2	VL 2	0197000000	100
BS	VH	0285100000	50
	BS	0292500000	100

Marking tags

DEK	Standard	DEK6.5	see "Accessories"
-----	----------	--------	-------------------

Mounting rails, end brackets, further marking material see "Accessories"

* Accepts LS 2.8 shield lugs Cat. No. **1056400000**

** 2.5 mm² conductor connection when using QB

UL LR DNV

6.5/40/51.5

UL

6/54/60

6/54/60.5

9/M 3/3.5 x 0.6

500 V/2 x 32 A/4 mm²

6 kV/3

0.5...1.0

2

0.5...4

0.5...4

0.5...4

0.5...4

0.5...4

32 A/4 mm²

32

32

32

300 V/27 A/22...12 AWG

300 V/10 A/26...12 AWG

0590060000¹⁾ 100 0590160000¹⁾ 100

0590080000¹⁾ 100 0590180000¹⁾ 100

1323860000¹⁾ 10

0355460000¹⁰⁰ 0527660000¹⁰⁰

0355480000¹⁰⁰ 0527680000¹⁰⁰

AP (1.5) **1397160000** 20

AP (1.5) **1397180000** 20

WTW (Ex) **1058800000** 20

WTW (Ex) **1058800000** 20

TSch 6 **0190260000** 100

TSch 6 **0190260000** 100

Q 2 **0336400000** 50

Q 3 **0336500000** 50

Q 4 **0336600000** 50

Q 10 **0368600000** 20

QB 2 **0482700000**** 100

QB 3 **0482800000**** 50

QB 4 **0482900000**** 50

VL 2 **0446700000** 50

VH **1056500000** 100

BS **0343100000** 100

DEK6 see "Accessories"

DEK6 see "Accessories"

DEK6 see "Accessories"

Feed-through terminals

DK4 QV* DK4 QV/35*



UL

SAK 6 N SAK 6/10/35



UL LR DNV

SAK 10 SAK 10/10/35



UL LR DNV

SAK 16 SAK 16/35



UL LR DNV

Dimensions/approvals

Width/length/height (mm)	with TS 32	6/54/60
Width/length/height (mm)	with TS 35 x 7.5	6/54/60.5
Insulation stripping length/clamping screw/screwdriver blade		9 mm/M 3/3.5 x 0.6

Rated data according to IEC 60 947-7-1

Rated voltage/current/cross-section	500 V/32 A/4 mm ²
Rated impulse voltage/pollution severity	6 kV/3

Further technical data

Tightening torque range	Nm	0.5...1.0
Torque setting with electric screwdriver type DMS 2		2

Clampable conductor

Solid H07V-U	mm ²	0.5...4
Stranded H07V-R	mm ²	0.5...4
Flexible H07V-K	mm ²	0.5...4
Flexible H07V-K and ferrule according to DIN 46 228/1	mm ²	
With/without plastic insulating collar	mm ²	0.5...4
Plug gauge according to 60 947-7-1	Size	A 3
Continuous current of terminal for conductor size		32 A/4 mm ²
Continuous current rating of cross-connection 2...5-pole	A	32
Continuous current rating of cross-connection 6...10-pole	A	32

Rated data according to UL/CSA

Voltage/current/conductor size	UL	300 V/27 A/22...12 AWG
Voltage/current/conductor size	CSA	300 V/10 A/26...12 AWG

Ordering data

Version	Qty.
KrG	
Blue KrG	
KrS	
PA	
Blue PA	
Orange PA	
Terminal block with marking	
Terminal block without marking	

Type	Cat. No.	Qty.
AP	0117920000	20
AP (1.5)	0117970000	20
AP (1.5)	0117930000	20
AP (1.5)	0117960000	20
AP (1.5)	0117980000	20
TW	0130120000	20
TW (1.5)	0130130000	20
TW (1.5)	0130160000	20
TW (1.5)	0130180000	20
TW (1.5)	0197100000	20
TSch 1	0319160000	100
Q 2	0456700000	50
Q 3	0456800000	50
Q 4	0456900000	50
Q 10	0457000000	20
QB 2	0482700000**	100
QB 3	0482800000**	50
QB 4	0482900000**	50

Type	Cat. No.	Qty.
AP	0117920000	20
AP (1.5)	0117970000	20
AP (1.5)	0117930000	20
AP (1.5)	0117960000	20
AP (1.5)	0117980000	20
TW	0130120000	20
TW (1.5)	0130130000	20
TW (1.5)	0130160000	20
TW (1.5)	0130180000	20
TW (1.5)	0197100000	20
TSch 1	0319160000	100
Q 2	0456700000	50
Q 3	0456800000	50
Q 4	0456900000	50
Q 10	0457000000	20
QB 2	0482700000**	100
QB 3	0482800000**	50
QB 4	0482900000**	50

Type	Cat. No.	Qty.
AP	0117920000	20
AP (1.5)	0117970000	20
AP (1.5)	0117930000	20
AP (1.5)	0117960000	20
AP (1.5)	0117980000	20
TW	0130120000	20
TW (1.5)	0130130000	20
TW (1.5)	0130160000	20
TW (1.5)	0130180000	20
TW (1.5)	0197100000	20
TSch 1	0319160000	100
Q 2	0457100000	50
Q 3	0457200000	50
Q 4	0457300000	50
Q 10	0457400000	20
QB 2	0482700000**	100
QB 3	0482800000**	50
QB 4	0482900000**	50

Type	Cat. No.	Qty.
AP	0271120000	20
AP (3.0)	0271130000	20
AP (1.5)	0271160000	20
AP (1.5)	0271180000	20
TW	0281120000	20
TW (3.0)	0281130000	20
TW (1.5)	0303660000	10
TW (1.5)	0303680000	10
TW (2.0)	0607000000	20
TSch 1	0319160000	100
Q 2	0457500000	50
Q 3	0457600000	50
Q 4	0457700000	50
Q 10	0457800000	20
QB 2	0482700000**	100
QB 3	0482800000**	50
QB 4	0482900000**	50

End plate (thickness mm)

AP	KrG	
	Blue KrG	
	KrS	
	PA	
	Blue PA	

Partition (thickness mm)

TW	KrG	
	Blue KrG	
	KrS	
	PA	
	Blue PA	
	TSch 6	
WTW		
Small partition		

Cross-connection

Q 4	2-pole	Q 2	0336400000	50
	3-pole	Q 3	0336500000	50
	4-pole	Q 4	0336600000	50
	10-pole	Q 10	0368600000	20
		QB 2	0482700000**	100
		QB 3	0482800000**	50
		QB 4	0482900000**	50

Cover

AD 4	0303400000	50
BSK M 2.5 x18	0303300000	100

AD 4	0196600000	50
BSKM3x22	0128900000	100

AD 4	0178600000	50
BSKM3x22	0128900000	100

AD 4	0518200000	50
BSKM3x22	0128900000	100

Switchable cross-connection link

VL 2	VL 2	0446700000	50
BS	VH	1056500000	100
VH	BS	0343100000	100

VL 2	VL 2	0194700000	50
VH	VH	0285100000	50
BS	BS	0292500000	100

VL 2	VL 2	0135900000	50
VH	VH	0285100000	50
BS	BS	0292500000	100

VL 2	VL 2	0135800000	50
VH	VH	0285100000	50
BS	BS	0292500000	100

Marking tags

1	2	3	4	5	6	DEK	Standard
---	---	---	---	---	---	-----	----------

DEK 6	see "Accessories"
-------	-------------------

DEK 8	see "Accessories"
-------	-------------------

DEK 5	see "Accessories"
-------	-------------------

DEK 5	see "Accessories"
-------	-------------------

Mounting rails, end brackets, further marking material see "Accessories"

* Accepts LS 2.8 shield lugs Cat. No. 1056400000
** 2.5 mm² conductor connection when using QB

1) Contact-proof with ADP 4 cover profile (see section "Accessories")

2) Tightening torque for 16 mm² stranded: 2 Nm

3) Tightening torque for 16 mm² and AWG6: 2 Nm

Feed-through terminals (spring-loaded)

RSF 3 RSF 3/35



RSF 1



RSF 2

Disconnect test terminal

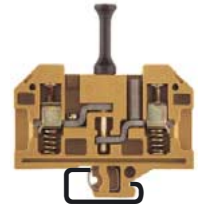

Dimensions/approvals		☉	☉	☉	☉				
Width/length/height (mm)	with TS 32	8/50/60	11/50/60		11/77/72.5				
Width/length/height (mm)	with TS 35 x 7.5	8/50/53							
Insulation stripping length/clamping screw/screwdriver blade		12 mm	12 mm		12 mm				
Rated data									
Rated voltage/-current		630 V/32 A	500 V/57 A		500/41 A				
Rated cross-section	mm ²	4	10		6				
Rated impulse voltage VDE 0110/1.89/pollution severity		6 kV/3	6 kV /3		6 kV/3				
Further technical data									
Tightening torque range	Nm	0.5...1.0							
Torque setting with electric screwdriver type DMS 2		2							
Clampable conductor									
Solid H07V-U	mm ²	0.5...4	0.5...10		0.75...16				
Stranded H07V-R	mm ²	0.5...4	0.5...10		0.75...10				
Rated data according to UL/CSA									
Voltage/current/conductor size	UL								
Voltage/current/conductor size	CSA								
Ordering data		Version	☉ Qty.	☉ Qty.	☉ Qty.				
		PA	0497560000 50	9501160000 50					
		KrG	0497520000 50	0270320000 50	0623320000*20 0623120000**20				
End plate/partition/small partition		Type	Cat. No.	Qty.	Type	Cat. No.	Qty.		
AP	TW	TSch 1	PA	AP (3)	0270460000	10	AP (3.0)	0301420000	10
			KrG	TW (1.5)	3877960000	10	PA		
			HP	TW (2)	3833500000	20	HP		
			HP	TW (0.5)	0474700000	20	HP		
			PA	TSch 1	0319160000	100	PA		
Cross-connection		QL	VH	SS	2-pole	3-pole	4-pole	10-pole	
			QL 2	0194300000	50	QL 3	0194400000	50	
			QL 3	0194400000	50	QL 4	0194500000	50	
			QL 4	0194500000	50	QL 10	0338300000	10	
			QL 10	0338300000	10	VH 13.5	0248500000	100	
			VH 13.5	0248500000	100	VH 17.5	0285200000	50	
			VH 17.5	0285200000	50				
BS M 3 x ...			BS M 3x20	0303000000	100	BS M 3x25	0292500000	100	
			SS	0164400000	50	SS	0164400000	50	
			QS 4	0369760000	10	QS 4	0369760000	10	
Switchable cross-connection link		VH 21	VH 27	BS M 3x20	SS	VH 2	VH 21	BS M 3x20	SS
			VH 2	0194700000	50	VH 2	0528400000	50	
			VH 21	0309600000	100	VH 21	0309400000	50	
			BS M 3x20	0296200000	50	BS M 3x25	0309800000	50	
			SS	0164400000	50	SS	0164400000	50	
Dummy plug		PS	StB	BST 1					
	made from plastic, to keep the place of an extracted plug	PS 2.3	0180400000	50	BST 1	3878060000	20		
		StB 14	0168600000	50					
Test plug/socket		PS	StB	PS 4	StB 17				
		PS 2.4	0299600000	20	PS 4	0299600000	20		
		StB 18	0286500000	20	StB 17	0147100000	50		
Cover plate		ADP 2	ADP 2						
		ADP 2	0485300000	1	ADP 2	0485300000	1		
Marking tags		Print	DEK	DEK					
	Standard	DEK	see "Accessories"	DEK	see "Accessories"				

* with disconnecter (73 mm height)

** Disconnecter with handle (86 mm height)

Feed-through terminals for thermocouples

Busbars made from thermocouple materials according to DIN IEC 584

SAK 2.5 TC

DK 4 Q/TC

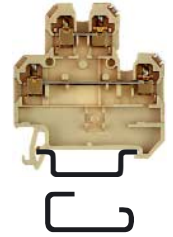

Weidmüller's **thermocouple-terminals** are specially designed for transmitting the smallest voltages in temperature measuring circuits. Special busbars ensure that no false signals occur in the terminal when temperature differences exist in the positive and negative path.

This high measuring precision is necessary for, e.g. test beds, air craft engines, for complicated chemical processes, controls, etc.

I. Configuration of a temperature measuring circuit

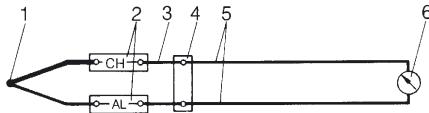

- 1 Thermocouple (sensor)
- 2 Thermocouple terminals
- 3 Compensation conductor
- 4 Reference point
- 5 Supply conductors (to and from)
- 6 Measuring device

The thermocouple terminals displayed in this measurement circuit are used to thermoelectrically transmit thermal e.m.f. of the thermocouple to the reference point and indicating device via the thermocouple.

II. Symbols Thermocouples according to IEC 584 DIN 43710

Terminal	Busbar material trade name
a) Type J	
Fe (positive leg)	Iron
CuNi (negative leg)	Constantan
b) Type T	
Cu (positive leg)	Copper
CuNi (negative leg)	Constantan
c) Type K	
NiCr (positive leg)	Chromel
Ni (negative leg)	Alumel

Dimensions/approvals		SAK 2.5 TC	DK 4 Q/TC
Width/length/height (mm)	with TS 32	6/36.5/49.5	6/54/59.5
Width/length/height (mm)	with TS 35 x 7.5		6/54/60.5
Insulation stripping length/clamping screw/screwdriver blade		10 mm/M 2.5/3.5 x 0.6	9 mm/M 3/3.5 x 0.6
Technical data/VDE			
Rated voltage/current/cross-section		-/-/2.5 mm ²	-/-/4 mm ²
Tightening torque range	Nm	0.4...0.6	0.5...1

Ordering data	Version	Type	Cat. No.	Qty.
	NiCr		0107260000	100
	Ni		0107160000	100
	CuNi		0189860000	100
	Fe		0190060000	100
	Cu		0189960000	100
	NiCr/Ni	K	1284160000	1338260000
	Cu/CuNi	T	1285660000	1338160000
	Fe/CuNi	J	1284060000	1338060000

End plate (thickness mm)	Type	Cat. No.	Qty.
	KrG		
	Blue KrG		
	KrS		
	PA	AP (1.5)	0279560000 20
	Blue PA		
	Orange PA		

Partition (thickness mm)	Type	Cat. No.	Qty.
	KrG		
	Blue KrG		
	KrS		
	PA	TW (1.5)	0302860000 20
	WEM		
	for TS 32 HP		

Marking tags	Print
1 2 3 4 5 6	DEK Standard DEK 6 see "Accessories"
	DEK 6 see "Accessories"

Mounting rails, end brackets, further marking material see "Accessories"

SAK-series

Feed-through terminals

Terminals/Accessories

SAKG 28 I

SAKG 28 II



The Weidmüller SAKG range offers the following connection variants:

- clamping yoke/flat lug as a combination, Version I.
- flat lug, Version II.
Two types of threading are provided here.
a) screw set with lock nut
b) with thread in busbar
- clamping yoke connection, Version III.
The stripped conductor can be connected without further preparation.

Versions

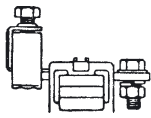

Version I

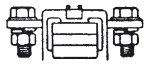

Version II

without thread



Version II G

with thread

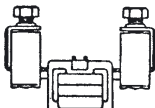

Version III

Cables with cable lugs are connected to SAKG terminals of Version I and to SS stud terminals.

Fitting instructions for SAKG terminals

When tightening the clamping screw, it is recommended that the conductor be held against the direction of tightening to prevent deformation of the mounting rail and so as not to place the terminal foot under undue torsional forces.

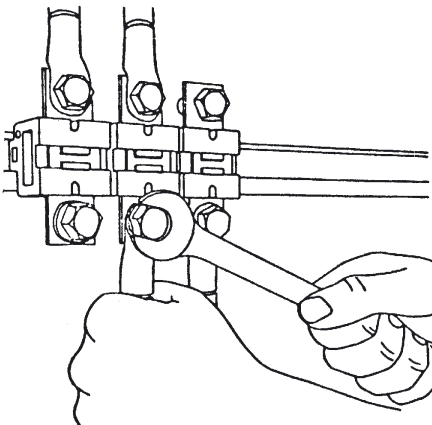

Cover

To ensure shock protection following connections of **conductors**, AH covers can be clipped onto the terminal.

Dimensions/approvals

Width/length/height (mm)	with TS 32	
Width/length/height (mm)	with TS 35	
Insulation stripping length/clamping screw/screwdriver blade		

Rated data according to IEC 60 947-7-1

Rated voltage/current/cross-section	1000 V*/125 A/35 mm ²
Rated impulse voltage/pollution severity	8 kV/3

Further technical data

Tightening torque range	Nm	3...6
Torque setting with electric screwdriver type DMS 2		

Clampable conductor

Solid H07V-U	mm ²	6...35
Stranded H07V-R	mm ²	6...35
Flexible H07V-K	mm ²	10...35
Flexible H07V-K and ferrule according to DIN 46 228/1	mm ²	6...35
Plug gauge according to 60 947-7-1	Size	B 9
Continuous current of terminal for conductor size		125 A/35 mm ²
Continuous current rating of cross-connection 2...5-pole	A	(QL 2) 125
Continuous current rating of cross-connection 6...10-pole	A	(QL 2) 125

Rated data according to UL/CSA

Voltage/current/conductor size	UL	600 V/95 A/2 AWG
Voltage/current/conductor size	CSA	600 V/110 A/6...1 AWG

Ordering data

Type		Cat. No.	Qty.
KrG		0170020000	10

UL @

28/70/63.5

15 mm/M 6/-

1000 V*/125 A/35 mm²

8 kV/3

3...6

6...35

6...35

10...35

6...35

B 9

125 A/35 mm²

(QL 2) 125

600 V/95 A/2 AWG

600 V/110 A/6...1 AWG

Cat. No.

Qty.

0170020000 10

UL @ DNV

28/70/53

-/M 6/-

1000 V*/125 A/35 mm²

8 kV/3

3...6

125 A/35 mm²

(QL 2) 125

600 V/115 A/2 AWG

600 V/110 A/6...1 AWG

Cat. No.

Qty.

0170320000 10

End plate, hard paper

	Cat. No.	Qty.
	EP 1 (2)	0205100000 10
	EP 1 (2)	0205200000 10



0180700000, 0205300000

0180800000, 0205400000 tropic-proof



Partition, hard paper (thickness in mm)

	Cat. No.	Qty.
	TW 1 (2)	0151400000 10
	TW 1 (2)	0164600000 10



0177100000 B/L/H (incl. TS 32) mm

0179900000 B/L/H (incl. TS 35) mm



Cross-connection

	2-pole	QL 2	0193900000 5
	3-pole	QL 3	0407600000 5
	4-pole	QL 4	0407700000 5



Cover

AH 28 **0326660000** 5



Marking tags

	1	2	3	4	5	6	DEK	Standard
							DEK 5	see "Accessories"

Mounting rails, end brackets, further marking material see "Accessories"

During conductor connection, observe clearance and creepage distances. Insert partitions if necessary.

Feed-through terminals

SAKG 28 II G



28/70/53
-/M 6/-
1000 V*/125 A/35 mm ²
8 kV/3
3...6
125 A/35 mm ²
(QL 2) 125

	Cat. No.	Qty.
	0185020000	10

	Cat. No.	Qty.
EP 1 (2)	0205100000	10
EP 1 (2)	0205200000	10

	Cat. No.	Qty.

	Qty.
TW 1 (2)	0151400000 10
TW 1 (2)	0164600000 10

2/120/75.5

QL 2	0193900000	5
QL 3	0407600000	5
QL 4	0407700000	5

AH 28	0326660000	5
-------	-------------------	---

DEK 5	see "Accessories"
-------	-------------------

SAKG 28 III



28/70/63.5
15 mm/M 6/-
1000 V*/125 A/35 mm ²
8 kV/3
3...6
B 9

600 V/95 A/2 AWG		
600 V/135 A/8...2 AWG		
	Cat. No.	Qty.
	0170820000	10

	Cat. No.	Qty.
EP 1 (2)	0205100000	10
EP 1 (2)	0205200000	10

	Cat. No.	Qty.

	Qty.
TW 1 (2)	0151400000 10
TW 1 (2)	0164600000 10

2/120/75.5

AH 28	0326660000	5
-------	-------------------	---

DEK 5	see "Accessories"
-------	-------------------

SAKG 32 I SAKG 32/35 I



32/87/84
32/87/84.5
26 mm/M 8/-
1000 V*/150 A/50 mm ²
8 kV/3
6...12
10...70
10...70
10...70
10...35
B 11
150 A/50 mm ²
(QL 2) 150

600 V/165 A/3 AWG				
600 V/170 A/1...2/0 AWG				
	Qty.		Qty.	
	0286620000		0637120000	10

	Cat. No.	Qty.
EP 1 (2)	0205300000	10
EP 1 (2)	0205400000	10

	Cat. No.	Qty.
EP 2/35 (2)	0180700000	10
EP 2/35 (2)	0180800000	10

	Qty.
TW 2 (2)	0177100000 10
TW 2 (2)	0179900000 10

2/160/90.5
2/160/90.5

QL 2	0194000000	5
QL 3	0441500000	5
QL 4	0441600000	5

AH 32	0326760000	5
-------	-------------------	---

DEK 5	see "Accessories"
-------	-------------------

SAKG 32 II SAKG 32/35 II



32/80/53
32/80/51
-/M 8/-
1000 V*/150 A/50 mm ²
8 kV/3
6...12
150 A/50 mm ²
(QL 2) 150

600 V/200 A/3 AWG				
600 V/170 A/1...2/0 AWG				
	Qty.		Qty.	
	0170420000		0637320000	10

	Cat. No.	Qty.
EP 1 (2)	0205100000	10
EP 1 (2)	0205200000	10

	Cat. No.	Qty.
EP 1/35 (2)	0180700000	10
EP 1/35 (2)	0180600000	10

	Qty.
TW 1 (2)	0151400000 10
TW 1 (2)	0164600000 10

2/120**/75.5
2/120**/75.5

QL 2	0194000000	5
QL 3	0441500000	5
QL 4	0441600000	5

AH 32	0326760000	5
-------	-------------------	---

DEK 5	see "Accessories"
-------	-------------------

SAKG 32 II G SAKG 32/35 II G



	DNV
32/80/53	
32/80/53	
-/M 8/-	
1000 V*/150 A/50 mm ²	
8 kV/3	
6...12	
150 A/50 mm ²	
(QL 2) 150	

600 V/170 A/1...2/0 AWG				
	Qty.		Qty.	
	0185120000		0637420000	10

	Cat. No.	Qty.
EP 1 (2)	0205100000	10
EP 1 (2)	0205200000	10

	Cat. No.	Qty.
EP 1/35 (2)	0180700000	10
EP 1/35 (2)	0180600000	10

	Qty.
TW 1 (2)	0151400000 10
TW 1 (2)	0164600000 10

2/120**/75.5
2/120**/75.5

QL 2	0194000000	5
QL 3	0441500000	5
QL 4	0441600000	5

AH 32	0326760000	5
-------	-------------------	---

DEK 5	see "Accessories"
-------	-------------------

SAKG 32 III SAKG 32/35 III

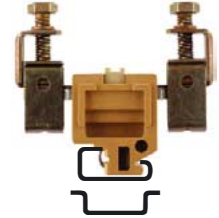

32/94/84
32/94/84.5
26 mm/M 8/-
1000 V*/150 A/50 mm ²
8 kV/3
6...12
10...70
10...70
10...70
10...35
B 11
150 A/50 mm ²

600 V/165 A/3 AWG				
600 V/185 A/1...2/0 AWG				
	Qty.		Qty.	
	0286720000		0637220000	10

	Cat. No.	Qty.
EP 2 (2)	0205300000	10
EP 2 (2)	0205400000	10

	Cat. No.	Qty.
EP 2/35 (2)	0180700000	10
EP 2/35 (2)	0180800000	10

	Qty.
TW 2 (2)	0177100000 10
TW 2 (2)	0179900000 10

2/160/90.5
2/160/90.5

QL 2	0194000000	5
QL 3	0441500000	5
QL 4	0441600000	5

AH 32	0326760000	5
-------	-------------------	---

DEK 5	see "Accessories"
-------	-------------------

* During conductor connection, observe clearance and creepage distances. Insert partitions if necessary
 ** For Cat. No. **0180600000** and **0180700000**: length = 160 mm.

Feed-through terminals

SAKG 70 II G SAKG 70/35 II G



Ⓢ Ⓡ Ⓝ DNV

Width/length/height (mm)	with TS 32	32/84/54
Width/length/height (mm)	with TS 35 x 7.5	32/84/53
Insulation stripping length/clamping screw/screwdriver blade		-/M 8/-

Dimensions/approvals

Width/length/height (mm)	with TS 32	32/84/54
Width/length/height (mm)	with TS 35 x 7.5	32/84/53
Insulation stripping length/clamping screw/screwdriver blade		-/M 8/-

Rated data according to IEC 60 947-7-1

Rated voltage/current/cross-section	1000 V*/192 A/70 mm ²
Rated impulse voltage/pollution severity	8 kV/3

Further technical data

Tightening torque range	Nm	6...12
Torque setting with electric screwdriver type DMS 2		

Clampable conductor

Solid H07V-U	mm ²	
Stranded H07V-R	mm ²	10...95
Flexible H07V-K	mm ²	10...95
Flexible H07V-K and ferrule according to DIN 46 228/1	mm ²	10...35
Plug gauge according to 60 947-7-1	Size	B 12
Continuous current of terminal for conductor size		192 A/90 mm ²
Continuous current rating of cross-connection 2...5-pole	A	(QL 2) 192
Continuous current rating of cross-connection 6...10-pole	A	

Rated data according to UL/CSA

Voltage/current/conductor size	UL	600 V/200 A/2/0...4/0 AWG
Voltage/current/conductor size	CSA	600 V/250 A/2/0...4/0AWG

Ordering data

Version	KrG	
Qty.		0150420000 10 0636620000 10

SAKG 40 I SAKG 40/35 I

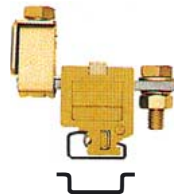

Ⓢ Ⓡ Ⓝ Ⓡ

Width/length/height (mm)	40/95/84
Width/length/height (mm)	46/95/85.5
Insulation stripping length/clamping screw/screwdriver blade	27 mm/M 10/-

SAKG 40 II SAKG 40/35 II



Ⓢ Ⓡ Ⓝ Ⓡ DNV

Width/length/height (mm)	40/90/53
Width/length/height (mm)	46/90/53
Insulation stripping length/clamping screw/screwdriver blade	-/M 10/-

SAKG 40 II G SAKG 40/35 II G



Ⓢ Ⓡ Ⓝ Ⓡ

Width/length/height (mm)	40/90/55
Width/length/height (mm)	46/90/55
Insulation stripping length/clamping screw/screwdriver blade	-/M 10/-

Rated voltage/current/cross-section	1000 V*/232 A/95 mm ²
Rated impulse voltage/pollution severity	8 kV/3

Tightening torque range	Nm	10...20
Torque setting with electric screwdriver type DMS 2		

Solid H07V-U	mm ²	
Stranded H07V-R	mm ²	10...95
Flexible H07V-K	mm ²	10...95
Flexible H07V-K and ferrule according to DIN 46 228/1	mm ²	10...35
Plug gauge according to 60 947-7-1	Size	B 12
Continuous current of terminal for conductor size		232 A/95 mm ²
Continuous current rating of cross-connection 2...5-pole	A	(QL 2) 232
Continuous current rating of cross-connection 6...10-pole	A	

Voltage/current/conductor size	UL	600 V/230 A/4/0 AWG
Voltage/current/conductor size	CSA	600 V/250 A/2/0...4/0 AWG

Version		
Qty.		0170520000 10 0637720000 5 0185220000 10 0637820000 5

End plate, hard paper (thickness mm)

0205100000, 0180500000		
0205200000, 0180600000	tropic-proof	

EP 1 (2)	0205100000	10
EP 1 (2)	0205200000	10

0180700000, 0205300000		
0180800000, 0205400000	tropic-proof	

EP 1/35 (2)	0180500000	10
EP 1/35 (2)	0180600000	10

Partition, hard paper (thickness mm)

0151400000		
0164600000	tropic-proof	

TW 1 (2)	0151400000	10
TW 1 (2)	0164600000	10

0177100000	B/L/H (incl. TS 32) mm	2/120/75.5
0179900000	B/L/H (incl. TS 35) mm	2/120/75.5

Cross-connection

2-pole, QL 2		
3-pole, QL 3		
4-pole, QL 4		

Qty.		
Qty.		
Qty.		

Cover

AH 32	0326760000	5
-------	------------	---



Marking tags

1 2 3 4 5 6	DEK	Standard
-------------	-----	----------

DEK 5	see "Accessories"	
-------	-------------------	--

Mounting rails, end brackets, further marking material see "Accessories"

*During conductor connection, observe clearance and creepage distances. Insert partitions if necessary.

Feed-through terminals

SAKG 40 III SAKG 40/35 III



UL @ CE E
40/100/84
46/100/85.5
27 mm/M 10/-
1000 V*/232 A/95 mm ²
8 kV/3
10...20
10...95
10...95
10...95
10...35
B 12
232 A/95 mm ²

600 V/195 A/4/0 AWG
600 V/230 A/2/0...4/0 AWG
Qty. Qty.
0286920000 10 0637620000 5

EP 2 (2)	Cat. No.	Qty.
EP 2 (2)	0205300000	10
EP 2 (2)	0205400000	10

EP 2/35 (2)	Cat. No.	Qty.
EP 2/35 (2)	0180700000	10
EP 2/35 (2)	0180800000	10

TW 2 (2)	Cat. No.	Qty.
TW 2 (2)	0177100000	10
TW 2 (2)	0179900000	10

2/160/90.5
2/160/90.5

QL 2	0247000000	5
QL 3	0444400000	5
QL 4	0444500000	5

AH 40	0326860000	5
-------	------------	---

DEK 5	see "Accessories"
-------	-------------------

SAKG 46 II SAKG 46/35 II



UL @ CE E
46/106/55
46/106/54.5
-/M 12/-
1000 V*/309 A/150 mm ²
8 kV/3
14...31
309 A/150 mm ²

600 V/285 A/4/0 AWG
600 V/365 A/300 MCM
Qty. Qty.
0170620000 10 0637920000 5

EP 2 (2)	Cat. No.	Qty.
EP 2 (2)	0205300000	10
EP 2 (2)	0205400000	10

EP 2/35 (2)	Cat. No.	Qty.
EP 2/35 (2)	0180700000	10
EP 2/35 (2)	0180800000	10

TW 2 (2)	Cat. No.	Qty.
TW 2 (2)	0177100000	10
TW 2 (2)	0179900000	10

2/160/90.5
2/160/90.5

QL 2	0247000000	5
QL 3	0444400000	5
QL 4	0444500000	5

AH 46	0326960000	5
-------	------------	---

DEK 5	see "Accessories"
-------	-------------------

SAKG 46 II G SAKG 46/35 II G



CE @ CE DNV
46/106/57.5
46/106/57
-/M 12/-
1000 V*/309 A/150 mm ²
8 kV/3
14...31
309 A/150 mm ² (QL 2) 309

600 V/285 A/4/0 AWG
600 V/365 A/300 MCM
Qty. Qty.
0185320000 10 0638020000 5

EP 2 (2)	Cat. No.	Qty.
EP 2 (2)	0205300000	10
EP 2 (2)	0205400000	10

EP 2/35 (2)	Cat. No.	Qty.
EP 2/35 (2)	0180700000	10
EP 2/35 (2)	0180800000	10

TW 2 (2)	Cat. No.	Qty.
TW 2 (2)	0177100000	10
TW 2 (2)	0179900000	10

2/160/90.5
2/160/90.5

QL 2	0247000000	5
QL 3	0444400000	5
QL 4	0444500000	5

AH 46	0326960000	5
-------	------------	---

DEK 5	see "Accessories"
-------	-------------------

SAKG 54 II SAKG 54/35 II

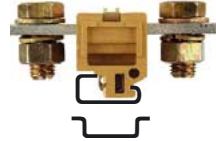

UL @ CE E
54/122/57
54/122/57
-/M 16/-
1000 V*/415 A/240 mm ²
8 kV/3
25...60
415 A/240 mm ² (QL 2) 415

600 V/380 A/500 MCM
600 V/600 A/300...500 MCM
Qty. Qty.
0170720000 10 0638120000 5

EP 2 (2)	Cat. No.	Qty.
EP 2 (2)	0205300000	10
EP 2 (2)	0205400000	10

EP 2/35 (2)	Cat. No.	Qty.
EP 2/35 (2)	0180700000	10
EP 2/35 (2)	0180800000	10

TW 2 (2)	Cat. No.	Qty.
TW 2 (2)	0177100000	10
TW 2 (2)	0179900000	10

2/160/90.5
2/160/90.5

QL 2	0264400000	5
QL 3	0408000000	5
QL 4	0247400000	5

DEK 5	see "Accessories"
-------	-------------------

SAKG 54 II G SAKG 54/35 II G

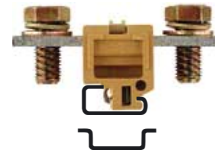

UL @ CE E DNV
54/122/60
54/122/60
-/M 16/-
1000 V*/415 A/240 mm ²
8 kV/3
25...60
415 A/240 mm ² (QL 2) 415

600 V/380 A/500 MCM
600 V/600 A/300...500 MCM
Qty. Qty.
0185420000 10 0638220000 5

EP 2 (2)	Cat. No.	Qty.
EP 2 (2)	0205300000	10
EP 2 (2)	0205400000	10

EP 2/35 (2)	Cat. No.	Qty.
EP 2/35 (2)	0180700000	10
EP 2/35 (2)	0180800000	10

TW 2 (2)	Cat. No.	Qty.
TW 2 (2)	0177100000	10
TW 2 (2)	0179900000	10

2/160/90.5
2/160/90.5

QL 2	0264400000	5
QL 3	0408000000	5
QL 4	0247400000	5

DEK 5	see "Accessories"
-------	-------------------

SAKG 46/I AL SAKG 46/II AL

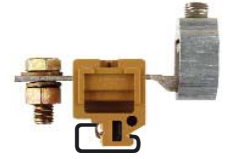

46/112/74
23 mm/M 12/M 14/-
1000 V*/309 A/150 mm ²
8 kV/3
14...31/25...40
50...240
35...185

Qty. Qty.
1287920000** 5

EP 2 (2)	Cat. No.	Qty.
EP 2 (2)	0205300000	10
EP 2 (2)	0205400000	10

Qty. Qty.

TW 2 (2)	Cat. No.	Qty.
TW 2 (2)	0177100000	10
TW 2 (2)	0179900000	10

2/160/90.5
2/160/90.5

QL 2	0194000000	5
QL 3	0441500000	5
QL 4	0441600000	5

AH 46	0326960000	5
-------	------------	---

DEK 5	see "Accessories"
-------	-------------------

SAK-series

* During conductor connection, observe clearance and creepage distances. Insert partitions if necessary.
** Suitable for connection of 1 aluminium conductor of max 185 mm²

*** Suitable for connection of 2 aluminium conductors of max. 185 mm²

Stud terminals

SS 6 SS 6/35



KST 5 KST 5/35



KST 6 KST 6/35

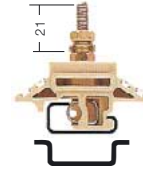

KST 8 KST 8/35

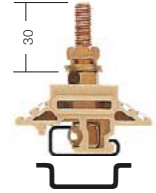

Dimensions/approvals

Width/length/height (mm)	with TS 32	
Width/length/height (mm)	with TS 35 x 7.5	
Insulation stripping length/clamping screw/screwdriver blade		

Rated data

Rated voltage/current/cross-section		
Rated impulse voltage/pollution severity		

Further technical data

Tightening torque range	Nm	
Torque setting with electric screwdriver type DMS 2		

Clampable conductor

Solid H07V-U	mm ²	
Stranded H07V-R	mm ²	
Flexible H07V-K	mm ²	
Flexible H07V-K and ferrule according to DIN 46 228/1	mm ²	
Plug gauge according to 60 947-7-1	Size	
Continuous current of terminal for conductor size		
Continuous current rating of cross-connection 2...5-pole	A	
Continuous current rating of cross-connection 6...10-pole	A	

Rated data according to UL/CSA

Voltage/current/conductor size	UL	
Voltage/current/conductor size	CSA	

Ordering data

Version		Qty.	
KrG			
PA			
PPO			
KrG			
for TS 35 x 7.5	PA		
for TS 35 x 15/2.3	PA		

18/40/62		
18/49.5/54.5		
-/M 6/-		

24/60/55		
24/62.5/49.5		
-/M 5/-		

24/60/62		
24/62.5/54.5		
-/M 6/-		

24/60/72		
24/62.5/64.5		
-/M 8/-		

1000 V ¹⁾ /76 A/16 mm ²		
6 kV/3		

1000 V ¹⁾ /57 A/10 mm ²		
8 kV/3		

1000 V ¹⁾ /76 A/16 mm ²		
8 kV/3		

1000 V ¹⁾ /125 A/35 mm ²		
8 kV/3		

3...6		

2...4		

3...6		

6...12		

82 A/16 mm ²		

65 A/10 mm ²		

82 A/16 mm ²		
200		

135 A/35 mm ²		
200		

Partition, (thickness mm)

PA			
Hard paper			
HM			
HM			



Width/length/height (incl. TS 32) mm		
Width/length/height (incl. TS 35) mm		

Cross-connection

2-pole	QL 2		
3-pole	QL 3		



Marking tags

1	2	3	4	5	6	DEK	Standard
---	---	---	---	---	---	-----	----------

Mounting rails, end brackets, further marking material see "Accessories"

Cat. No.	Qty.
----------	------

TW SS6 (TS32)	0455860000	10
TW GW2 (TS35)	0607100000	20

--	--	--

TW right	1718530000	10
TW left 2)	1752800000	10

--	--	--

TW right	1718530000	10
TW left	1752800000	10

--	--	--

TW right	1718530000	10
TW left	1752800000	10

2/129/93		
2/70/62.5		

2/160/83.5		
2/160/78.5		

2/160/83.5		
2/160/78.5		

2/160/83.5		
2/160/78.5		

QL 2	0284300000	20
QL 3	0279000000	20

QL 2	9503390000	1
------	------------	---

QL 2	9501350000	5
------	------------	---

QL 2	9501360000	1
------	------------	---

DEK 5	see "Accessories"
-------	-------------------

DEK 5	see "Accessories"
-------	-------------------

DEK 5	see "Accessories"
-------	-------------------

DEK 5	see "Accessories"
-------	-------------------

* Depends on cable lug

1) with partition

2) Left AP is required only once at beginning of terminal strip

Stud terminals

KST 10
KST 10/35

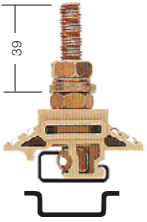

34/60/82			34/60/82		
34/62.5/74.5			34/62.5/74.5		
-/M 10/-			-/M 12/-		
1000 V ¹⁾ /192 A/70 mm ²			1000 V ¹⁾ /232 A/95 mm ²		
8 kV/3			8 kV/3		
10...20			14...31		
207 A/70 mm ²			250 A/95 mm ²		
200			200		
600 V/175 A/12...2/0			600 V/200 A/12...3/0		
	Qty.		Qty.		Qty.
9501330000	20				
9506960000	20		9506970000	20	
9528330000	20		9528340000	20	
	+				
TW right	1718530000	10	TW right	1718530000	10
TW left	1752800000	10	TW left	1752800000	10
2/160/83.5			2/160/83.5		
2/160/78.5			2/160/78.5		
QL 2	9501370000	1	QL 2	9501380000	1
DEK 5	see "Accessories"		DEK 5	see "Accessories"	

PE terminals

EK 2.5 N EK 2.5/35



EK 4 EK 4/35



EK 6/35



EK 10 EK 10/35



Dimensions/approvals

Width/length/height (mm)	with TS 32	6/36.5/49.5	8/40/51.5	8/56/44	10/40/51.5
Width/length/height (mm)	with TS 35 x 7.5	6/56/40	6.5/56/44	12 mm/M 3.5/4.0/0.8	10/56/44
Insulation stripping length/clamping screw/screwdriver blade		10 mm/M 2.5/3.5 x 0.6	12 mm/M 3/3.5 x 0.6		12 mm/M 4/5.5 x 1.0

Rated data according to IEC 60 947-7-2

Rated voltage/current with PEN/cross-section		-/-/2.5 mm ²	-/-/4 mm ²	-/-/6 mm ²	-/-/10 mm ²
Rated voltage/rated impulse voltage acc. to VDE 0110/1.89/ pollution severity					

Further technical data

Tightening torque range	Nm	0.4...0.8/0.5...1.0*	0.5...1.0/0.5...1.0*	1.2...1.6/0.5...1.0*	1.2...2.4/0.5...1.0*
-------------------------	----	----------------------	----------------------	----------------------	----------------------

Clampable conductor

Solid H07V-U	mm ²	0.5...4	0.5...6	0.5...10	0.5...10
Stranded H07V-R	mm ²	0.5...2.5	0.5...4	1.5...6	1.5...6
Flexible H07V-K	mm ²	0.5...4	0.5...4	0.5...10	0.5...10
Flexible H07V-K and ferrule DIN 46 228/1	mm ²	0.5...2.5	0.5...4	0.5...6	0.5...10
Cable AWG	Nr.	22...14	22...10	20...8	20...8
Plug gauge according to 60 947-7-1	Size	A 3	A 4	A 5	B 6

Ordering data

Version	Qty.	Qty.	Qty.	Qty.					
Green/yellow PA		0474360000 100	0661060000 100	0354560000 100	0661160000 100		0661260000 100	0354660000 80	0661360000 100
Blank									
Two clamping yokes blank									
Hexagon socket blank									

Support block



For insulation of mounting rails
in insulated-earth installations

Type	Cat. No.	Qty.	Type	Cat. No.	Qty.	Type	Cat. No.	Qty.	Type	Cat. No.	Qty.
SH 2	0494920000	10	SH 2	0494920000	10	SH 2	0494920000	10	SH 2	0494920000	10

SK - key, 8mm

Marking tags

Print	DEK	Standard	DEK 6	see "Accessories"	DEK 6.5	see "Accessories"	DEK 8	see "Accessories"	DEK 5	see "Accessories"
	1	2	3	4	5	6				

Mounting rails, end brackets, further marking material see "Accessories"

* For centre screw

PE terminals

EK 16
EK 16/35



12/50/57.5	16 mm/M 4/5.5 x 1.0
12/56/50	-/-/16 mm ²
1.2...2.4/0.8...1.0*	2.5...16
2.5...16	2.5...16
2.5...16	2.5...16
4...16	4...16
12...6	12...6
B 6	B 6
Qty. Qty.	Qty. Qty.
0374660000 50	0190160000 50

Type	Cat. No.	Qty.
SH 2	0494920000	10

DEK 5 see "Accessories"

EK 35**
EK 35/35



18/58/67.5	20 mm/M 6/6.5 x 1.2
16/58/60	-/-/35 mm ²
2.5...5.0/ **	6...16
16...50	16...50
10...35	10...35
10...35	10...35
10...2	10...2
B 9	B 9
Qty. Qty.	Qty. Qty.
0354760000 20	0661460000 20

Type	Cat. No.	Qty.
SH 2	0494920000	10

DEK 5 see "Accessories"

EK 2



10/52/38	14 mm/M 4/-
-/-/10	
1.2...2.4/2.0...4.0*	1.5...10
1.5...10	1.5...10
1.5...10	1.5...10
1.5...10	1.5...10
16...8	16...8
B 6	B 6
Qty.	Qty.
0323100000	20

Type	Cat. No.	Qty.
------	----------	------

SAKE 35



14/46/39	16 mm/M 6/-
-/-/35 mm ²	
2.5...5.0/2.0...4.0*	6...35
6...35	6...35
6...16	6...16
10...35	10...35
8...2	8...2
B 8	B 8
Qty. Qty.	Qty. Qty.
0144400000	20

Type	Cat. No.	Qty.
SH 2	0494920000	10

SAKE 70

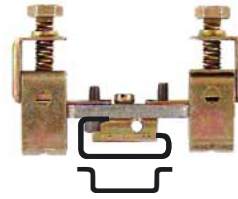

18/94/59.5	25 mm/M 8/-
-/-/70 mm ²	
6.0...12/2.0...4.0*	10...70
10...70	10...70
10...70	10...70
6...0	6...0
B 10	B 10
Qty. Qty.	Qty. Qty.
0213200000	20
1338300000	10

Type	Cat. No.	Qty.
SH 2	0494920000	10

EK 95/35



25/76/100/92	27 mm/M 10/-
-/-/95 mm ²	
10.0...20.0/1.2...2.4*	10...120
10...95	10...95
10...95	10...95
10...95	10...95
6...4/0	6...4/0
B 12	B 12
Qty.	Qty.
0535300000	10
0535400000	10

Type	Cat. No.	Qty.
------	----------	------

0235000000

SAK-series

** ADm f. EK 35/35 = 1.2 - 2.4 Nm
ADm f. EK 35 = 0.8 - 1.6 Nm

Fuse terminals

KSKM 1 KSKM 1/35

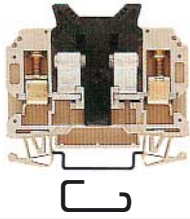

13/69/62
13/69/63
12 mm/-/-

250 V/6.3 A¹⁾/10 mm²

0.5...16

0.5...10

B 6

600 V/10 A/22...8 AWG

Qty. Qty.

9509570000 20 9509600000 20

Type	Cat. No.	Qty.
AP (3)	9509630000	20

5 x 20 mm

0.10 (f)	0430300000	10
0.20 (f)	0430400000	10
0.25 (f)	0430500000	10
0.50 (f)	0430600000	10
1.00 (f)	0430700000	10
1.60 (f)	0430800000	10
2.00 (f)	0430900000	10
2.50 (f)	0431000000	10
3.15 fast	0431100000	10
4.0 fast	0431200000	10
5.0 fast	0431300000	10
6.3 fast	0431400000	10

5 x 20 SBL 0446100000 40

DEK 5 see "Accessories"

KSKM 2 KSKM 2/35

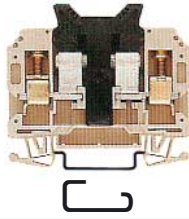

13/69/62
13/69/63
12 mm/-/-

250 V/13 A²⁾/10 mm²

0.5...16

0.5...10

B 6

600 V/15 A/22...8 AWG

Qty. Qty.

9509580000 20 9509610000 20

Type	Cat. No.	Qty.
AP (3)	9509630000	20

1 x 1/4"

1 x 1/4" SBL 0446200000 40

DEK 5 see "Accessories"

KSKM 3 KSKM 3/35

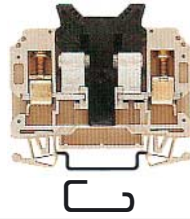

13/69/62
13/69/63
12 mm/-/-

440 V/10 A/10 mm²

0.5...16

0.5...10

B 6

600 V/15 A/22...8 AWG

Qty. Qty.

9509620000 20

Type	Cat. No.	Qty.
AP (3)	9509630000	20

1 1/4 x 1/4"

E 2 A	0294500000	10
E 3 A	0295700000	10
E 5 A	0294600000	10
E 7 A	0295800000	10
E 10 A	0293900000	10

1 1/4 x 1/4" SBL 0446300000 40

DEK 5 see "Accessories"

¹⁾ Max. fuse rating according to DIN 41 660, IEC 127 CEE4 Type 1
²⁾ Fuse according to BS 1362

Fuse terminals

SAKS 4 USA



UL		
24/75/73		
24/75/66		
14 mm/M 4/5.5 x 1		
400 V/30 A/10 mm ²		
6 kV/3		
1.2...2.4		
4		
0.5...16		
1.5...10		
0.5...10		
0.5...10		
B 6		
(QL 2...5) 47		
(QL 6...10) 36		
600 V/30 A/20...8 AWG		
600 V/30 A/22...8 AWG		
	Qty.	Qty.
0162220000	20	0178220000
10.3 x 38,1		
Type	Cat. No.	Qty.
TW HP (2.0)	0607000000	20
QL 2	0328000000	20
QL 3	0328100000	20
QL 4	0328200000	20
QL 10	0339000000	20
SS M 4	0136400000	100
BS M 4 x 9	0103300000	100
SK (w. spring)	0161730000	20
DEK 5	see "Accessories"	

Fuse terminals with fault indicator



Dimensions/approvals	
Terminal width (+ 0.2 assembly tolerance)	mm 8
Insulation stripping length	mm 9
Connection data	
Screw connection, solid	
Screw connection, flexible/ferrule with/without plastic collar	
Conductor cross-section	
VDE rated data	
Current	
Voltage	
LED-current (24...60 V)	
LED-current (115...230 V)	
LED-current (24...230 V)	
Incandescent lamp-current	
Neon lamp-current	
Cross-section	
Ordering data	
↔ 24 V~	ASK 1 LD 8050810000 25
↔ 24 V~	ASK 1 LD 0222760000 25
↔ 48 V~	ASK 1 LD 0225260000 25
↔ 60 V~	ASK 1 LD 0226460000 25
↔ 115 V~	ASK 1 LD 0225460000 25
↔ 230 V~	ASK 1 LD 0225660000 25
24 V~	ASK 1 LD 0222860000 25
48 V~	ASK 1 LD 0225360000 25
60 V~	ASK 1 LD 0226360000 25
115 V~	ASK 1 LD 0225560000 25
230 V~	ASK 1 LD 0225760000 25
Mountable on	
TS 32 and TS 35	
Accessories	
Mounting rail	
End brackets (thickness mm)	
for TS 32	
for TS 35	
End plate/End plate (thickness mm)	
Cross-connections	
Type 'QL'	
Cross-connection	
Type 'QB'	
Fixing screw (fits QL)	
Disconnect lever (spare)	
TH (spare)	0377060000 100
Mounting rails, end brackets, further marking material see "Accessories"	

ASK 1 LD

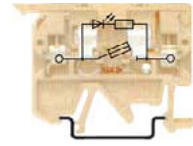

Warning:
In the event of a faulty fuse, the connection system is live!

UL		
0.5...4 mm ²		
0.5...4 mm ²		
AWG 22...12		
6.3 A		
24...230 V (depending on terminal)		
≤ 2 mA		
≤ 2 mA		
4 mm ²		
Type	Cat. No.	Qty.
ASK 1 LD	8050810000	25
ASK 1 LD	0222760000	25
ASK 1 LD	0225260000	25
ASK 1 LD	0226460000	25
ASK 1 LD	0225460000	25
ASK 1 LD	0225660000	25
ASK 1 LD	0222860000	25
ASK 1 LD	0225360000	25
ASK 1 LD	0226360000	25
ASK 1 LD	0225560000	25
ASK 1 LD	0225760000	25
Mountable on		
TS 32 and TS 35		
Accessories		
Mounting rail		
End brackets (thickness mm)		
End plate/End plate (thickness mm)		
Cross-connections		
Type 'QL'		
Cross-connection		
Type 'QB'		
Fixing screw (fits QL)		
Disconnect lever (spare)		
TH (spare)	0377060000	100

KDKS 1

Fuse insert 5x20

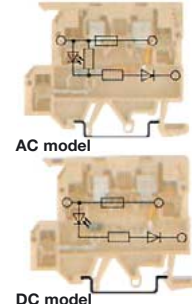

Warning:
In the event of a faulty fuse, the connection system is live!

UL		
0.5...4 mm ²		
0.5...4 mm ²		
AWG 22...12		
6.3 A		
24...230 V (depending on terminal)		
≤ 2 mA		
≤ 2 mA		
4 mm ²		
Type	Cat. No.	Qty.
KDKS 1	8146450000	25
KDKS 1	8148930000	25
KDKS 1	8148920000	25
KDKS 1	8142840000	25
KDKS 1	8148910000	25
Mountable on		
TS 32 and TS 35		
Accessories		
Mounting rail		
End brackets (thickness mm)		
End plate/End plate (thickness mm)		
Cross-connections		
Type 'QL'		
Cross-connection		
Type 'QB'		
Fixing screw (fits QL)		
Disconnect lever (spare)		
TH (spare)	0377060000	100

SAK-series

¹⁾When using QB, the rated cross-current reduces to max. 2.5 mm²

Fuse terminals

with fault indicator



Dimensions/approvals	
Width/length/height (mm)	with TS 32
Width/length/height (mm)	with TS 35 x 7.5
Terminal width (+ 0.2 assembly tolerance)	mm
Insulation stripping length/clamping screw/screwdriver blade	

Connection data	
Screw connection, solid	
Screw connection, flexible	
Conductor cross-section	

Further technical data	
Tightening torque range	Nm
Torque setting with electric screwdriver type DMS 2	

VDE rated data	
Voltage/current	
LED-current (24...60 V)	
LED-current (115...230 V)	
Incandescent lamp-current	
Neon lamp-current	
Cross-section	

Ordering data	Voltage	Qty.
Fuse insert		
5 x 20	LED	24 V~
Acc. to IEC 60127-2 (VDE 0820 T.2 BI 1)		24 V~
without indicator		48 V~
		48 V~
	Incandescent lamp	24 V=
		48 V=
	Neon lamp	115 V=
		230 V=
Fuse insert		
5 x 25	LED	24 V~
Acc. to DIN 41576		
without indicator	Incandescent lamp	48 V=
	Neon lamp	115 V=
		230 V=

Accessories	
Mounting rail	
End brackets (thickness mm)	for TS 32 for TS 35
End plate (thickness mm)	
Cross-connection	
Type 'QL'	
Cross-connection	
Type 'QB'	
Fixing screw (fits QL)	
Screw cap (spare)	
Neon lamp	

SAKS 1

Fuse insert 5x20/5x25

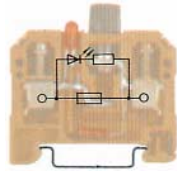

Warning:
In the event of a faulty fuse, the connection system is live!

Dimensions/approvals	
Width/length/height (mm)	
Terminal width (+ 0.2 assembly tolerance)	mm
Insulation stripping length/clamping screw/screwdriver blade	

Further technical data	
Tightening torque range	Nm
Torque setting with electric screwdriver type DMS 2	

VDE rated data	
Voltage/current	
LED-current (24...60 V)	
LED-current (115...230 V)	
Incandescent lamp-current	
Neon lamp-current	
Cross-section	

Ordering data	Voltage	Qty.
Fuse insert		
5 x 20	LED	24 V~
Acc. to IEC 60127-2 (VDE 0820 T.2 BI 1)		24 V~
without indicator		48 V~
		48 V~
	Incandescent lamp	24 V=
		48 V=
	Neon lamp	115 V=
		230 V=
Fuse insert		
5 x 25	LED	24 V~
Acc. to DIN 41576		
without indicator	Incandescent lamp	48 V=
	Neon lamp	115 V=
		230 V=

Type	Cat. No.	Qty.
TS 32	0122800000	
TS 35x7.5	0383400000	
TS 35x15	0498000000	
EWK 1 (8.5)	0206160000	50
EW 35 (8.5)	0383560000	50
AP KrG (3)	0191320000	20
SK (5 x 20)	0282100000	20
SK (5 x 25)	0282000000	100

SAKS 4

Fuse insert E14/D 01
(e.g. Neozed D 01)

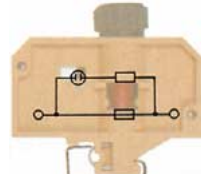

Warning:
In the event of a faulty fuse, the connection system is live!

Dimensions/approvals	
Width/length/height (mm)	
Terminal width (+ 0.2 assembly tolerance)	mm
Insulation stripping length/clamping screw/screwdriver blade	

Further technical data	
Tightening torque range	Nm
Torque setting with electric screwdriver type DMS 2	

VDE rated data	
Voltage/current	
LED-current (24...60 V)	
LED-current (115...230 V)	
Incandescent lamp-current	
Neon lamp-current	
Cross-section	

Type	Cat. No.	Qty.
SAKS 4		
TS 32 Neon lamp		
Voltage		
115 V=	0101820000	10
480 V=	0102120000	10

Type	Cat. No.	Qty.
TS 32	0122800000	
EWK 1 (8.5)	0206160000	50

SAKS 6

Fuse insert 11/4" x 1/4"
acc. to DEF 63

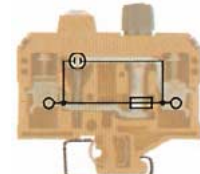

Warning:
In the event of a faulty fuse, the connection system is live!

Dimensions/approvals	
Width/length/height (mm)	
Terminal width (+ 0.2 assembly tolerance)	mm
Insulation stripping length/clamping screw/screwdriver blade	

Further technical data	
Tightening torque range	Nm
Torque setting with electric screwdriver type DMS 2	

VDE rated data	
Voltage/current	
LED-current (24...60 V)	
LED-current (115...230 V)	
Incandescent lamp-current	
Neon lamp-current	
Cross-section	

Type	Cat. No.	Qty.
SAKS 6 KrG	0531820000	40
for 1 1/4" x 1/4" acc. to DEF 63		
Voltage		
115 V=	0101820000	10
480 V=	0102120000	10
exchangable neon lamps (please order separately)		

Type	Cat. No.	Qty.
TS 32	0122800000	
EWK 1 (8.5)	0206160000	50
AP KrG	0146720000	20
QL 2	0191400000	50
QL 3	0191500000	50
QL 4	0191600000	20
QL 10	0338800000	20
BSM 3x6 m.SS	0346200000	100
Neon lamp 230 V~	0550300000	
Neon lamp 115 V~	0550200000	

SAKS 7

Fuse insert 5x20/5x25

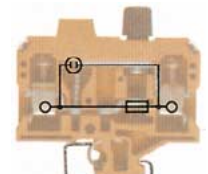

Warning:
In the event of a faulty fuse, the connection system is live!

Dimensions/approvals	
Width/length/height (mm)	
Terminal width (+ 0.2 assembly tolerance)	mm
Insulation stripping length/clamping screw/screwdriver blade	

Further technical data	
Tightening torque range	Nm
Torque setting with electric screwdriver type DMS 2	

VDE rated data	
Voltage/current	
LED-current (24...60 V)	
LED-current (115...230 V)	
Incandescent lamp-current	
Neon lamp-current	
Cross-section	

Type	Cat. No.	Qty.
SAKS 7 KrG		
for 5 x 25	0576120000	40
SAKS 7 KrG		
for 5 x 20	0573120000	40
exchangable neon lamps (please order separately)		

Type	Cat. No.	Qty.
TS 32	0122800000	
EWK 1 (8.5)	0206160000	50
AP KrG (3)	0146720000	20
QL 2	0207800000	20
QL 3	0207900000	20
QL 4	0208000000	20
QL 10	0338900000	20
BSM 4x9 m.SS	0133300000	100
Neon lamp 230 V~	0550300000	
Neon lamp 115 V~	0550200000	

Fuse inserts and gauge rings for Weidmüller fuse terminals



Fuse inserts

for terminal type	Size (mm)	Rated voltage (V)	Rated current (A)	Type	Cat. No.	Qty.
G fuse inserts 5 x 20 without indicator acc. to IEC 60127-2 (VDE 0820 T.2 Bl 1)						
SAKS 1	5 x 20 Breaking capacity 1500 A (at 250 V, 50 Hz, cos φ = 0.7)	250	0.1 (F)	G 20/0.10A/F	0430300000	10
SAKS 7			0.2 (F)	G 20/0.20A/F	0430400000	10
ASK 1			0.25 (F)	G 20/0.25A/F	0430500000	10
WSI 6 			0.5 (F)	G 20/0.50A/F	0430600000	10
			0.63 (F)	G 20/0.63A/F	0430900000	10
			1.0 (F)	G 20/1.00A/F	0430700000	10
			1.6 (F)	G 20/1.60A/F	0430800000	10
			2.0 (F)	G 20/2.00A/F	0430900000	10
			2.5 (F)	G 20/2.50A/F	0431000000	10
			3.15 (F)	G 20/3.15A/F	0431100000	10
			4.0 (F)	G 20/4.00A/F	0431200000	10
			5.0 (F)	G 20/5.00A/F	0431300000	10
			6.3 (F)	G 20/6.30A/F	0431400000	10
G fuse inserts 5 x 25 with indicator acc. to DIN 41576¹⁾						
SAKS 1	5 x 25 m. K.1) Breaking capacity 80 A (at 250 V, 50 Hz, cos φ = 1)	250	0.25 (M)	G 25/0.25A/M	0546900000	10
SAKS 7			0.5 (M)	G 25/0.50A/M	0510300000	10
WSI 6 			0.8 (M)	G 25/0.80A/M	0646400000	10
			1 (M)	G 25/1.00A/M	0265800000	10
			10 (M) ⁵⁾	G 25/10.0A/M	0193100000	10
			2 (F)	G 25/2.00A/F	0192700000	10
			4 (F)	G 25/4.00A/F	0192800000	10
			6.3 (F)	G 25/6.30A/F	0192900000	10
			Fuse inserts 1 1/4" x 1/4" without indicator acc. to BS 88			
SAKS 3 ²⁾	33 kA Breaking capacity 33 kA fast	440	E 0.5 A	GZ 0.5A/F	0533800000	10
SAKS 6 			E 1 A	GZ 1.0A/F	0525500000	10
			E 2 A	GZ 2.0A	0294500000	10
			E 3 A	GZ 3.0A	0295700000	10
			E 5 A	GZ 5.0A	0294600000	10
			E 7 A	GZ 7.0A	0295800000	10
			E 10 A	GZ 10.0A	0293900000	10
D fuse inserts E 16 with indicator acc. to DIN 49360 (diazed)						
SAKS 2 	E 10 A E 16 A E 20 A E 25 A	500	10	E 16/10A RT	0208500000	25
			16	E 16/16A GR	0208600000	25
			20	E 16/20A BL	0208700000	25
			25	E 16/25A GE	0208800000	25
D fuse inserts E 14 Size D 01 and E 18 size D 02 with indicator acc. to DIN 49522 (neozed)³⁾						
SAKS 4 ⁴⁾ 	E 14/2 E 14/4 E 14/6 E 14/10 E 14/16 E 18/20	400	2	E 14/2A RS	0137400000	10
			4	E 14/4A BR	0137500000	10
			6	E 14/6A GN	0328300000	10
			10	E 14/10A RT	0328400000	10
			16	E 14/16A GR	0328500000	10
			20	E 18/20A BL	0361300000	10
SAKS 5 	E 18/25 E 18/35 E 18/50 E 18/63	400	25	E 18/25A GE	0361400000	10
			35	E 18/35A SW	0361500000	10
			50	E 18/50A WS	0361600000	10
			63	E 18/63A KU	0361700000	10

(F) = fast
(M) = medium-delayed action

- Note:**
- 1) The SIBA company also supplies 5 x 25 G fuse inserts with indicators in a shipbuilding model for 450 V AC.
 - 2) 5 x 30 (500 V AC) fuse inserts for SAKS 3 are available from the WICKMANN company
 - 3) The LINDNER company also supplies neozed fuse cartridges in an additional shipbuilding mode for 440 V AC.
 - 4) Fuse cartridges with the dimensions 1"x1/4" ≅ 25.4x6.35 mm and 13/32"x1 1/8" ≅ 10.3x38.1 mm are not included in product line.
 - 5) Only for SAKS 1 and SAKS 7.

Gauge rings

For terminal type	Gauge ring type	Amp.	Colour	Type	Cat. No.	Qty.
SAKS 4 and 4/35 	P 14/2	2	Pink	P 14/2D01 RS	0138000000	50
	P 14/4	4	Brown	P 14/4D01 BR	0138100000	50
	P 14/6	6	Green	P 14/6D01 GN	0328600000	50
	P 14/1	10	Red	P 14/10D01 RT	0328700000	50
SAKS 5 and 5/35 	P 18/20	20	Blue	P 18/20D02 BL	0361800000	50
	P 18/25	25	Yellow	P 18/25D02 GE	0361900000	50
	P 18/35	35	Black	P 18/35D02 SW	0362000000	50
	P 18/50	50	White	P 18/50D02 WS	0362100000	50
SAKS 2 and 2/35 	P 16/10	10	Red	P 16/10 RT	0208900000	100
	P 16/16	16	Grey	P 16/16 GR	0209000000	100
	P 16/20	20	Blue	P 16/20 BL	0209100000	100

Disconnect test terminals

SAKR SAKR/35



SAKR-D SAKR-D/35

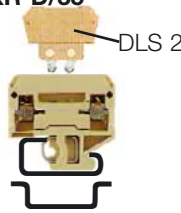

DKT 4 DKT 4/35

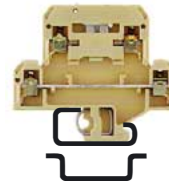

DKT 4 V DKT 4 V/35

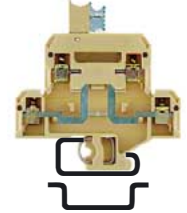

Dimensions/approvals		SAKR SAKR/35	SAKR-D SAKR-D/35	DKT 4 DKT 4/35	DKT 4 V DKT 4 V/35
Width/length/height (mm)	with TS 32	6.5/42/40.5/54.5 (opened)	6.5/42/40.5/57 (with DLS 2)	6/65/56.5/70 (opened)	6/65/56.5/70 (opened)
Width/length/height (mm)	with TS 35 x 7.5	6.5/46/38/52	6.5/46/38/54.5	6/65/56.5/70	6/65/56.5/70
Insulation stripping length/clamping screw/screwdriver blade		8 mm/M 3/3.5 x 0.6	8 mm/M 3/3.5 x 0.6	9 mm/M 3/3.5 x 0.6	9 mm/M 3/3.5 x 0.6
Rated data					
Rated voltage/current/cross-section		400 V ⁶⁾ /10 A/4 mm ²	400 V/10 A/4 mm ²	400V/10 A/4 mm ²	400 V/10 A/4 mm ²
Rated impulse voltage/pollution severity		6 kV/3	6 kV/3	6 kV/3	6 kV/3
Further technical data					
Tightening torque range	Nm	0.5...1.0/0.5 StB	0.5...1.0/0.5 StB	0.5...1.0/0.5 StB	0.5...1.0/0.5 StB
Torque setting with electric screwdriver type DMS 2		2/1	2/1	2/1	2/1
Clampable conductor					
Solid H07V-U	mm ²	0.5...4	0.5...4	0.5...4	0.5...4
Stranded H07V-R	mm ²	1.5...4	1.5...4	1.5...4	1.5...4
Flexible H07V-K	mm ²	0.5...4	0.5...4	0.5...4	0.5...4
Flexible H07V-K and ferrule according to DIN 46 228/1	mm ²				
With/without plastic insulating collar	mm ²	0.5...4	0.5...4	0.5...4	0.5...4
Plug gauge according to 60 947-7-1	Size	A 3	A 3	A 3	A 3
Continuous current rating of cross-connection 2...5-pole	A	(QB 2...25) 10	(QB 2...25) 10	(QB 2...4) 10	(QB 2...4) 10
Continuous current rating of cross-connection 6...10-pole	A				
Rated data according to UL/CSA					
Voltage/current/conductor size	UL	300 V/10 A/26...12 AWG	300 V/10 A/26...12 AWG	300 V/10 A/22...12 AWG	300 V/10 A/22...12 AWG
Voltage/current/conductor size	CSA	300 V/10 A/26...12 AWG	300 V/10 A/22...12 AWG	300 V/10 A/26...12 AWG	300 V/10 A/26...12 AWG
Ordering data		Type Qty. Qty.	Type Qty. Qty.	Type Qty. Qty.	Type Qty. Qty.
	KrG	0412120000 100			
	PA	0412160000 100 0172160000 100	0412960000 ¹⁾ 100 0299960000 ²⁾ 50	0687360000 50 0687460000 50	
	Without diode PA		0413060000 ³⁾ 50 0185760000 ³⁾ 50		
	With diode PA		0263660000 ³⁾ 50 0299560000 ³⁾ 50		
	Blue PA	0412180000 100 0172180000 100			
	Orange PA	1461960000 100			
	KrG	0412220000 100			
With 2 StB ⁵⁾	PA	0412260000 100 0183360000 100	0546460000 ¹⁾ 100	0327860000 50 0327960000 50	1304860000 50 1304960000 50
With 2 StB ⁵⁾	without diode PA		0413160000 ²⁾ 50		
With 2 StB ⁵⁾	Blue	0412280000 100 0183380000 100			
End plate (thickness mm)		Type Cat. No. Qty.	Type Cat. No. Qty.	Type Cat. No. Qty.	Type Cat. No. Qty.
	KrG	AP (1.5) 0211320000 20	AP (1.5) 0211360000 20	AP (1.5) 0687560000 20	AP (1.5) 0687560000 20
	PA	AP (1.5) 0211360000 20			
	Blue PA	AP (1.5) 0211380000 20			
Partition (thickness mm)					
		TW HP (1.0) 0297100000 20	TW HP (1.0) 0297100000 20	TW HP (2.0) 0607000000 20	TW HP (2.0) 0607000000 20
Cross-connection					
QB 4	2-pole	QB 2 ⁴⁾ 0482700000 100	QB 2 ⁴⁾ 0482700000 100	QB 2 ⁴⁾ 0482700000 100	QB 2 ⁴⁾ 0482700000 100
	3-pole	QB 3 ⁴⁾ 0482800000 50	QB 3 ⁴⁾ 0482800000 50	QB 3 ⁴⁾ 0482800000 50	QB 3 ⁴⁾ 0482800000 50
	4-pole	QB 4 ⁴⁾ 0482900000 50	QB 4 ⁴⁾ 0482900000 50	QB 4 ⁴⁾ 0482900000 50	QB 4 ⁴⁾ 0482900000 50
	25-pole	QB 25 blank ⁴⁾ 0134000000 20	QB 25 blank ⁴⁾ 0134000000 20		
Contact sleeve (spare)					
Test plug		PS 2.3 0180400000 20	PS 2.3 0180400000 20	PS 2.3 0180400000 20	PS 2.3 0180400000 20
Diode plug (spare)					
	without diode		DLS 2 0321060000 50		
	with diode 1N4007		DLS 2 + 0630160000 50		
	with diode 1N4007		DLS 2 - 0547760000 50		
	with jumper		DLS 2 0547660000 25		
Marking tags		Print			
	DEK Standard	DEK 6.5 see "Accessories"	DEK 6.5 see "Accessories"	DEK 6 see "Accessories"	DEK 6 see "Accessories"
Mounting rails, end brackets, further marking material see "Accessories"					

¹⁾ without DLS
²⁾ with DLS empty

³⁾ with DLS 1N4007
⁴⁾ When using QB the rated cross-current reduces to max. 2.5 mm²

⁵⁾ With DKT 4 only on upper terminal level
⁶⁾ As disconnect test terminal rated voltage 250 V

Disconnect test terminals

ASK 1 ASK 1/35

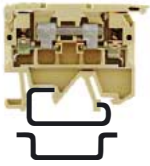

RU @

8/58/49

8/58/44

9 mm/M 3/3.5 x 0.6

500 V/19 A/4 mm²

6 kV/3

0.5...1.0

2

0.5...4

1.5...4

0.5...4

0.5...4

A 3

(QB 2...4) 10

300 V/15 A/12 max. AWG

300 V/6.3 A/26...12 AWG

Qty.

0456360000 100

0105260000 100

Type	Cat. No.	Qty.
AP (1.5)	0380360000	20
TW HP (2.0)	0607000000	20
QB 2 ⁴⁾	0461100000	100
QB 3 ⁴⁾	0461200000	50
QB 4 ⁴⁾	0461300000	50
multipole interruptable with group marking carrier SchS 2; 2-pole (Cat. No. 1359500000) 1000 mm (Cat. No. 0337400000)		
K sleeve	0553300000	100
DEK 5 FW	see "Accessories"	

Feed-through terminals with tab connection

AST 1 AST1/35

6.3
2.8

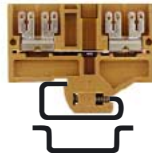

UL @ DNV

Dimensions/approvals	
Width/length/height (mm)	with TS 32
Width/length/height (mm)	with TS 35 x 7.5
Insulation stripping length/clamping screw/screwdriver blade	

6.5/58/53.5
6.5/58/46

AST 3 AST 3/35

6.3
2.8



UL @ DNV

6.5/40/47.5
6.5/44/40

AST 4 AST 4/35

6.3
2.8



UL @

6.5/40/47.5
6.5/44/40
9 mm/M 2.5/3.5 x 0.6

AST 5 AST 5/35

6.3
2.8

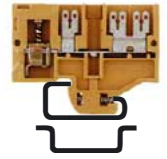

UL @ DNV

6.5/58/53.5
6.5/58/46
12 mm/M 3/3.5 x 0.6

Rated data	
Rated voltage/-current	500 V ¹⁾ /-
Rated cross-section for clamping yokes	-
Rated cross-section tab	6.3/2.8 mm
Rated Voltage VDE 0110/1.89/pollution severity	6 kV/3
Further technical data	
Tightening torque range	Nm
Torque setting with electric screwdriver type DMS 2	
Clampable conductor	
Solid H07V-U	mm ²
Stranded H07V-R	mm ²
Flexible H07V-K	mm ²
Flexible H07V-K and ferrule according to DIN 46 228/1	mm ²
Plug gauge according to 60 947-7-1	Size
Continuous current of terminal for conductor size	
Continuous current rating of cross-connection 2...5-pole	A
Continuous current rating of cross-connection 6...10-pole	A

Rated data according to UL/CSA	
Voltage/current/conductor size	UL
Voltage/current/conductor size	CSA
Ordering data	
	Version
	Slotted KrG
	Slotted blue KrG
	Slotted PA
	Unslotted KrG
	Unslotted blue KrG
	Unslotted PA

Type	Cat. No.	Qty.
AP (3.0)	0266420000	20
AP (1.5)	0266460000	20
PA	0474700000	20
HP	0607000000	20
HP	0319160000	100

Type	Cat. No.	Qty.
AP (3.0)	0298120000	20
AP (1.5)	0460560000	20
TW (1.5)	0130160000	20
TW (1.0)	0297100000	20
TSch 1	0319160000	100

Type	Cat. No.	Qty.
AP (3.0)	0298120000	20
AP (1.5)	0460560000	20
TW (1.5)	0130160000	20
TW (1.0)	0297100000	20
TSch 1	0319160000	100

Type	Cat. No.	Qty.
AP (3.0)	0266420000	20
AP (1.5)	0266460000	20
TW (1.0)	0474700000	20
TW (2.0)	0607000000	20
TSch 1	0319160000	100

End plate/partition/small partition (thickness mm)		
AP	TW	TSCH 1
		KrG
		Blue KrG
		PA
		HP
		HP
		Only for PA
		TSch 1

Cross-connection	
Q4	2-pole
	3-pole
	4-pole
	10-pole
	25-pole

Plug adapter	
	2-pole
	3-pole
	4-pole
	5-pole
	8-pole

Test plug/socket	
	Plug-test socket without using QL for TS 32
	PS
	StB

Insulation sleeve	
	IH 2.8
	IH 6.3

Marking tags	
	Print
	DEK
	Standard

Mounting rails, end brackets, further marking material see "Accessories"

¹⁾ with insulation sleeve
²⁾ shock proof with ADP 4 cover profiles ADP4 (see section "Accessories")

Feed-through terminals with tab connection

SAK 4 S SAK 4 S/35

6.3
2.8



Width/length/height (mm)	6.5/40/51.5
Width/length/height (mm)	6.5/40/49.5
Insulation stripping length/clamping screw/screwdriver blade	12 mm/M 3/3.5 x 0.6

Dimensions/approvals

Width/length/height (mm)	with TS 32	
Width/length/height (mm)	with TS 35 x 7.5	
Insulation stripping length/clamping screw/screwdriver blade		

Rated data

Rated voltage/-current	500 V ¹⁾ /16 A
Rated cross-section for clamping yokes	4 mm ²
Rated cross-section tab	6.3/2.8 mm
Rated Voltage VDE 0110/1.89/pollution severity	6 kV/3

Further technical data

Tightening torque range	Nm	0.5...1.0
Torque setting with electric screwdriver type DMS 2		2

Clampable conductor

Solid H07V-U	mm ²	0.33...6
Stranded H07V-R	mm ²	1.5...4
Flexible H07V-K	mm ²	0.5...4
Flexible H07V-K and ferrule according to DIN 46 228/1	mm ²	0.5...4
Plug gauge according to 60 947-7-1	Size	A 4
Continuous current of terminal for conductor size		
Continuous current rating of cross-connection 2 pole	A	(QL 2...10) 36 A at 6 mm ²
Continuous current rating of cross-connection multipole	A	

Rated data according to UL/CSA

Voltage/current/conductor size	UL	300 V/13 A/26...12 AWG
Voltage/current/conductor size	CSA	300 V/13 A/26...12 AWG

Ordering data

Version

Slotted KrG		Qty.		Qty.
Slotted blue KrG				
Slotted PA				
Unslotted KrG				

0401220000	100
0401260000	100
0630360000	100

SAK 4 SS SAK 4 SS/35

6.3
2.8



Width/length/height (mm)	6.5/40/51.5
Width/length/height (mm)	6.5/40/49.5

Rated voltage/-current	500 V ¹⁾ /16 A
Rated cross-section for clamping yokes	-
Rated cross-section tab	2.5/1.0 mm ²
Rated Voltage VDE 0110/1.89/pollution severity	6 kV/3

Tightening torque range		
Torque setting with electric screwdriver type DMS 2		

Solid H07V-U	mm ²	0.33...6
Stranded H07V-R	mm ²	1.5...4
Flexible H07V-K	mm ²	0.5...4
Flexible H07V-K and ferrule according to DIN 46 228/1	mm ²	0.5...4
Plug gauge according to 60 947-7-1	Size	A 4
Continuous current of terminal for conductor size		
Continuous current rating of cross-connection 2 pole	A	(QL 2...10) 36 A at 6 mm ²
Continuous current rating of cross-connection multipole	A	

Voltage/current/conductor size	UL	300 V/13 A/18...14 AWG
Voltage/current/conductor size	CSA	300 V/13 A/18...14 AWG

0479620000	10
0479660000	100
0630460000	100
0352920000	10

SAKR F SAKR F/35

2.8



Width/length/height (mm)	6.5/42/40.5/54.5 (opened)
Width/length/height (mm)	6.5/42/40.5/32.5
Insulation stripping length/clamping screw/screwdriver blade	8 mm/M 3/3.5 x 0.6

Rated voltage/-current	250 V ¹⁾ /10 A
Rated cross-section for clamping yokes	4 mm ²
Rated cross-section tab	-/1.0 mm ²
Rated Voltage VDE 0110/1.89/pollution severity	6 kV/3

Tightening torque range	Nm	0.5...1.0
Torque setting with electric screwdriver type DMS 2		1

Solid H07V-U	mm ²	0.5...4
Stranded H07V-R	mm ²	1.5...4
Flexible H07V-K	mm ²	0.5...4
Flexible H07V-K and ferrule according to DIN 46 228/1	mm ²	0.5...2.5
Plug gauge according to 60 947-7-1	Size	A 3
Continuous current of terminal for conductor size		
Continuous current rating of cross-connection 2 pole	A	(QB 2...25) 10
Continuous current rating of cross-connection multipole	A	

Voltage/current/conductor size	UL	300 V/10 A/22...12 AWG
Voltage/current/conductor size	CSA	300 V/10 A/26...12 AWG

0663660000	100
6382870000	100
with 1 StB 6	

End plate/partition/small partition (thickness mm)

Type	Cat. No.	Qty.
AP (1.5)	0117920000	20
AP (1.5)	0117960000	20
AP (1.5)	0130160000	20
TW (1.0)	0297100000	20



Type	Cat. No.	Qty.
AP (1.5)	0117920000	20
AP (1.5)	0117970000	20
AP (1.5)	0117960000	20
TW (1.5)	0130160000	20
TW (1.0)	0297100000	20

Type	Cat. No.	Qty.
AP (1.5)	0117920000	20
AP (1.5)	0117970000	20
AP (1.5)	0117960000	20
TW (1.5)	0130160000	20
TW (1.0)	0297100000	20

Type	Cat. No.	Qty.
AP (1.5)	0211360000	20
TW (1.0)	0297100000	20

Cross-connection

QL 2	2-pole	QL 2	0130600000	100
QL 3	3-pole	QL 3	0130700000	100
QL 4	4-pole	QL 4	0130800000	50
QL 10	10-pole	QL 10	0338200000	20
QL 25	25-pole	QL 25	0338200000	20

BS M 3 x 4.5



BS M 3 x 24



BS M 3x4.5 1593210000 100

BS M 3x4.5 1593210000 100

QB 2*	0482700000	100
QB 3*	0482800000	50
QB 4*	0482900000	50
QB 25 blank*	0134000000	20

Test plug/socket



PS 2.3 0180400000 20

Insulation sleeve



IH 2.8	0386060000	100
IH 6.3	0386260000	100

IH 2.8	0386060000	100
IH 6.3	0386260000	100

IH 2.8 0386060000 200

Marking tags

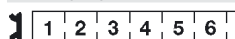

DEK Standard

DEK 6.5	see "Accessories"
---------	-------------------

DEK 6.5	see "Accessories"
---------	-------------------

DEK 6.5	see "Accessories"
---------	-------------------

Mounting rails, end brackets, further marking material see "Accessories"

¹⁾ With insulation sleeve

¹⁾ The conductor cross-section for the screw connection is reduced to 2.5 mm² when QB is used

Feed-through terminals with tab connection

DK 4 SS/35



DK 4 SS/35 only 2.8



DK 4 S DK 4 S/35

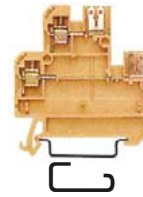

DK 4 S only 2.8 DK 4 S/35 only 2.8

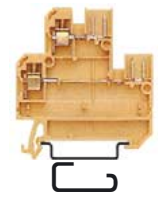

Dimensions/approvals

Width/length/height (mm)	with TS 32	
Width/length/height (mm)	with TS 35 x 7.5	
Insulation stripping length/clamping screw/screwdriver blade		

Rated data

Rated voltage/-current	400 V ¹ /2 x 16 A
Rated cross-section for clamping yokes	-
Rated cross-section tab	6.3/2.8 mm
Rated Voltage VDE 0110/1.89/pollution severity	8 kV/3

Further technical data

Tightening torque range	Nm
Torque setting with electric screwdriver type DMS 2	

Clampable conductor

Solid H07V-U	mm ²
Stranded H07V-R	mm ²
Flexible H07V-K	mm ²
Flexible H07V-K and ferrule according to DIN 46 228/1	mm ²
With/without plastic insulation collar	
Plug gauge according to 60 947-7-1	Size
Continuous current of terminal for conductor size	
Continuous current rating of cross-connection 2 pole	A
Continuous current rating of cross-connection multipole	A

Rated data according to UL/CSA

Voltage/current/conductor size	UL	300 V/10 A/22...12 AWG
Voltage/current/conductor size	CSA	300 V/10 A/22...12 AWG

Ordering data

Version	PA
---------	----

UL

UL	LR
6/54/60.5	

UL

UL	LR
6/54/60.5	

UL

UL	LR
6/54/59.5	
6/54/60.5	
9 mm/M 3/3.5 x 0.6	

UL

UL	LR
6/54/59.5	
6/54/60.5	
9 mm/M 3/3.5 x 0.6	

End plate (thickness mm)



PA

Type	Cat. No.	Qty.
AP (1.5)	0631360000	20

Type	Cat. No.	Qty.
AP (1.5)	0631360000	20

Type	Cat. No.	Qty.
AP (1.5)	0631360000	20

Type	Cat. No.	Qty.
AP (1.5)	0631360000	20

Partition



for TS 32 HP

Type	Cat. No.	Qty.
TW HP (2.0)	0607000000	20

Type	Cat. No.	Qty.
TW HP (2.0)	0607000000	20

Type	Cat. No.	Qty.
TW HP (2.0)	0607000000	20

Type	Cat. No.	Qty.
TW HP (2.0)	0607000000	20

Small partition



TSch 6

Type	Cat. No.	Qty.
TSch 6	0190260000	100

Type	Cat. No.	Qty.
TSch 6	0190260000	100

Type	Cat. No.	Qty.
TSch 6	0190260000	100

Type	Cat. No.	Qty.
TSch 6	0190260000	100

Cross-connection



Q 3

2-pole	Q 2	0336400000	50
3-pole	Q 3	0336500000	50
4-pole	Q 4	0336600000	50
10-pole	Q 10	0368600000	20

2-pole	Q 2	0336400000	50
3-pole	Q 3	0336500000	50
4-pole	Q 4	0336600000	50
10-pole	Q 10	0368600000	20

2-pole	Q 2	0336400000	50
3-pole	Q 3	0336500000	50
4-pole	Q 4	0336600000	50
10-pole	Q 10	0368600000	20

2-pole	Q 2	0336400000	50
3-pole	Q 3	0336500000	50
4-pole	Q 4	0336600000	50
10-pole	Q 10	0368600000	20

Test plug/socket



StB

Plug test socket without using QL
Plug test socket for use with QL

StB 8.5	0215700000	50
---------	-------------------	----

StB 8.5	0215700000	50
---------	-------------------	----

StB 8.5	0215700000	50
---------	-------------------	----

StB 8.5	0215700000	50
---------	-------------------	----

Insulation sleeve



PS

PS 2.3	0180400000	20
--------	-------------------	----

PS 2.3	0180400000	20
--------	-------------------	----

PS 2.3	0180400000	20
--------	-------------------	----

PS 2.3	0180400000	20
--------	-------------------	----

Marking tags

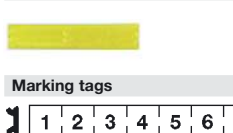

DEK

Print

Standard

DEK 6	see "Accessories"
-------	-------------------

DEK 6	see "Accessories"
-------	-------------------

DEK 6	see "Accessories"
-------	-------------------

DEK 6	see "Accessories"
-------	-------------------

Mounting rails, end brackets, further marking material see "Accessories"

¹) With insulation sleeve

Feed-through terminals for wrap termination

DIN 41 611, Part 2 and
for spring-clip termination
DIN 41 611, Part 4

SAK 2.5 T

Pin 1 x 1



SAK 2.5 T

Pin 0.8 x 1.6



SAK 2.5 T

Pin 0.8 x 2.4



Dimensions/approvals		Ⓒ	Ⓒ	Ⓒ
Width/length/height (mm)	with TS 32	6/36.5/47.5/67	6/36.5/47.5/62	6/36.5/47.5/69
Insulation stripping length/clamping screw/screwdriver blade		12 mm/M 2.5/3.5 x 0.6	12 mm/M 2.5/3.5 x 0.6	12 mm/M 2.5/3.5 x 0.6
Rated data				
Rated voltage/current/cross-section		250 V/8 A/2.5 mm ²	250 V/10 A/2.5 mm ²	250 V/10 A/2.5 mm ²
Rated impulse voltage VDE 0110/1.89/pollution severity		4 kV/3	4 kV/3	4 kV/3
Further technical data				
Tightening torque range	Nm	0.4...0.7	0.4...0.7	0.4...0.7
Torque setting with electric screwdriver type DMS 2		1	1	1
Clampable conductor				
Solid H07V-U	mm ²	0.5...6	0.5...6	0.5...6
Stranded H07V-R	mm ²	0.5...2.5	0.5...2.5	0.5...2.5
Flexible H07V-K	mm ²	0.5...4	0.5...4	0.5...4
Flexible H07V-K and ferrule according to DIN 46 228/1	mm ²	0.5...2.5	0.5...2.5	0.5...2.5
Plug gauge according to IEC 60 947-1	Size	A 3	A 3	A 3
Continuous current of terminal for conductor size				
Continuous current rating of cross-connection 2-pole	A	(Q 2...10) 24	(Q 2...10) 24	(Q 2...10) 24
Continuous current rating of cross-connection multipole	A			
Rated data according to UL/CSA				
Voltage/current/conductor size	UL			
Voltage/current/conductor size	CSA	300 V/10 A/22...12 AWG	300 V/10 A/22...12 AWG	300 V/10 A/22...12 AWG
Ordering data		Pin	Version	
	Right		KrG	0108520000 100
	Horizontal right		KrG	0485920000 100
	Vertical left		KrG	0478820000 100
	Vertical right		KrG	0371020000 100
	2x vertical		KrG	0485020000 100
Right		PA	0108560000 ¹⁾ 100	
End plate (thickness mm)		Type	Cat. No.	Qty.
	KrG	AP (1.5)	0279520000	20
	PA	AP (1.5)	0279560000	20
AP (1.5)	KrG	AP (1.5)	0279520000	20
	PA	AP (1.5)	0279560000	20
Partition (thickness mm)		Type	Cat. No.	Qty.
	KrG	TW (2.5)	0302820000	20
	PA	TW (2.5)	0302820000	20
	PA	TW (1.5)	0302860000	20
	HP	TW (0.5)	0197100000	20
HP	TW (2.0)	0607000000	20	
TSch 1	KrG	TSch 1	0319160000	100
	PA	TSch 1	0319160000	100
	2-pole	Q 2	0337000000	50
	3-pole	Q 3	0337100000	50
	4-pole	Q 4	0337200000	50
	10-pole	Q 10	0368700000	20
	Q 2**	0337000000	50	
Q 3**	0337100000	50		
Q 4**	0337200000	50		
Q 10**	0368700000	20		
Test plug/socket		Pin	Version	
	Plug-test socket without using QL	StB 8.5 (ø 2.3)	0280600000	50
	PS	PS 2.3	0180400000	20
	Print	DEK 6	see "Accessories"	
	Standard	DEK 6	see "Accessories"	

** Not for Type 2 x vertical"

¹⁾ Shock-proof with ADP4 cover profile (see section "Accessories")

Feed-through terminals

Disconnect terminals for wrap connection acc. to DIN 41 611, Part 2 and for spring-clip connection acc. to DIN 41 611, Part 4

DK 4 T

Pin 1 x 1



DK 4 T

Pin 0.8 x 1.6



DK 4 T

Pin 0.8 x 2.4



SAKRT

Pin 1 x 1/0.8 x 2.4 and 0.8 x 1.6



Dimensions

Width/length/height (mm) with TS 32  Insulation stripping length/clamping screw/screwdriver blade

Rated data

Rated voltage/current/cross-section
Rated impulse voltage VDE 0110/1.89/pollution severity

Further technical data

Tightening torque range Nm
Torque setting with electric screwdriver type DMS 2

Clampable conductor



Solid H07V-U mm²
Stranded H07V-R mm²
Flexible H07V-K mm²
Flexible H07V-K and ferrule according to DIN 46 228/1
With/without plastic insulating collar mm²
Plug gauge according to IEC 60 947-1 Size

Continuous current of terminal block for conductor size
Continuous current rating of cross-connection 2-pole A
Continuous current rating of cross-connection multipole A

Rated data according to UL/CSA

Voltage/current/conductor size UL
Voltage/current/conductor size CSA

Ordering data

Pin	Type	Cat. No.	Qty.
 Horizontal assembly	Right	PA	
	Links	PA	
	Horizontal right	PA	
	Vertical right	PA	
 Vertical assembly	Vertical right	PA	
	Vertical right	Blue PA	
	Vertical	PA	
	Vertical left	PA	

DK 4 QT

bridgeable on both levels Right PA

End plate/partition (thickness mm)

Type	Cat. No.	Qty.	Type	Cat. No.	Qty.	Type	Cat. No.	Qty.	Type	Cat. No.	Qty.	
PA	AP (1.5)	0359260000	20	AP (1.5)	0359260000	20	AP (1.5)	0359260000	20	AP (1.5)	0211360000	20
	PA (DK4 QT)	1397160000	20									
Blue PA	AP (1.5)	0359280000	20	AP (1.5)	0359280000	20						
	TW (2.0)	0607000000	20	TW (2.0)	0607000000	20	TW (2.0)	0607000000	20	TW (2.0)	0607000000	20

Small partition

TSch 4	TSch 4	0363360000	100	TSch 4	0363360000	100	TSch 4	0363360000	100		
--------	--------	-------------------	-----	--------	-------------------	-----	--------	-------------------	-----	--	--

Cross-connection/covers

Q 3	Q 2	0336400000	50	Q 2	0336400000	50	Q 2	0336400000	50			
	Q 3	0336500000	50	Q 3	0336500000	50	Q 3	0336500000	50			
	Q 4	0336600000	50	Q 4	0336600000	50	Q 4	0336600000	50			
	Q 10	0368600000	20	Q 10	0368600000	20	Q 10	0368600000	20			
	QB 2*	0482700000	100	QB 2*	0482700000	100	QB 2*	0482700000	100	QB 2*	0482700000	100
	QB 3*	0482800000	50	QB 3*	0482800000	50	QB 3*	0482800000	50	QB 3*	0482800000	50
	QB 4*	0482900000	50	QB 4*	0482900000	50	QB 4*	0482900000	50	QB 4*	0482900000	50
	25-pole									QB 25 blank*	0134000000	20

Test plug/socket

StB	Plug-test socket without using QL	StB 8.5 (ø23)	0215700000	50	StB 8.5 (ø23)	0215700000	50	StB 8.5 (ø2.3)	0215700000	50	
PS		PS 2.3	0180400000	20	PS 2.3	0180400000	20	PS 2.3	0180400000	20	

FW/FS	dekafix 6	see "Accessories"	dekafix 6	see "Accessories"	dekafix 6	see "Accessories"		
-------	-----------	-------------------	-----------	-------------------	-----------	-------------------	--	--

Mounting rails, end brackets, further marking material see "Accessories"

* The conductor cross-section for the screw connection is reduced to 2.5 mm² when QB is used.
** Only to be used with PA-version

¹⁾ Shock-proof with ADP4 cover profile (see section "Accessories")

Feed-through terminals and disconnect test terminals

with solder connection

SAK 2.5/M.LS

With screen lug

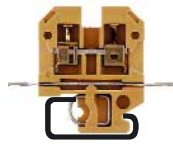

SAK 2.5 L SAK 2.5 L/35

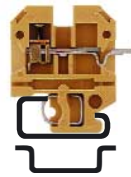

SAK 2.5 LL SAK 2.5 LL/35

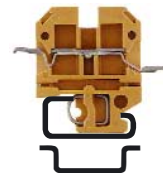

SAKR L SAKR L/35

Disconnect terminal



Dimensions/approvals		SAK 2.5/M.LS	SAK 2.5 L SAK 2.5 L/35	SAK 2.5 LL SAK 2.5 LL/35	SAKR L SAKR L/35
Width/length/height (mm)	with TS 32	6/60/46.5	6/44.5/46.5	6/55/46.5	6.5/50/40.5/54.5 (opened)
Width/length/height (mm)	with TS 35 x 7.5		6/44.5/40	6/55/40	6.5/50/38/52
Insulation stripping length/clamping screw/screwdriver blade		12 mm/M 2.5/3.5 x 0.6	12 mm/M 2.5/3.5 x 0.6		8 mm/M 3/3.5 x 0.6
Rated data					
Rated voltage/current/cross-section		250 V/20 A/2.5/1.5 mm ²	250 V/20 A/2.5/1.5 mm ²	250 V/20 A/1.5 mm ²	250 V/10 A/4/1.5 mm ²
Rated impulse voltage VDE 0110/1.89/pollution severity		4 kV/3	4 kV/3	4 kV/3	4 kV/3
Further technical data					
Tightening torque range	Nm	0.4...0.7	0.4...0.7		0.5...1.0
Torque setting with electric screwdriver type DMS 2		1	1		2/1
Clampable conductor					
Solid H07V-U	mm ²	0.5...6	0.5...6		0.5...4
Stranded H07V-R	mm ²	0.5...2.5	0.5...2.5		0.5...4
Flexible H07V-K	mm ²	0.5...4	0.5...4		0.5...4
Flexible H07V-K and ferrule according to DIN 46 228/1	mm ²	0.5...2.5	0.5...2.5		0.5...4
Plug gauge according to 60 947-7-1	Size	A 3	A 3		A 3
Continuous current of terminal block for conductor size					
Continuous current rating of cross-connection 2-pole	A	(Q 2...10) 24	(Q 2...10) 24	(Q 2...10) 24	(QB 2...25) 10
Continuous current rating of cross-connection multipole	A				
Rated data according to UL/CSA					
Voltage/current/conductor size	UL				300 V/10 A/22...12 AWG
Voltage/current/conductor size	CSA	300 V/10 A/22...12 AWG	300 V/10 A/22...12 AWG	300 V/10 A/26...12 AWG	300 V/10 A/22...12 AWG
Ordering data		Type Cat. No. Qty.	Qty. Qty.	Qty. Qty.	Qty.
	KrG	0309120000 100	0351420000 100	0323620000 100	
	Blue KrG		0351470000 100	0323670000 100	
	KrS				
	PA		0351460000 ²⁾ 0495060000 ²⁾ 100	0323660000 ²⁾ 0567260000 ²⁾ 100	0412360000 100
	Blue PA				0412380000 100
	KrG		0544120000 * 100		
	PA		0544160000 ²⁾ 100		0412460000 * 100
	Blue PA				0412480000 * 100
End plate/partition (thickness mm)		Type Cat. No. Qty.	Type Cat. No. Qty.	Type Cat. No. Qty.	Type Cat. No. Qty.
AP	TW	KrG AP (1.5) 0309220000 20	AP (1.5) 0309220000 20	AP (1.5) 0309220000 20	
		Blue KrG AP (1.5) 0309270000 20	AP (1.5) 0309270000 20	AP (1.5) 0309270000 20	
		PA AP (1.5) 0279560000 20	AP (1.5) 0279560000 20	AP (1.5) 0279560000 20	AP (1.5) 0211360000 ¹⁾ 20
		Blue PA AP (1.5) 0211380000 20			AP (1.5) 0211380000 20
		PA TW (1.5) 0302860000 20	TW (1.5) 0302860000 20	TW (1.5) 0302860000 20	
		HP TW (1.0) 0297100000 20	TW (1.0) 0297100000 20	TW (1.0) 0297100000 20	
		HP TW (2.0) 0607000000 20	TW (2.0) 0607000000 20	TW (2.0) 0607020000 20	TW (2.0) 0607000000 20
Small partition		TSch 1 0319160000 100	TSch 1 0319160000 100	TSch 1 0319160000 100	
Cross-connection					
Q 3	Q 4	2-pole Q 2 0337000000 50	Q 2 0337000000 50	Q 2 0337000000 50	QB 2** 0482700000 100
		3-pole Q 3 0337100000 50	Q 3 0337100000 50	Q 3 0337100000 50	QB 3** 0482800000 50
		4-pole Q 4 0337200000 50	Q 4 0337200000 50	Q 4 0337200000 50	QB 4** 0482900000 50
		10-pole Q 10 0368700000 20	Q 10 0368700000 20	Q 10 0368700000 20	
		25-pole			QB 25 blank** 0134000000 20
Test plug/socket					
	Plug-test socket without using QL		StB 8.5(ø23) 0280600000 50	StB 8.5(ø23) 0280600000 50	
	Plug-test-socket for use with QL		StB 29.5(ø4) 0133400000 50	StB 29.5(ø4) 0133400000 50	
			PS 2.3 0180400000 20	PS 2.3 0180400000 20	PS 2.3 0180400000 20
			PS 4 0299600000 20	PS 4 0299600000 20	
Cover		AD 4 0303400000 50	AD 4 0303400000 50	AD 4 0303400000 50	
		BSK M3x22 0128900000 100	BSK M3x22 0128900000 100	BSK M3x22 0128900000 100	
Marking tags		Print			
	DEK Standard	DEK 6 see "Accessories"	DEK 6 see "Accessories"	DEK 6 see "Accessories"	DEK 6.5 see "Accessories"
Mounting rails, end brackets, further marking material see "Accessories"					

SAK-series

* Soldering lug on left-hand side

** The conductor cross-section for the screw connection is reduced to 2.5 mm² when QB is used.

¹⁾ For TS 32 and TS 35

²⁾ Contact-proof cross-connection with ADP 4 cover profile (see "Accessories")

Disconnect test terminals with solder connections

SAKR L

With 2 StB 6



SAKR LL

With 2 StB 6

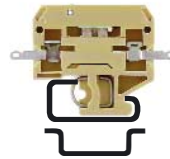

SAKR LL

With 2 StB 6



Dimensions/approvals

Width/length/height (mm)	with TS 32	
Width/length/height (mm)	with TS 35 x 7.5	
Insulation stripping length/clamping screw/screwdriver blade		

Rated data

Rated voltage/current/cross-section	250 V/10 A/4/1.5 mm ²
Rated impulse voltage VDE 0110/1.89/pollution severity	4 kV/3

Further technical data

Tightening torque range	Nm	0.5...1.0
Torque setting with electric screwdriver type DMS 2		1

Clampable conductor

Solid H07V-U	mm ²	0.5...4
Stranded H07V-R	mm ²	1.5...4
Flexible H07V-K	mm ²	0.5...4
Flexible H07V-K and ferrule according to DIN 46228/1		
With/without plastic insulating collar	mm ²	0.5...4
Plug gauge according to 60 947-7-1	Size	A 3

Continuous current of terminal block for conductor size		
Continuous current rating of cross-connection 2 pole	A	(QB 2...25) 10
Continuous current rating of cross-connection multipole	A	

Rated data according to UL/CSA

Voltage/current/conductor size	UL
Voltage/current/conductor size	CSA

Ordering data

Type	Qty.	Qty.
KrG		
Blue KrG		
KrS		
PA	0518160000	100
Blue PA		
KrG		
KrS		
PA	0572660000	100
Blue PA		

6.5/50/40.5/54.5 (opened)

8 mm/M 3/3.5 x 0.6

250 V/10 A/4/1.5 mm²

4 kV/3

0.5...1.0

1

0.5...4

1.5...4

0.5...4

0.5...4

A 3

(QB 2...25) 10

A



6.5/58/40.5/54.5 (opened)

250 V/10 A/1.5 mm²

4 kV/3

300 V/10 A/22...12 AWG

300 V/10 A/22...12 AWG

Qty.

Qty.

Qty.

Qty.

300 V/10 A/22...12 AWG

Qty.

Qty.

0464460000 100

Qty.

Qty.

6.5/58/40.5/54.5 (opened)

-/-/3.5 x 0.6

250 V/10 A/1.5 mm²

4 kV/3

Qty.

Qty.

Qty.

Qty.

Qty.

Qty.

Qty.

Qty.

Qty.

Qty.

0294260000 100

Qty.

Qty.

End plate/partition (thickness mm)

Type	Cat. No.	Qty.
AP		
TW		
KrG		
Blue KrG		
PA	AP (1.5) 0211360000	20
Blue PA	AP (1.5) 0211380000	20
PA		
HP	TW (0.5) 0474700000	20
HP	TW (2.0) 0607000000	20



Type Cat. No. Qty.

AP (1.5) 0211320000 20

AP (1.5) 0211360000 20

AP (1.5) 0211380000 20

TW (0.5) 0474700000 20

TW (2.0) 0607000000 20

Type Cat. No. Qty.

AP (1.5) 0211320000 20

AP (1.5) 0211360000 20

AP (1.5) 0211380000 20

TW (0.5) 0474700000 20

TW (2.0) 0607000000 20

Type Cat. No. Qty.

AP (1.5) 0211320000 20

AP (1.5) 0211360000 20

AP (1.5) 0211380000 20

TW (0.5) 0474700000 20

TW (2.0) 0607000000 20

Small partition



Cross-connection

Type	Cat. No.	Qty.
QB 3		
QB 4		
2-pole	QB 2** 0482700000	100
3-pole	QB 3** 0482800000	50
4-pole	QB 4** 0482900000	50
10-pole		
25-pole	QB 25 blank** 0134000000	20



Test plug/socket

Type	Cat. No.	Qty.
PS		
PS 2.3	0180400000	20



Marking tags

Type	Cat. No.	Print
DEK		Standard
DEK 6.5	see "Accessories"	

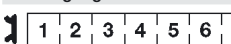

Mounting rails, end brackets, further marking material see "Accessories"

* Soldering lug on left-hand side

** The conductor cross-section for the screw connection is reduced to 2.5 mm² when QB is used.

Disconnect test terminals with solder connections

TAL
2 solder connections

TAL
4 solder connections

SAKK 4 **SAKK 10**
Ceramic feed-through terminals for use in high temperature ranges up to max. 210°C



Dimensions/approvals

Width/length/height (mm) with TS 32
 Width/length/height (mm) with TS 35 x 7.5
 Insulation stripping length/clamping screw/screwdriver blade

4/48/36/50 (opened)

4/54/36/50 (opened)

8/40/53

11.5/40/53

Rated data

Rated voltage/current/cross-section
 Rated impulse voltage VDE 0110/1.89/pollution severity

63 V/10 A/1.5 mm²
 1.5 kV/3

63 V/10 A/1.5 mm²
 1.5 kV/3

12 mm/M3/3.5 x 0.6
IEC 60 947-7-1
 800 V/32 A/4 mm²

12 mm/M 4/5.5 x 1.0
IEC 60 947-7-1
 800 V/57 A/10 mm²

Further technical data

Tightening torque range Nm
 Torque setting with electric screwdriver type DMS 2

0.5...1

1.2...2

Clampable conductor

Solid H07V-U mm²
 Stranded H07V-R mm²
 Flexible H07V-K mm²
 Flexible H07V-K and ferrule according to DIN 46 228/1 mm²
 Plug gauge according to 60 947-7-1 Size

0.5...6 mm²
 0.5...4 mm²

2.5...16 mm²
 2.5...10 mm²

Continuous current of terminal block for conductor size
 Continuous current rating of cross-connection 2 pole A
 Continuous current rating of cross-connection multipole A

A 4
 35 A/6 mm²
 36
 36

B 6
 63 A/16 mm²
 47
 36

Rated data according to UL/CSA

Voltage/current/conductor size UL
 Voltage/current/conductor size CSA

Ordering data

Type Cat. No. Qty.
 KrG
 Blue KrG
 KrS
 PA **0212060000** 100
 Blue PA
 KrG
 KrS
 PA
 Blue PA
 Ceramic

Cat. No. Qty.
0304960000 100

Cat. No. Qty.
 SAKK 4 **1598080000** 50
 AP/SAKK 4/10 **9502630000** 10

Cat. No. Qty.
 SAKK 10 **1598090000** 50
 AP/SAKK 4/10 **9502630000** 10

End plate/partition (thickness mm)

AP TW

 KrG
 Blue KrG
 PA **0212260000** 20
 Blue PA
 PA

Type Cat. No. Qty.
 AP (1.5) **0212260000** 20

Type Cat. No. Qty.
 AP (1.5) **0212260000** 20

Type Cat. No. Qty.
 SAKK 4 **1598080000** 50
 AP/SAKK 4/10 **9502630000** 10

Type Cat. No. Qty.
 SAKK 10 **1598090000** 50
 AP/SAKK 4/10 **9502630000** 10

Small partition

Cross-connection

Q 3 QB 4

 2-pole
 3-pole
 4-pole
 10-pole
 25-pole

Type Cat. No. Qty.
 QL 2 **9509420000** 100
 QL 3 **9509430000** 100
 QL 4 **9509440000** 50
 QL 10 **9509450000** 20
 VH 13.5 **0248500000** 100
 BS (M3 X 20) **0303000000** 100

Type Cat. No. Qty.
 QL 2 **9509470000** 100
 QL 3 **9509480000** 50
 QL 4 **9509490000** 50
 QL 10 **9509500000** 20
 VH 12.5 **9509510000** 50
 BS (M3 X 20) **0303000000** 100

Additional accessories

SST **0152700000**
 MEW 1/32 **0445600000**
 EK 2 **0323100000**

SST **0152700000**
 MEW 1/32 **0445600000**
 EK 2 **0323100000**

Marking tags

DEK Standard On demand

On demand

On demand

Mounting rails, end brackets, further marking material see "Accessories"

SAK-series

Feed-through terminals for initiators and actuators

DLI 2.5

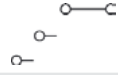

6/65/49	6/65/49
7 mm/M 2.5/3.5 x 0.6	7 mm/M 2.5/3.5 x 0.6

DLI 2.5 LD PNP

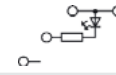

6/65/49	6/65/49
7 mm/M 2.5/3.5 x 0.6	7 mm/M 2.5/3.5 x 0.6

DLI 2.5 LD NPN

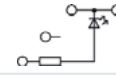

6/65/49	6/65/49
7 mm/M 2.5/3.5 x 0.6	7 mm/M 2.5/3.5 x 0.6

DLD 2.5



6/82/49	6/82/49
7 mm/M 2.5/3.5 x 0.6	7 mm/M 2.5/3.5 x 0.6

Dimensions/approvals

Width/length/height (mm)	with TS 35 x 7.5
Insulation stripping length/clamping screw/screwdriver blade	

Rated data according to IEC 60 947-7-1

Rated voltage/current/cross-section	250 V/20 A/2.5 mm ²
Rated impulse voltage/pollution severity	4 kV/3
Further technical data	
Tightening torque range	Nm 0.4...0.6
Torque setting with electric screwdriver type DMS 2	1
Clampable conductor	
Solid H07V-U	mm ² 0.5...4
Stranded H07V-R	mm ² 0.5...2.5
Flexible H07V-K	mm ² 0.5...4
Flexible H07V-K and ferrule according to DIN 46228/1	mm ² 0.5...2.5
Plug gauge according to 60 947-7-1	Size A 3
Continuous current of terminal for conductor size	20 A/2.5 mm ²
Continuous current rating of cross-connection 2...5-pole	A (Q 2...10) 20
Continuous current rating of cross-connection 6...10-pole	A

Rated data according to UL/CSA

Voltage/current/conductor size	UL 300 V/10 A/26...12 AWG
Voltage/current/conductor size	CSA 300 V/10 A/26...12 AWG

Ordering data

	Cat. No.	Qty.
Standard	1313360000	100
with diode 1N4007		
with LED red (5...30 V)	1578510000	100
with LED green (5...30 V)	1578520000	100
with LED and diode 1N4007		
with LED and diode 1N4007		
Block of 10 ¹⁾	(w/o) 1411360000	10
Block of 10 ¹⁾	(with dekafix) 1579070000	10
Fuse inserts		

End plate/Small partition

AP-DLI	AP-DLD	Part-AP	TSch 1	Type	Cat. No.	Qty.
				AP	1313260000	20
				TSch 1	0319160000	100

Test plug/plug socket

StB 8.5 (ø23)	0215700000	50
PS 2.3	0180400000	20

Cross-connection

Q 3	Q 2	Q 3	Q 4	Q 10	Q 20	QL 2	VH 4.2	VQB1.5/50BL	VQB1.5/50RT	VQB1.5/50SW
	1312500000	1312600000	1312700000	1313100000	1399800000	0297200000	1345800000	1633280000	1633290000	1635120000
	50	50	50	20	20	100	100	5	5	5

VQB

Snap fit, external cross-connection VQB 1.5.	For cross-connections for more than 20 terminals, replace VH with VH 4.2 (134580) without internal thread
--	---

Group marking

WT 4	1341060000	100
SF 10	0332400000	1000
SG 10	0332500000	1000

Cover

HP 4	0485400000	20
HP 4	0485860000	20

Marking tags

						DEK Standard	DEK 6 see "Accessories"
--	--	--	--	--	--	--------------	-------------------------

Mounting rails, end brackets, further marking material see "Accessories"

1) DLI 2.5/35/10 = Block of 10 with built-in cross-connections * only in upper busbar

Feed-through terminals for initiators and motors

VLI 1.5

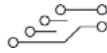

UL	6/79/64
Insulation stripping length/clamping screw/screwdriver blade	8 mm/M 2.5/3.5 x 0.6

VLI 1.5PE

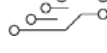

UL	6/69/63
Insulation stripping length/clamping screw/screwdriver blade	8 mm/M 2.5/3.5 x 0.6

MAK 2.5

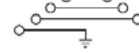

UL	6/88/64
Insulation stripping length/clamping screw/screwdriver blade	8 mm/M 2.5/3.5 x 0.6

Dimensions/approvals

Width/length/height (mm)	with TS 35 x 7.5
Insulation stripping length/clamping screw/screwdriver blade	8 mm/M 2.5/3.5 x 0.6

Rated data according to IEC 60 947-7-1

Rated voltage/current/cross-section	250 V/17.5 A/1.5 mm ²	250 V/17.5 A/1.5 mm ²	500 V (L-L)/250 V (L-PE) 24 A/2.5 mm ²
Rated impulse voltage/pollution severity	4 kV/3	4 kV/3	6 kV/3

Further technical data

Tightening torque range	Nm	0.4...0.6**	0.4...0.6	0.4...0.6
Torque setting with electric screwdriver type DMS 2		1	1	1

Clampable conductor

Solid H07V-U	mm ²	0.5...4.0	0.5...4.0	0.5...4.0
Stranded H07V-R	mm ²	0.5...2.5	0.5...2.5	0.5...2.5
Flexible H07V-K	mm ²	0.5...4	0.5...4	1.5...4
Flexible H07V-K and ferrule DIN 46 228/1	mm ²	0.5...2.5	0.5...2.5	0.5...2.5
Flexible H07V-K and ferrule with plastic insul. collar	mm ²	0.5...2.5	0.5...2.5	0.5...2.5
Plug gauge according to 60 947-7-1	Size	A3	A3	A3
Continuous current of terminal for conductor size		24 A/2.5 mm ²	24 A/2.5 mm ²	24 A/4 mm ²
Continuous current rating of cross-connection, multipole	A	24	24	24

Rated data according to UL/CSA

Voltage/current/conductor size	UL	300 V/10 A/26...12 AWG	300 V/10 A/26...12 AWG	300 V/10 A/26...12 AWG
Voltage/current/conductor size	CSA	300 V/10 A/26...12 AWG	300 V/10 A/26...12 AWG	300 V/10 A/26...12 AWG

Ordering data

Version	Cat. No.	Qty.	Version	Cat. No.	Qty.	Version	Cat. No.	Qty.
PA	1633250000	50	PA	1633310000	50	PA	1615270000	50
							1631650000	50

End plate/partition

Type	Cat. No.	Qty.	Type	Cat. No.	Qty.	Type	Cat. No.	Qty.
End plate	AP VLI1.5	1633260000	20	APVLI1.5/PE	1633320000	20	AP MAK2.5	1615280000
Partial end plate for VLI1.5 – MAK2.5 combination	TEAP2 MAK2.5	1633330000	20	TEAP VLI1.5	1633270000	20	TEAP2 MAK2.5	1633330000
Partial end plate for VLI1.5 – VLI1.5PE combination	TEAP VLI1.5	1633270000	20	TEAP1 MAK2.5	1633340000	20	TEAP1 MAK2.5	1633340000
Partial end plate for VLI1.5PE – MAK2.5 combination								

Cross-connection

VQB 50-pole, snap-fit, external cross-connection	VQB1.5/50BL* 1633280000	5	VQB1.5/50BL* 1633280000	5	VQB1.5/50BL* 1633280000	5
	VQB1.5/50RT* 1633290000	5	VQB1.5/50RT* 1633290000	5	VQB1.5/50RT* 1633290000	5
	VQB1.5/50SW* 1635120000	5	VQB1.5/50SW* 1635120000	5	VQB1.5/50SW* 1635120000	5
					QB 25 SW* 0520000000	20
					QB 25 RT* 0520060000	20
					QB 25 BL* 0520080000	20



QB 25-pole external cross-connection

Group marking

Tag carrier	T 5	0348500000	100	T 5	0348500000	100	T 5	0348500000	100
for S 10 tags	SF 10	0332400000	1000	SF 10	0332400000	1000	SF 10	0332400000	1000
	SG 10	0332500000	1000	SG 10	0332500000	1000	SG 10	0332500000	1000

Marking tags

Print	DEK	Standard	DEK 5	see "Accessories"	DEK 5	see "Accessories"	DEK 5	see "Accessories"
-------	-----	----------	-------	-------------------	-------	-------------------	-------	-------------------

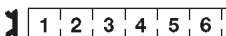

Mounting rails, end brackets, further marking material see "Accessories"

* When using cross-connection bridges, the connected cross-section is reduced by one level
 ** 0.4...0.45 for lower connection level

Disconnect test terminal against induced high voltage

PPT/35



SAKH 6



Measures to minimize risks of electric voltage peaks in control systems of power plants and transforming stations:

- Insulation between installation and control cable by pulling disconnect plugs.
- Grounding of control cable is possible on an appropriate location of the workplace.
- Easy connection of electric isolation of counting, control and communication circuits.

Electricity Supply Industry Standard ESI 12-4 1973

The Electricity Supply Industry Standard ESI 12-4 1973 defines a detailed specification of control and protection equipment. The main functions of these installations are as follows:

- Insulation of the control cables located in front of ground or installation lines with increased potential, which is required to prevent unintentional contact of service staff with live parts.
- Separation of control cables from local control circuits.
- Application also includes test connections for auxiliary control circuits and / or local control circuits.
- Grounding of control cables and / or auxiliary control circuits.
- Bundled disconnection of all auxiliary control circuits from potential earth.
- A test voltage can be applied using the screening connection of the control cable, which is normally routed on the enclosure, with the help of an appropriate separation. This permits to check whether the screening line is correctly functioning. For this test, an insulated feed-through plate is required.

ESI 12-4:

"Terminating Equipment for Pilot Cables subject to Induced Transient Voltages exceeding 650 V rms".

Dimensions/approvals						
Width/length/height (mm)	with TS 35 x 7.5		15/138/79			
Insulation stripping length/clamping screw/screwdriver blade			12 mm		12 mm	
Rated data according to IEC 60 947-7-1						
Rated voltage/current			15 kV ac (ESI 12-4)**/30 A		1 kV ac / 1.5 kV dc / 47 A	
Rated impulse voltage/pollution severity					>15 kV (from terminal to terminal)	
Clampable conductor						
Solid H07V-U	mm ²	0.5...10			0.5... 6	
Stranded H07V-R	mm ²	0.5...10*			0.5... 6	
Ordering data		Version	Cat. No.	Qty.	Cat. No.	Qty.
		EP	PPT/35 3835020000	10	SAKH 6 0126600000	50
			incl. disconnect plug and displacement tool (if min. 10 items are ordered)			
End plate						
		EP	AP/PPT (3) 3835120000	10	AP 0131700000	20
Disconnect plug						
			TST/PPT 3835360000	10		
Displacement tool						
		PA	PH/PPT 3835260000	10		
			The disconnect plug may only be removed with the displacement tool.			
Test plug/socket						
			PS (4) 0299600000	20		
			StB 17 0147100000	50		
Insulated mounting rail						
	PVC 35 x 1.5 mm		TSK 35 0514300000	1		
Marking tags		Print				
		DEK	Standard		DEK 5 see "Accessories"	DEK 5 see "Accessories"

DEK Standard

DEK 5 see "Accessories"

DEK 5 see "Accessories"

Mounting rails, end brackets, further marking material see "Accessories"

SAK-series

* Also two push-on tabs are possible
** mounted on an insulated mounting rail

Rail mounting TS 15

AK 4 AK 4/10



38.5 A / 6 mm²

60/32/34
9 mm/M 3/3.5 x 0.6
690 V/32 A/4 mm ²
8 kV/3
0.5...1.0
2
0.5...6
1.5...4
0.5...4
0.5...4
0.5...4
0.5...4
0.2...6.0 / A 3
20
20
TS 15 Cat. No. Qty.
0489560000 100
(10pol./no.mtk.) 0366560000 10
(10pol./w.mtk.) 0469560000 10
Type Cat. No. Qty.
BB 3 (8.0) 0366660000 50
combined AP + end brackets
TW/AP (1.5) 1331760000 20
TSch 4 0363360000 100
Q 2 0369000000 50
Q 3 0369100000 50
Q 4 0369200000 50
Q 10 0369300000 20
AD 4 0303400000 50
BSKM 25x18 0303300000 100
StB 8.5 0215700000 50
PS 2.3 0180400000 20
DEK 6 see "Accessories"

AKE 2.5



5/28/27
7 mm/M 2.5/3.0 x 0.5
IEC 60 947-7-2
-/-/2.5 mm ²
4 kV/3
0.4...0.6
1
0.5...4
1.5...2.5
0.5...4
0.5...2.5
0.5...2.5
0.13...4.0 / A 3
-/-/26...12 AWG
-/-/26...12 AWG
TS 15 Cat. No. Qty.
1303360000 100
(green/yellow)
Type Cat. No. Qty.
DEK 5 see "Accessories"

AKE 4



7/32/34
9 mm/M 3/3.5 x 0.6
IEC 60 947-7-2
-/-/4 mm ²
8 kV/3
0.5...1.0
2
0.5...6
1.5...4
0.5...4
0.5...2.5
0.5...2.5
0.13...4.0 / A 3
-/-/22...12 AWG
-/-/26...12 AWG
TS 15 Cat. No. Qty.
0380260000 100
(green/yellow)
Type Cat. No. Qty.
DEK 6.5 see "Accessories"

AKE 4 MS



7/27.5/30
9 mm/M 3/3.5 x 0.6
-/-/4 mm ²
0.8...1.6
3
0.5...4
1.5...4
0.5...4
0.5...4
0.5...4
0.5...4
0.5...4.0 / A 3
-/-/22...14 AWG
TS 15 Cat. No. Qty.
0211200000 50
Type Cat. No. Qty.

ASK 1

Fuse terminal



8/58/34
9 mm/M 3/3.5 x 0.6
500 V/6.3 A ¹ /4 mm ²
6 kV/3
0.5...1.0
2
0.5...4
1.5...4
0.5...4
0.5...2.5
0.5...2.5
0.13...4.0 / A 3
(QB 2...4) 10
300 V/10 A/22...12 AWG
300 V/6.3 A/26...12 AWG
TS 15 Cat. No. Qty.
0376860000 100
5 x 20 without indicator
AP (1.5) 0380360000 20
3-pole ganging with tag bar SchS 2, snapped onto three disconnect levers (Cat. No. 0337400000)
K sleeve 0553300000 100
DEK 6.5 see "Accessories"

SAKR

Isolating blade terminal with 2 sockets or with 2 clamping screws



6.5/42/45
8 mm/M 3/3.5 x 0.6
400 V ² /10 A/4 mm ²
6 kV/3
0.5...1.0
2
0.5...4
1.5...4
0.5...4
0.5...4
0.5...4
0.13...4.0 / A 3
(QB 2...4) 10
TS 15 Cat. No. Qty.
0412860000 100
with 2 StB
w. clamp.screw 0412760000 100
AP (1.5) 0211360000 20
QB 2 ¹) insul. 0482700000 50
QB 3 ¹) insul. 0482800000 50
QB 4 ¹) insul. 0482900000 50
QB 25 ¹) blank 0134000000 20
PS 2.3 0180400000 20
DEK 6.5 see "Accessories"

¹) The conductor cross-section is * With contact sleeve 19 A reduced to max. 2.5 mm² when QB is used.

²) As disconnect test terminal: rated voltage 250 V

Feed-through terminals for TS 15

Tab connection
Solder connection

AKZ 4 SS

AKZ 4 SS

AKZ 4 S

AKZ 4 SF



Dimensions/approvals	AKZ 4 SS	AKZ 4 SS	AKZ 4 S	AKZ 4 SF
Width/length/height (mm)	with TS 15 6/28.5/30.5	6/28.5/30.5	6/27/30	6/27/30
Insulation stripping length/clamping screw/screwdriver blade			9 mm/M 3/3.5 x 0.6	9 mm/M 3/3.5 x 0.6
Rated data				
Rated voltage*/current/cross-section	400 V/8 A/2.5/1 mm ²	400 V/8 A/1 mm ²	400 V/8 A/4/1 mm ²	400 V/8 A/4/1 mm ²
Rated impulse voltage VDE 0110/1.89/pollution severity	6 kV/3	6 kV/3	6 kV/3	6 kV/3
Further technical data				
Tightening torque range	Nm		0.5...1.0	0.5...1.0
Torque setting with electric screwdriver type DMS 2			2	2
Clampable conductor				
Solid H07V-U	mm ²		0.5...4	0.5...4
Stranded H07V-R	mm ²		1.5...4	1.5...4
Flexible H07V-K	mm ²	Tab connec. 6.3 and 2.8 mm	0.5...4	0.5...4
Flexible H07V-K and ferrule DIN 46 228/1	mm ²		0.5...4	0.5...4
Flexible H07V-K and ferrule with plastic insul. collar	mm ²		0.5...4	0.5...4
Max. clamping range in mm ² /plug gauge acc. to IEC 60 947-1 Size			0.2...4/A 3	0.2...4/A 3
Continuous current rating of cross-connection 2-pole	A	20	20	20
Continuous current rating of cross-connection multipole	A	20	20	20
Rated data according to UL/CSA				
Voltage/current/conductor size	UL	150 V/10 A/22...12 AWG	150 V/20 A/22...12 AWG	
Voltage/current/conductor size	CSA	300 V/10 A/24...12 AWG	300 V/10 A/24...12 AWG	300 V/10 A/24...12 AWG
Ordering data	Type	Type	Type	Type
	TS 15	TS 15	TS 15	TS 15
	Cat. No.	Cat. No.	Cat. No.	Cat. No.
	Qty.	Qty.	Qty.	Qty.
	KrG			
	PA	0324560000	0324460000	0158760000
	Blue PA			
	PA			
End plate (thickness mm)	Type	Cat. No.	Qty.	Type
	PA	AP (1.5)	0294460000	20
	PA			
	Blue PA			
	HP			
	HP			
	BB			
Partition (thickness mm)	Type	Cat. No.	Qty.	Type
	PA	TW (0.5)	0348260000	50
	HP			
	HP			
Small partition				
Cross-connection				
	Q 2	0369000000	50	Q 2
	Q 3	0369100000	50	Q 3
	Q 4	0369200000	50	Q 4
	Q 10	0369300000	20	Q 10
Switchable cross-connection link				
	VL 2	0446700000	50	VL 2
	VH 10	0446600000	50	VH 10
	BSM 2.5x14	0266800000	100	BSM 2.5x14
Test plug/socket				
	StB	Plug test socket ø 2.3	StB 8.5	0215700000
	PS		PS 2.3	0180400000
Cover				
Insulation sleeves				
	IH 2.8	0386060000	100	IH 2.8
	IH 6.3	0386260000	100	IH 6.3
Marking tags				
	Print			
	DEK	Standard	DEK 6	see "Accessories"
			DEK 6	see "Accessories"
			DEK 6	see "Accessories"
			DEK 6	see "Accessories"
Mounting rails, end brackets, further marking material see "Accessories"				

* Insulation sleeves are to be used for tab connections to maintain the rated voltage.

Feed-through terminals for TS 15

AL 1



6.5/32/21
400 V/16 A/1 mm ²
6 kV/3
0.5...1
0.5...1
24
24
150 V/10 A/24...16 AWG
TS 15 Cat. No. Qty. 0137320000 100
Type Cat. No. Qty.
AP (1.5) 0294420000 20
AP (1.5) 0294460000 20
AP (1.5) 0294480000 20
EP (1.0) 0164100000 100
EP (1.0) 0164500000 100
TW (0.5) 0166800000 50
TW (0.5) 0166800000 50
TSch 4 0363360000 100
TSch 4 0363360000 100
Q 2 0368200000 50
Q 3 0368300000 50
Q 4 0368400000 50
Q 10 0368500000 20
VL 2 0446700000 50
VH 10 0446600000 50
BSM 2.5 x 14 0266800000 100
StB 8.5 0215700000 50
StB 8.5 0215700000 50
PS 2.3 0180400000 20
PS 2.3 0180400000 20
AD 4 0303400000 50
AD 4 0303400000 50
BSKM 25x18 0303300000 100
BSKM 25x18 0303300000 100
DEK 6.5 see "Accessories"
DEK 5 see "Accessories"
DEK 6 see "Accessories"
DEK 6 see "Accessories"

AKZ 1.5 L



5/34.5/25
7 mm / M 2.5 / 3.0 x 0.5
250 V/16 A/1.5 mm ²
4 kV/3
0.4...0.7
1
0.5...2.5
1.5
0.5...1.5
0.5...1.5
0.5...1.5
0.2...2.5 / A 1
24
24
150 V/10 A/24...16 AWG
TS 15 Cat. No. Qty. 0340160000 100
Type Cat. No. Qty.
AP (1.5) 0294420000 20
AP (1.5) 0294460000 20
AP (1.5) 0294480000 20
EP (1.0) 0164100000 100
EP (1.0) 0164500000 100
TW (0.5) 0166800000 50
TW (0.5) 0166800000 50
TSch 4 0363360000 100
TSch 4 0363360000 100
Q 2 0368200000 50
Q 3 0368300000 50
Q 4 0368400000 50
Q 10 0368500000 20
VL 2 0446700000 50
VH 10 0446600000 50
BSM 2.5 x 14 0266800000 100
StB 8.5 0215700000 50
StB 8.5 0215700000 50
PS 2.3 0180400000 20
PS 2.3 0180400000 20
AD 4 0303400000 50
AD 4 0303400000 50
BSKM 25x18 0303300000 100
BSKM 25x18 0303300000 100
DEK 6.5 see "Accessories"
DEK 5 see "Accessories"
DEK 6 see "Accessories"
DEK 6 see "Accessories"

AKZ 4 L



6/35.5/30
9 mm / M 3 / 3.5 x 0.6
250 V/16 A/4/1.5 mm ²
4 kV/3
0.5...1.0
2
0.5...4
1.5...4
0.5...4
0.5...4
0.5...4
0.2...4.0 / A 3
20
20
300 V/20 A/22...12 AWG
300 V/10 A/24...12 AWG
TS 15 Cat. No. Qty. 0334820000 100
TS 15 Cat. No. Qty. 0334860000 100
Type Cat. No. Qty.
AP (1.5) 0294420000 20
AP (1.5) 0294460000 20
AP (1.5) 0294480000 20
EP (1.0) 0164100000 100
EP (1.0) 0164500000 100
TW (0.5) 0348260000 50
TW (0.5) 0348260000 50
TSch 4 0363360000 100
TSch 4 0363360000 100
Q 2 0336400000 50
Q 3 0336500000 50
Q 4 0336600000 50
Q 10 0368600000 20
VL 2 0446700000 50
VH 10 0446600000 50
BSM 2.5 x 14 0266800000 100
StB 8.5 0215700000 50
StB 8.5 0215700000 50
PS 2.3 0180400000 20
PS 2.3 0180400000 20
AD 4 0303400000 50
AD 4 0303400000 50
BSKM 25x18 0303300000 100
BSKM 25x18 0303300000 100
DEK 6.5 see "Accessories"
DEK 5 see "Accessories"
DEK 6 see "Accessories"
DEK 6 see "Accessories"

AKZ 4 LL



6/44/30
250 V/16 A/1.5 mm ²
4 kV/3
0.5...1.5
1.5
0.5...1.5
0.5...1.5
0.2...2.5 / -
20
20
300 V/20 A/22...12 AWG
300 V/10 A/24...12 AWG
TS 15 Cat. No. Qty. 0346460000 100
Type Cat. No. Qty.
AP (1.5) 0294460000 20
AP (1.5) 0294460000 20
EP (1.0) 0164100000 100
EP (1.0) 0164500000 100
TW (0.5) 0348260000 50
TW (0.5) 0348260000 50
TSch 4 0363360000 100
TSch 4 0363360000 100
Q 2 0336400000 50
Q 3 0336500000 50
Q 4 0336600000 50
Q 10 0368600000 20
VL 2 0446700000 50
VH 10 0446600000 50
BSM 2.5 x 14 0266800000 100
StB 8.5 0215700000 50
StB 8.5 0215700000 50
PS 2.3 0180400000 20
PS 2.3 0180400000 20
AD 4 0303400000 50
AD 4 0303400000 50
BSKM 25x18 0303300000 100
BSKM 25x18 0303300000 100
DEK 6.5 see "Accessories"
DEK 5 see "Accessories"
DEK 6 see "Accessories"
DEK 6 see "Accessories"

Feed-through terminals for TS 15

Solder connection
Spring-clip connection
 acc. to DIN 41611 Part 4
Wrap connection
 acc. to DIN/IEC 352 Part 1

AKZ 1.5 T



AKZ 1.5 T

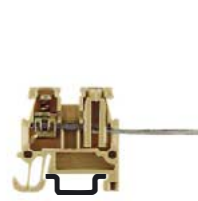

AKZ 1.5 T



AKZ 2.5 K



Dimensions/approvals		UL	UL	UL	UL						
Width/length/height (mm)	with TS 15	5/25/45	5/25/39.5	5/28/44	5/26/46.7						
Pin size		0.8 x 1.6	1 x 1	0.8 x 1.6	0.8 x 1.6						
Insulation stripping length/clamping screw/screwdriver blade		7 mm/M 2.5/3.0 x 0.5	7 mm/M 2.5/3.0 x 0.5	7 mm/M 2.5/3.0 x 0.5	7 mm/M 2.5/3.0 x 0.5						
Rated data		* 035786 = 45 mm									
Rated voltage/current/cross-section		125 V/8 A/1.5 mm ²	125 V/8 A/1.5 mm ²	125 V/8 A/1.5 mm ²	125 V/10 A/2.5 mm ²						
Rated impulse voltage VDE 0110/1.89/pollution severity		2.5 kV/3	2.5 kV/3	2.5 kV/3	2.5 kV/3						
Further technical data											
Tightening torque range	Nm	0.4...0.7	0.4...0.7	0.4...0.7	0.4...0.6						
Torque setting with electric screwdriver type DMS 2		1	1	1	1						
Clampable conductor											
Solid H07V-U	mm ²	0.5...2.5	0.5...2.5	0.5...2.5	0.5...4						
Stranded H07V-R	mm ²	1.5	1.5	1.5	1.5...2.5						
Flexible H07V-K	mm ²	0.5...1.5	0.5...1.5	0.5...1.5	0.5...2.5						
Flexible H07V-K and ferrule DIN 46 228/1	mm ²	0.5...1.5	0.5...1.5	0.5...1.5	0.5...2.5						
Flexible H07V-K and ferrule with plastic insul. collar	mm ²	0.5...1.5	0.5...1.5	0.5...1.5	0.5...2.5						
Max. clamping range in mm ² /plug gauge acc. to IEC 60 947-1	Size	0.13...2.5 / A1	0.13...2.5 / A1	0.13...2.5 / A1	0.13...4.0 / A3						
Continuous current rating of cross-connection 2-pole	A	24	24	24	24						
Continuous current rating of cross-connection multipole	A	24	24	24	24						
Rated data according to UL/CSA											
Voltage/current/conductor size	UL	300 V/10 A/26...14 AWG	300 V/10 A/26...14 AWG	300 V/10 A/26...14 AWG	300 V/10 A/26...14 AWG						
Voltage/current/conductor size	CSA	300 V/10 A/24...16 AWG	300 V/10 A/24...16 AWG	300 V/10 A/24...16 AWG	300 V/10 A/26...10 AWG						
Ordering data		Pin versions									
	0.6 x 0.6	Type	Cat. No.	Qty.							
	1.0 x 1.0	AKZ 1.5 T	0442560000	100	AKZ 1.5 T 0483660000 100						
	0.8 x 1.6 horizont.	AKZ 1.5 T	0357960000	100	AKZ 1.5 T 0357860000 100						
	0.8 x 1.6 vertical	AKZ 1.5 W	0329460000	100	AKZ 1.5 T 0400460000 100						
	0.8 x 2.4 horizontal				AKZ 1.5 T 0400360000 100						
0.8 x 2.4 vertical											
Mounting, horizontal	Mounting, vertical										
End plate (thickness mm)		PA	AP (1.5)	0340560000 50	AP (1.5)	0340560000 50	AP (1.5)	0340560000 50	AP (2.5)	0697260000 50	
Partition (thickness mm)		PA							TW (1.5)	0318560000 20	
Small partition											
Cross-connection		2-pole	Q 2	0368200000 50	Q 2	0368200000 50	Q 2	0368200000 50	Q 2	0368200000 50	
	3-pole	Q 3	0368300000 50	Q 3	0368300000 50	Q 3	0368300000 50	Q 3	0368300000 50		
	4-pole	Q 4	0368400000 50	Q 4	0368400000 50	Q 4	0368400000 50	Q 4	0368400000 50		
	10-pole	Q 10	0368500000 20	Q 10	0368500000 20	Q 10	0368500000 20	Q 10	0368500000 20		
Switchable cross-connection link											
	VL	BS	VH								
Test plug/socket		StB	Plug test socket ø 2.3	StB 8.5	0215700000 50	StB 8.5	0215700000 50	StB 8.5	0215700000 50	StB 8.5	0215700000 50
	PS			PS 2.3	0180400000 20	PS 2.3	0180400000 20	PS 2.3	0180400000 20	PS 2.3	0180400000 20
Marking tags		Print									
	DEK	Standard	DEK 5	see "Accessories"	DEK 5	see "Accessories"	DEK 5	see "Accessories"	DEK 5	see "Accessories"	
Mounting rails, end brackets, further marking material see "Accessories"											

Feed-through terminals for TS 15

for temperature measuring circuits

AKZ 4/TC

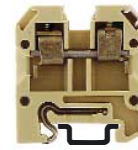

Weidmüller's thermocouple terminals are specially designed for transmitting the smallest voltages in temperature measuring circuits. Special busbars ensure that no false signals occur in the terminal when temperature differences exist in the positive and negative path. This high measuring precision is necessary for, e.g. test beds for aircraft engines, for complicated chemical processes, control systems, etc.

- Busbar material corresponds to thermal and compensating conductors
- Clear thermocouple marking
- 2-pole blocks per thermocouple
- Row width 14 mm, incl. end plate

Configuration of a temperature measuring circuit

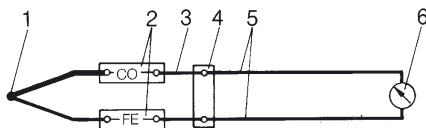

- | | |
|--------------------------|-----------------------------------|
| 1 Thermocouple (sensor) | 4 Reference point |
| 2 Thermocouple terminals | 5 Supply conductors (to and from) |
| 3 Compensating conductor | 6 Measuring device |

The thermocouple terminals displayed in this measurement circuit are used to thermo-electrically transmit thermal e.m.f. of the thermocouple to the reference point and indicating device. Thermocouple terminals are required for the construction of temperature measuring circuits.

Dimensions		
Width/length/height (mm)	with TS 15	14/27/30
Insulation stripping length/clamping screw/screwdriver blade		9 mm/M 3/3.5 x 0.6
Rated data		
Rated voltage/current/cross-section		-/4 mm ²
Further technical data		
Tightening torque range	Nm	0.5...1
Torque setting with electric screwdriver type DMS 2		2
Clampable conductor		
Solid H07V-U	mm ²	0.5...4
Stranded H07V-R	mm ²	1.5...4
Flexible H07V-K	mm ²	0.5...4
Flexible H07V-K and ferrule DIN 46 228/1	mm ²	0.5...2.5
Flexible H07V-K and ferrule with plastic insul. collar	mm ²	0.5...2.5
Plug gauge acc. to IEC 60 947-1	Size	A 3
Continuous current of terminal for conductor size		
Continuous current rating of cross-connection 2-pole	A	
Continuous current rating of cross-connection multipole	A	
Ordering data		
Version		TS 15
for thermocouples	Type J	Cat. No.
Acc. to IEC 584	Type T	Fe - CuNi
(DIN 43710)	Type K	Cu - CuNi
	Type E	NiCr - Ni
		NiCr - CuNi
		Qty.
		1627010000 20
		on demand
		1677130000 20
		on demand

End plate			Cat. No.	Qty.
	AP (thickness 1.5 mm)	PA	0294460000	20
Partition			Cat. No.	Qty.
	TW (thickness 0.5 mm)	PA	0348260000	50

Thermocouple, type J	
Thermocouple acc. to IEC 584 (DIN 43 710)	Busbar
	Constantan (CuNi)
	Iron (Fe)

Marking tags		Print
	Material VO	DEK 5/6
		1789590000 500

Mounting rails, end brackets, further marking material see "Accessories"

Multipole terminal blocks

Screw connection

MK 2/12

MK 10/14

MK 3/12

MK 4/16

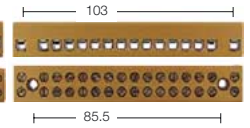
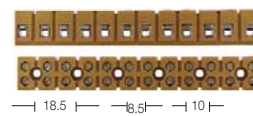
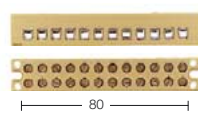

Dimensions/approvals		UL	UL	UL	UL
Width/length/height (mm)		86/15/15	88.5/13.5/12	110/15/16.1	103/17/16
Insulation stripping length/clamping screw/screwdriver blade		5 mm/M 2.5/3.5 x 0.6	6 mm/M 2.5/3.5 x 0.6	5 mm/M 2.5/3.5 x 0.6	5 mm/M 2.5/3.5 x 0.6
Rated data according to IEC 60 947-7-1					
Rated voltage/current/cross-section		125 V/24 A/2.5 mm ²	125 V/24 A/2.5 mm ²	400 V/24 A/2.5 mm ²	400 V/24 A/2.5 mm ²
Rated impulse voltage VDE 0110/1.89/pollution severity		2.5 kV/3	2.5 kV/3	6 kV/3	6 kV/3
Further technical data					
Tightening torque range	Nm	0.4...0.45	0.4...0.45	0.4...0.45	0.4...0.45
Torque setting with electric screwdriver type DMS 2		1	1	1	1
Clampable conductor					
Solid H07V-U	mm ²	0.5...4	0.5...4	0.5...4	0.5...4
Stranded H07V-R	mm ²	1.5...2.5	1.5...2.5	1.5...2.5	1.5...2.5
Flexible H07V-K	mm ²	0.5...2.5	0.5...2.5	0.5...2.5	0.5...2.5
Flexible H07V-K and ferrule DIN 46 228/1	mm ²	0.5...1.5	0.5...1.5	0.5...1.5	0.5...1.5
Flexible H07V-K and ferrule with plastic insul. collar	mm ²	0.5...1.5	0.5...1.5	0.5...1.5	0.5...1.5
Max. clamping range in mm ² /plug gauge acc. to IEC 60 947-1 Size		0.2...4.0 / A 2	0.2...4.0 / A 2	0.2...4.0 / A 2	0.2...4.0 / A 2
Continuous current rating of cross-connection 2-pole		A			
Continuous current rating of cross-connection multipole		A			
Rated data according to UL/CSA					
Voltage/current/conductor size		UL 300 V/10 A/24...12 AWG	150 V/25 A/22...12 AWG	300 V/25 A/22...12 AWG	150 V/20 A/22...12 AWG
Voltage/current/conductor size		CSA 300 V/10 A/24...12 AWG	300 V/10 A/24...12 AWG	300 V/25 A/22...12 AWG	150 V/15 A/22...12 AWG
Ordering data	Version	Type	Cat. No.	Qty.	Type
	2-pole				MK 3/2 KrG 0273820000 100
	3-pole				MK 3/3 KrG 0273920000 50
	4-pole				MK 3/4 KrG 0274020000 50
	4-pole				
	6-pole				MK 3/6 KrG 0274220000 50
	6-pole				
	8-pole				MK 3/8 KrG 0274420000 25
	8-pole				
	10-pole				MK 3/10 KrG 0274620000 20
	12-pole	MK 2/12 PA	0241260000	50	MK 3/12 KrG 0243520000 20
	12-pole				
	14-pole				
	16-pole				MK 4/16 KrG 0244220000 20

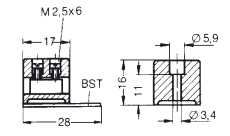
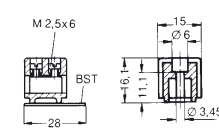
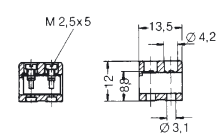
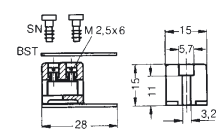

The MK 10/14 can be mounted with glue or with M 3 x 12* screws through the empty terminal point aperture

*DIN EN ISO 1207

Soldering strip/expansion rivet		MF 2/12		SN	
		0241760000	50	0200100000	500
Marking strips		printed		BSTb 28/12 0245700000 50	
	1 ...	bottom		BSTb 28/8 0290200000 50	
		BSTb 28/12 0278500000 50		BSTb 28/6 0290000000 50	
		top		BSTb 28/4 0289800000 50	
	unprinted	BSTo 28/12 0245600000 50		BSTo 28/12 0245800000 50	
				BSTo 28/8 0284700000 50	
				BSTo 28/6 0289500000 50	
				BSTo 28/4 0289300000 50	

Printed on top on request

SAK-series

Multipole terminal blocks

Screw/tab connection

MK 5/2

KS 2...10

BK 2...12

MK 6/2...6/6



Dimensions/approvals

Width/length/height (mm)	40/18/15.5	see table below	see table below	see table below
--------------------------	------------	-----------------	-----------------	-----------------

Insulation stripping length/clamping screw/screwdriver blade	5 mm/M 2.5/3.5 x 0.6	8 mm/M 3/4.0 x 0.8	8 mm/M 3/4.0 x 0.8	9 mm/M 4/4.0 x 0.8
--	----------------------	--------------------	--------------------	--------------------

Rated data according to IEC 60 947-7-1

Rated voltage/current/cross-section	500 V/24 A/2.5 mm ²	500 V/24 A/2.5 mm ²	400 V/32 A/4 mm ²	690 V/41 A/6 mm ²
Rated impulse voltage VDE 0110/1.89/pollution severity	6 kV/3	6 kV/3	6 kV/3	8 kV/3

Further technical data

Tightening torque range	Nm 0.4...0.45	0.5...0.7	0.5...0.7	1.2...2.0
Torque setting with electric screwdriver type DMS 2	1	2	2	4

Clampable conductor

Solid H07V-U	mm ² 0.5...4	0.5...4	0.5...4	0.5...6
Stranded H07V-R	mm ² 1.5...2.5	1.5...2.5	1.5...4	1.5...6
Flexible H07V-K	mm ² 0.5...2.5	0.5...2.5	0.5...4	0.5...6
Flexible H07V-K and ferrule DIN 46 228/1	mm ² 0.5...1.5	0.5...1.5	0.5...4	0.5...4
Flexible H07V-K and ferrule with plastic insul. collar	mm ² 0.5...1.5	0.5...1.2	0.5...4	0.5...4
Max. clamping range in mm ² /plug gauge acc. to IEC 60 947-1	Size 0.2...4.0 / A 2	0.2...4.0 / A 2	0.33...4.0 / A 3	0.33...6.0 / A 3

Rated data according to UL/CSA

Voltage/current/conductor size	UL	300 V/20 A/22...12 AWG	300 V/10 A/22...12 AWG	300 V/30 A/22...10 AWG
Voltage/current/conductor size	CSA	300 V/25 A/24...12 AWG	300 V/10 A/22...12 AWG	300 V/40 A/22...10 AWG

Ordering data

Versions

Ordering data	Versions	Type	Cat. No.	Qty.	Type	Cat. No.	Qty.	Type	Cat. No.	Qty.	Type	Cat. No.	Qty.
	2-pole	MK 5/2 KrG	0243820000	100	KS 2 KrG ²⁾	0134420000	100	BK 2 KrG	0624720000	50	MK 6/2 KrG	0620420000	50
	3-pole							BK 3 KrG	0624920000	50	MK 6/3 KrG	0620320000	50
	4-pole				KS 4 KrG ²⁾	0140320000	50	BK 4 KrG	0625120000	50	MK 6/4 KrG	0620220000	20
	6-pole							BK 6 KrG	0625220000	50	MK 6/6 KrG	0620120000	20
	6-pole												
	8-pole												
	8-pole												
	10-pole				KS 10 KrG ²⁾	0141620000	20						
	12-pole	Cover			Cover			BK 12 KrG	0625320000	50			
	12-pole	D2 (for MK 5/2)	0244060000	50	D 2 (for KS 2)	0134500000	100						
		D2 (for MK 5/2)	0244060000	50	D 4 (for KS 4)	0140500000	50						
					D 6 (for KS 6)	0140800000	50						
					D 10 (for KS 10)	0141800000	20						



Cover D 2
(for MK 5/2)



Cover D 4
(for KS 4)

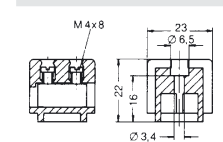
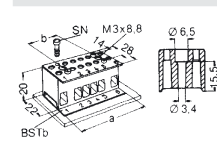
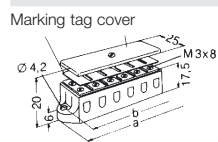
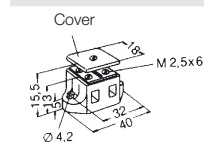

Dimensions

Type	a	b
KS 2	42	32
KS 4	66	56
KS 6	90	80
KS 10	138	128

Dimensions

Type	a	b
BK 2	20	-
BK 3	31	11
BK 4	38	18
BK 6	52	32
BK 12	92	72.5

Dimens. Length/attach. dim.

Type	KRG
MK 6/2	23.5
MK 6/3	36.5
MK 6/4	49.5
MK 6/6	75.5

Expansion rivet

--	--	--	--	--	--	--	--	--	--	--	--	--	--

Marking strips

Marking strips	printed	1 ...	ELSo 2	0142800000	50	BSTb 28/2	0203600000	50	BSTb 17/6	0304600000	50
	unprinted		ELSo 4	0142900000	50	BSTb 28/3	0203800000	50			
			ELSo 6	0143000000	50	BSTb 28/4	0197300000	50			
			ELSo 10	0143500000	50	BSTb 28/6	0197500000	50			
						BSTb 28/12	0198800000	50			
						BSTo 28/2	0203500000	50			
						BSTo 28/3	0203700000	50			
						BSTo 28/4	0197200000	50			
						BSTo 28/6	0197400000	50			
						BSTo 28/12	0198700000	50			

Mounting rails, end brackets, further marking material see "Accessories"

1) Projecting length = 1 mm. To be considered for the last terminal in a row!
Printed on top on request
2) Please order cover and marking strips separately.

Multipole terminal blocks

Screw, solder, tab
connection
Modular design

AKB 4

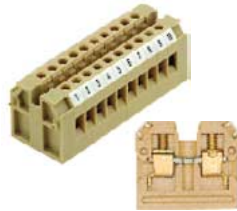

AKZ 2.5

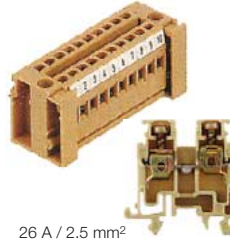

ASK 1



Max. technical data

Dimensions/approvals	AKB 4	AKZ 2.5	ASK 1
Width/length/height (mm)	6/27/23	5/25.5/26.5	8/58/30.5
Insulation stripping length/clamping screw/screwdriver blade	9 mm/M 3/3.5 x 0.6	7 mm/M 2.5/3 x 0.5	9 mm/M 3/3.5 x 0.6
Rated data according to IEC 60 947-7-1			
Rated voltage/current/cross-section	400 V/32 A/4 mm ²	250 V/24 A/2.5 mm ²	500 V/6.3 A/4 mm ²
Rated impulse voltage VDE 0110/1.89/pollution severity	6 kV/3	4 kV/3	6 kV/3
Further technical data			
Tightening torque range Nm	0.5...1.0	0.4...0.6	0.5...1.0
Torque setting with electric screwdriver type DMS 2	2	1	2
Clampable conductor			
Solid H07V-U mm ²	0.5...6	0.5...4	0.5...4
Stranded H07V-R mm ²	1.5...4	1.5...2.5	1.5...4
Flexible H07V-K mm ²	0.5...4	0.5...2.5	0.5...4
Flexible H07V-K and ferrule DIN 46 228/1 mm ²	0.5...4	0.5...2.5	0.5...2.5
Flexible H07V-K and ferrule with plastic insul. collar mm ²	0.5...4	0.5...2.5	0.5...2.5
Max. clamping range in mm ² /plug gauge acc. to IEC 60 947-1 Size	0.33...4.0 / A3	0.13...4.0 / A3	0.13...4.0 / A3
Continuous current rating of cross-connection 2-pole A	32	24	(QB 2...4) 10
Continuous current rating of cross-connection multipole A	32	24	
Rated data according to UL/CSA			
Voltage/current/conductor size UL	300/250 V/27 A/22...12 AWG	300 V/10 A/22...12 AWG	300 V/10 A/22...12 AWG
Voltage/current/conductor size CSA	300 V/10 A/22...12 AWG	300 V/10 A/26...10 AWG	300 V/6.3 A/26...12 AWG
Ordering data			
	Type Cat. No. Qty.	Type Cat. No. Qty.	Type Cat. No. Qty.
PA	AKB 4 PA 0321560000 100	AKZ 2.5 0697160000 100	ASK 1 PA 0376960000 100
Blue PA	0321580000 100	AKZ 2.5 0697180000 100	
	Direct mounting with BB 1 please order separately	Direct mounting with BB 4 please order separately	(for G fuse inserts 5x 20 without indicator)
End plate/attachment bracket (thickness mm)			
AP	BB 1 (7) 0320560000 50	BB 4 (7.5) 0697560000 50	
Blue PA	BS M 3 x 15 0359000000 100		
		AP (2.5) 0697360000 50	AP (1.5) 0380360000 20
		AP (2.5) 0697380000 50	
Partition (thickness mm)			
	TW PA (0.5) 0348260000 50		
Small partition			
	TSch 4 0363360000 100		
Cross-connection			
Q 3 QB 4	Q 2 0336400000 50	Q 2 0368200000 50	QB 2 ¹⁾ 0461100000 50
	Q 3 0336500000 50	Q 3 0368300000 50	QB 3 ¹⁾ 0461200000 50
	Q 4 0336600000 50	Q 4 0368400000 50	QB 4 ¹⁾ 0461300000 50
	Q 10 0368600000 20	Q 10 0368500000 20	
Switchable cross-connection link			
VL BS VH	VL 2 0446700000 50		
	VH 10 0446600000 50		
	BS M 2.5x14 0266800000 100		
Test plug/socket			
PS StB	StB 8.5 0215700000 50	StB 8.5 0215700000 50	
	PS 2.3 0180400000 20	PS 2.3 0180400000 20	
Cover/contact sleeve			
K sleeve	AD 4 0303400000 50		
	BSKM2.5x18 0303300000 100		K sleeve 0553300000 100
Marking tags			
DEK Standard	DEK 6 see "Accessories"	DEK 5 see "Accessories"	DEK 6.5 see "Accessories"
Mounting rails, end brackets, further marking material see "Accessories"			

¹⁾ The conductor cross-section is reduced to max. 2.5 mm² when QB is used.

* With contact sleeve 19 A

Feed-through terminals

Screw connection
Solder connection
Tab connection
Spring-clip connection
 acc. to DIN 41 611 Part 4
Wrap connection
 acc. to DIN/IEC 352 Part 1

AKA 2.5



ADK 1



ADK 1 F ADK 3 F



ADK 1 S



Dimensions/approvals		UL	UL	UL	UL
Width/length/height with Pins (mm)	6/20/31	6/22/36.5	6/22/36.5	6/22/36.5	6/22/36.5
Length solder tag/pin (mm)	7,8	8,4	8,5/7,5	8,4	8,4
Insulation stripping length/clamping screw/screwdriver blade	9 mm/M 2.5/3.5 x 0.6	9 mm/M 3.5/3.5 x 0.6	11 mm/M 2.5/3.5 x 0.6	-	-
Rated data					
Rated voltage*/current/cross-section	400 V/20 A/2.5/1.5 mm ²	400 V/16 A/4/1.5 mm ²	400 V/20 A/2.5/1.5 mm ²	400 V/16 A/2.5/1.5/1 mm ²	400 V/16 A/2.5/1.5/1 mm ²
Rated impulse voltage VDE 0110/1.89/pollution severity	6 kV/3	6 kV/3	6 kV/3	6 kV/3	6 kV/3
Further technical data					
Tightening torque range	Nm 0.4	0.5...1.0	0.4...0.6	-	-
Torque setting with electric screwdriver type DMS 2	1	2	1	-	-
Clampable conductor					
Solid H07V-U	mm ² 0.5...2.5	0.5...4	0.5...2.5		
Stranded H07V-R	mm ² 1.5...2.5	1.5...4	1.5...2.5		
Flexible H07V-K	mm ² 0.5...2.5	0.5...4	0.5...2.5		
Flexible H07V-K and ferrule DIN 46 228/1	mm ² 0.5...1.5	0.5...2.5	0.5...1.5		
Flexible H07V-K and ferrule with plastic insul. collar	mm ² 0.5...1.5	0.5...2.5	0.5...1.5		
Max. clamping range in mm ² /plug gauge acc. to IEC 60 947-1	Size 0.13...2.5 / A2	0.13...2.5 / A3	0.13...2.5 / A2	0.5...2.5 / -	0.5...2.5 / -
Continuous current rating of cross-connection 2-pole	A 10	10			
Continuous current rating of cross-connection multipole	A 10	10			
Rated data according to UL/CSA					
Voltage/current/conductor size	UL 300 V/20 A/26...12 AWG	300 V/10 A/26...12 AWG	300 V/20 A/26...14 AWG	300 V/18 A/12 AWG max.	300 V/18 A/12 AWG max.
Voltage/current/conductor size	CSA 300 V/10 A/24...12 AWG	300 V/15 A/26...12 AWG	300 V/15 A/22...14 AWG	300 V/3 A/-	300 V/3 A/-
Ordering data					
Version		Cat. No.	1.5 Qty.	2.5 Qty.	1.5 Qty.
for plate thckn. mm					
PA		0300720000	100		
KrG					
Pin 1.0x1.0					
Pin 0.8x1.6					
FS 1x6.3 slotted/0.8x2.8					
12-pole PA					0476160000 100 0478560000 100
End plate (thickness mm)		Type	Cat. No.	Qty.	Type
	KrG	AP (3)	0162520000	100	AP (3)
	PA				0476260000 50
	EP				AP (3) 0360000000 20
Spacer (thickness mm)					
	KrG	ZP (1.5)	0240720000	50	
	KrG	ZP (2.5)	0288520000	20	
Partition (thickness mm)					
		TW (0.5)	0442300000	50	TW (0.5) 0442300000 50
					TW (0.5) 0442300000 50
Test plug/socket					
	StB	PS 2.3	0180400000	20	
	Plug test socket ø 2.3				
	PS				
Fuse pin/insulation sleeve/expansion rivet					
		SST 1.2	0306600000		SST 1.2 030660
					IH 2.8 0386060000 100
					IH 2.8 0386060000 100
					IH 2.8 0386060000 100
					IH 6.3 0386260000 100
					IH 6.3 0386260000 100
Marking tags					
	Print	DEK	Standard	DEK 6	see "Accessories"
		DEK	Standard	DEK 6	see "Accessories"
		DEK	Standard	DEK 6	see "Accessories"
		DEK	Standard	DEK 6	see "Accessories"
Mounting rails, end brackets, further marking material see "Accessories"					

* Insulation sleeves are to be used for tab connections to maintain the rated voltage.

Feed-through terminals

ADK 1 T



6/22/50.5
19.5...21.9
9 mm/M 3/3.5 x 0.6
400 V/8 A/4 mm ²
6 kV/3
0.5...1.0
2
0.5...4
1.5...4
0.5...4
0.5...2.5
0.5...2.5
0.13...4.0 / A3
10
300/250 V/10 A/26...12 AWG
300 V/15 A/26...12 AWG
1.5 Qty. 2.5 Qty.
0372260000 100
0366360000 100

Type	Cat. No.	Qty.
AP (3)	0476260000	50

TW (0.5)	0442300000	50
----------	-------------------	----

PS 2.3	0180400000	20
StB 8.5	0215700000	50

SST 1.2	0306600000	
---------	-------------------	--

DEK 6	see "Accessories"	
-------	-------------------	--

AKZ 2.5 K

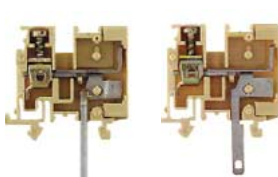

5/26/45.5
22.4...23.6
7 mm/M 2.5/3.0 x 0.5
250 V/8 A/2.5 mm ²
4 kV/3
0.4...0.6
1
0.5...2.5
1.5...2.5
0.5...2.5
0.5...2.5
0.5...2.5
0.13...2.5 / A2
10
300/250 V/10 A/22...12 AWG
300 V/10 A/26...10 AWG
Cat. No. Qty.
0109160000 solder tag 100
0108960000 100

Type	Cat. No.	Qty.
AP (3)	0697260000	50

TW (1.5)	0318560000	20
----------	-------------------	----

PS 2.3	0180400000	20
StB 8.5	0215700000	50

IH 2.8	0386060000	100
--------	-------------------	-----

DEK 5	see "Accessories"	
-------	-------------------	--

ADK 1 FT



6/22/52
24
11 mm/M 2.5/3.5 x 0.6
250 V/10 A/2.5 mm ²
4 kV/3
0.4...0.6
1
0.5...2.5
1.5...2.5
0.5...2.5
0.5...1.5
0.5...1.5
0.33...2.5 / A2
10
300 V/3 A/22...14 AWG
Cat. No. 1.5 Qty.
0176960000 100

Type	Cat. No.	Qty.
AP (3)	0476260000	50

TW (0.5)	0442300000	50
----------	-------------------	----

SST 1.2	0306600000	
---------	-------------------	--

DEK 6	see "Accessories"	
-------	-------------------	--

MK 2/12

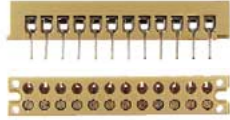

86/15/23
8
5
63 V/20 A/2.5/1.5 mm ²
1.5 kV/3
0.4...0.45
1
0.5...2.5
1.5...2.5
0.5...2.5
0.5...2.5
0.5...2.5
0.2...2.5 / A2
10
300 V/10 A/24...12 AWG
300 V/10 A/24...12 AWG
Cat. No. Qty.
0241460000 50

Type	Cat. No.	Qty.
AP (3)	0476260000	50

TW (0.5)	0442300000	50
----------	-------------------	----

SN	0200100000	500
----	-------------------	-----

BSTb 28/12	024570...	50
BSTo 28/12	024560...	50

Rack-mounted interface systems

TOP 1.5 F/32



SP 10 FF²⁾ SP 10 LF³⁾



SP 60 FF²⁾ SP 60 LF³⁾



SP 90 FF²⁾ SP 90 LF³⁾

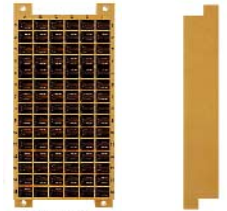

Dimensions

Width/length/height (mm)		40.2/110.6/29.5	42/46.5/170/28	40/45.5/162.5/110	40/45.5/228.5/110
Hole spacing/mounting dimensions	mm	101.6/20.3	147	151/90	217/90
Insulation stripping length/clamping screw/screwdriver blade		10 mm/M 2.5/3.5 x 0.6			

Rated data

Rated voltage [*] /current/cross-section		250 [*] V/6 A/1.5/1 mm ²	1000 [*] V/16 A/2.5/1.5 mm ²	400 [*] V/16 A/2.5/1.5 mm ²	400 [*] V/16 A/2.5/1.5 mm ²
Rated impulse voltage VDE 0110/1.89/pollution severity		4 kV/3	6 kV/3	6 kV/3	6 kV/3

Further technical data

Tightening torque range	Nm	0.4...0.7			
Torque setting with electric screwdriver type DMS 2		1			

Clampable conductor

Solid H07V-U	mm ²	0.5...2.5			
Stranded H07V-R	mm ²	1.5			
Flexible H07V-K	mm ²	0.5...1.5			
Flexible H07V-K and ferrule DIN 46 228/1	mm ²	0.5...1.5			
Flexible H07V-K and ferrule with plastic insul. collar	mm ²	0.5...1.5			
Plug gauge acc. to IEC 60 947-1	Size	A1			

Ordering data

	Version	Type	Cat. No.	Qty.	Type	Cat. No.	Qty.	Type	Cat. No.	Qty.	Type	Cat. No.	Qty.
Pin 1.0 x 1.0	PA	TOP 1.5 F/32	0443160000 ¹⁾	5									
Pin 0.8 x 2.8 (push-on), unprinted	PA												
Pin 0.8 x 2.8 (push-on), printed, 1...32	PA												
Pin 0.8 x 2.8 (push-on), printed, 1...32, blue	PA												
6 x plug (6.3 x 0.8)	KrG				SP 10 FF	0456220000	10	SP 60 FF ⁴⁾	0340320000	1	SP 90 FF ^{**}	0248120000	1
6 x plug (6.3 x 0.8), blue	KrG							SP 60 FF ⁴⁾	0340370000	1			
6 x plug (6.3 x 0.8), bzw. 12 x 2.8 x 0.8 slotted	KrG										SP 90 FF ^{**}	0608920000	1
6 x plug (6.3 x 0.8), bzw. 12 x 2.8 x 0.8 slotted, blue	KrG												
3 x plug (6.3 x 0.8) / 1 x solder per pole	KrG							SP 60 LF ⁴⁾	0343720000	1	SP 90 LF ^{**}	0248220000	1
3 x plug (6.3 x 0.8) / 1 x solder per pole, blue	KrG							SP 60 LF ⁴⁾	0343770000	1			
3 x plug (6.3 x 0.8 bzw. 6 x 2.8 x 0.8) / 1 x solder	KrG							SP 60 LF ⁵⁾	0124520000	1			
3 x plug (6.3 x 0.8 bzw. 6 x 2.8 x 0.8) / 1 x solder, blue	KrG							SP 60 LF ⁵⁾	0124570000	1			
2 x direct connection, 1 x Pin 0.8 x 1.6	PA										printed:		

Insulation sleeves

Type	Cat. No.	Qty.	Type	Cat. No.	Qty.	Type	Cat. No.	Qty.	Type	Cat. No.	Qty.
IH 2.8	0386060000	100	IH 2.8	0386060000	100	IH 2.8	0386060000	100	IH 2.8	0386060000	100
			IH 6.3	0386260000	100	IH 6.3	0386260000	100	IH 6.3	0386260000	100

Marking tags

	Print			
dekafix	for group markers		FW 5	see "Accessories"

Mounting rails, end brackets, further marking material see "Accessories"

* Insulation sleeves are to be used for tab connections to maintain the rated voltage.

¹⁾ Rated voltage 125 V

²⁾ FF = Tab - Tab
³⁾ LF = Solder - Tab

Rack-mounted interface systems

RV 8/8 long



RV 8/8 short



RV 8/9 long

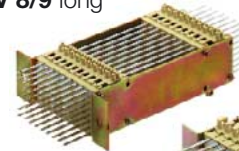

RV 8/9 short



Technical data acc. to VDE

Pin versions (intern)

0.8 x 2.4/1 x 1

0.8 x 2.4/0.8 x 2.4

Plug adapter



1-pole

for connection of solid and flexible conductors from 0.75 to 1.5 mm² directly on to the pins of the interface system.

125 V/-/-			125 V/-/-		
Type	Cat. No.	Qty.	Type	Cat. No.	Qty.
	0468860000	1		0467160000	1
	0468960000	1		0467260000	1
Type	Cat. No.	Qty.	Type	Cat. No.	Qty.
DSA 1	0576060000	50	DSA 1	0576060000	50

105 V/-/-			125 V/-/-		
Type	Cat. No.	Qty.	Type	Cat. No.	Qty.
	0498960000	1		0444060000	1
	0499060000	1		0545960000	1
with shield pins			with shield pins		
Type	Cat. No.	Qty.	Type	Cat. No.	Qty.
DSA 1	0576060000	50	DSA 1	0576060000	50

RV 8/20 short



RV 8/56 short

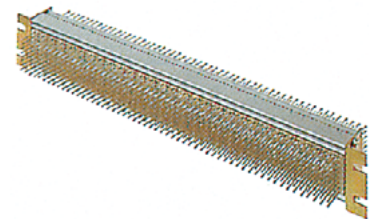

Technical data acc. to VDE

Pin versions (internal)

0.8 x 2.4/1 x 1

0.8 x 2.4/0.8 x 2.4

Additional versions on request

125 V/-/-		
Cat. No.	Qty.	
0544460000	1	

125 V/-/-		
Cat. No.	Qty.	
0462260000	1	
0533060000	4	

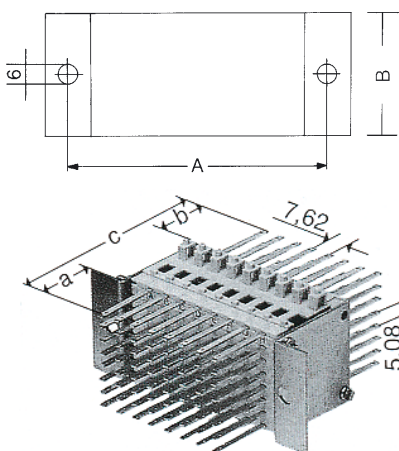

Type	Size A		Size B	
	in mm		in mm	
RV 8/8 K	81	40.64		
RV 8/9 K	89	40.64		
RV 8/8 L	93	40.64		
RV 8/9 L	100	40.64		
RV 8/20 K	187,62/31.5	63		
RV 8/56 K	460/31.5	63		

(K = short/L = long)

Cat. No.	RV	a	b	c
0468860000	8/8 L	26	20	200
0468960000	8/8 L	26	26	206
0467160000	8/8 K	26	20	84
0467260000	8/8 K	26	26	89
0119360000	8/20 K	26	20	84
0544460000	8/20 K	26	26	89
0462260000	8/56 K	26	20	84
0533060000	8/56 K	26	26	89

Mounting rails, end brackets, further marking material see "Accessories"

SAK-series