

GPS/GNSS Low-Noise Amplifiers

General Description

The MAX2686/MAX2688 low-noise amplifiers (LNAs) are designed for GPS L1, Galileo, and GLONASS applications. Designed in Maxim's advanced SiGe process, the devices achieve high gain and ultra-low-noise figure while maximizing the input-referred 1dB compression point and the 3rd-order intercept point. The MAX2686 provides a high gain of 19dB. The MAX2688 supplies 15dB of gain while attaining higher linearity.

The devices operate from a +1.6V to +3.3V single supply. The optional shutdown feature in the devices reduces the supply current to less than 10 μ A. The devices are available in a very small, lead-free, RoHS-compliant, 0.86mm x 0.86mm x 0.65mm wafer-level package (WLP).

Applications

Automotive Navigation
Telematics (Asset Tracking and Management)
Personal Navigation Devices (PNDs)
Cellular Phones with GPS
Notebook PCs/Ultra-Mobile PCs
Recreational, Marine Navigation
Avionics
Watches
Digital Cameras

Features

- ◆ High-Power Gain: 19dB (MAX2686)
- ◆ Ultra-Low-Noise Figure: 0.75dB (MAX2686)
- ◆ Integrated 50 Ω Output Matching Circuit
- ◆ Low Supply Current: 4.1mA
- ◆ Wide Supply Voltage Range: 1.6V to 3.3V
- ◆ Low Bill of Materials: One Inductor, Two Capacitors
- ◆ Small Footprint: 0.86mm x 0.86mm
- ◆ Thin Profile: 0.65mm
- ◆ 0.4mm-Pitch Wafer-Level Package (WLP)

Ordering Information

PART	TEMP RANGE	PIN-PACKAGE
MAX2686EWS+T	-40°C to +85°C	4 WLP
MAX2688EWS+T	-40°C to +85°C	4 WLP

+ Denotes a lead(Pb)-free/RoHS-compliant package.
T = Tape and reel.

Typical Application Circuit

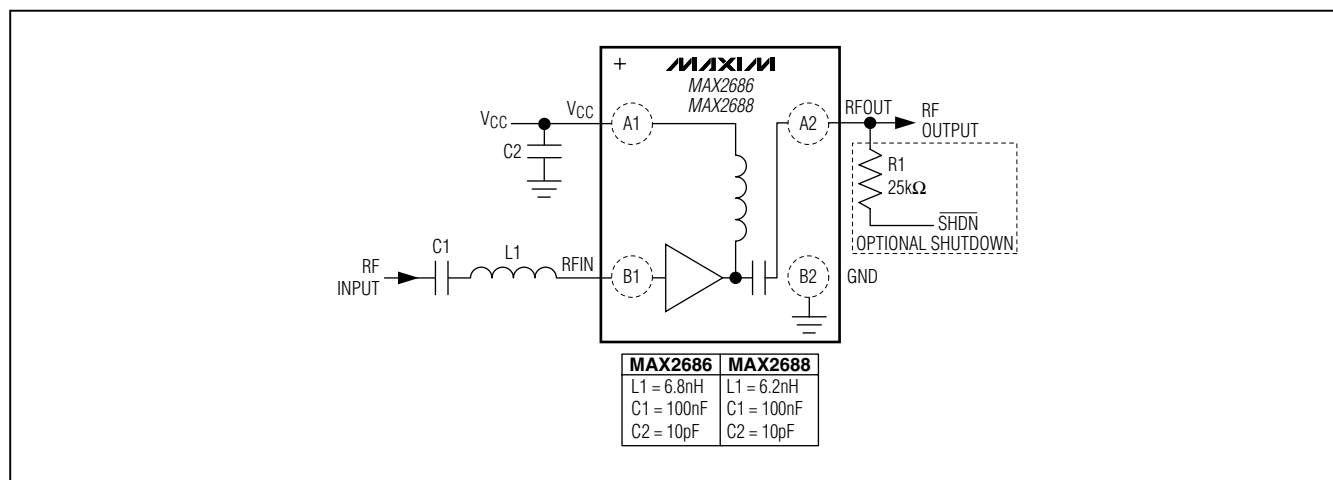

GPS/GNSS Low-Noise Amplifiers

ABSOLUTE MAXIMUM RATINGS

VCC to GND.....	-0.3V to +3.6V	Operating Temperature Range.....	-40°C to +85°C
Other Pins to GND	-0.3V to (+ Operating VCC + 0.3V)	Junction Temperature	+150°C
Maximum RF Input Power	+5dBm	Storage Temperature Range.....	-65°C to +160°C
Continuous Power Dissipation (TA = +70°C)		Lead Temperature (soldering, 10s)	Reflow Profile (Note 1)
4-Bump WLP (derates 9.7mW/°C above +70°C)	776mW	Soldering Temperature (reflow)	+260°C
Maximum Current into RF Input	10mA		

Note 1: Refer to Application Note 1891: *Wafer-Level Packaging (WLP) and Its Applications*.

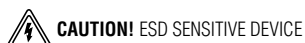

Stresses beyond those listed under "Absolute Maximum Ratings" may cause permanent damage to the device. These are stress ratings only, and functional operation of the device at these or any other conditions beyond those indicated in the operational sections of the specifications is not implied. Exposure to absolute maximum rating conditions for extended periods may affect device reliability.

DC ELECTRICAL CHARACTERISTICS

(MAX2686/MAX2688 EV kit, VCC = 1.6V to 3.3V, TA = -40°C to +85°C, no RF signals are applied. Typical values are at VCC = 2.85V and TA = +25°C, unless otherwise noted.) (Note 2)

PARAMETER	CONDITIONS	MIN	TYP	MAX	UNITS
Supply Voltage		1.6	2.85	3.3	V
Supply Current	$\overline{\text{SHDN}}$ = high	MAX2686	4.1		mA
		MAX2688	4.1		
	Shutdown mode, $\overline{\text{SHDN}}$ = low				10
Digital Input Logic-High	(Note 3)	1.2			V
Digital Input Logic-Low	(Note 3)			0.45	V

AC ELECTRICAL CHARACTERISTICS

(MAX2686/MAX2688 EV kit, VCC = 1.6V to 3.3V, TA = -40°C to +85°C, fRFIN = 1575.42MHz. Typical values are at VCC = 2.85V and TA = +25°C, unless otherwise noted.) (Note 2)

PARAMETER	CONDITIONS	MIN	TYP	MAX	UNITS
RF Frequency	L1 band		1575.42		MHz
Power Gain	VCC = 2.85V (Note 4)	MAX2686	14.7	19	dB
		MAX2688	11.9	15.4	
	VCC = 1.6V	MAX2686	14.4	18.9	
		MAX2688	11.6	15.3	
Noise Figure	VCC = 1.6V to 3.3V	MAX2686	0.75		dB
		MAX2688	0.8		
In-Band 3rd-Order Input Intercept Point	(Note 5)	MAX2686	-3		dBm
		MAX2688	+4		
Out-of-Band 3rd-Order Input Intercept Point	(Note 6)	MAX2686	0		dBm
		MAX2688	+7		
Input 1dB Compression Point	(Note 7)	MAX2686	-10		dBm
		MAX2688	-6		
Input Return Loss			8.5		dB

GPS/GNSS Low-Noise Amplifiers

MAX2686/MAX2688

AC ELECTRICAL CHARACTERISTICS (continued)

(MAX2686/MAX2688 EV kit, $V_{CC} = 1.6V$ to $3.3V$, $T_A = -40^{\circ}C$ to $+85^{\circ}C$, $f_{RFIN} = 1575.42MHz$. Typical values are at $V_{CC} = 2.85V$ and $T_A = +25^{\circ}C$, unless otherwise noted.) (Note 2)

PARAMETER	CONDITIONS	MIN	TYP	MAX	UNITS
Output Return Loss			15		dB
Reverse Isolation			40		dB

Note 2: Min and max limits guaranteed by test at $T_A = +25^{\circ}C$ and guaranteed by design and characterization at $T_A = -40^{\circ}C$ and $T_A = +85^{\circ}C$, unless otherwise noted.

Note 3: Min and max limits guaranteed by test at $T_A = +25^{\circ}C$.

Note 4: Min limit guaranteed by design and characterization.

Note 5: Measured with the two tones located at 1MHz and 2MHz offset from the center of the GPS band with -27dBm/tone for the MAX2686 and -24dBm/tone for the MAX2688.

Note 6: Measured with input tones at 1713MHz (-27dBm) and 1851MHz (-39dBm).

Note 7: Measured with a tone located at 5MHz offset from the center of the GPS band.

Typical Operating Characteristics

(MAX2686/MAX2688 EV kit. Typical values are at $V_{CC} = 2.85V$, $T_A = +25^{\circ}C$, and $f_{RFIN} = 1575.42MHz$, unless otherwise noted.)

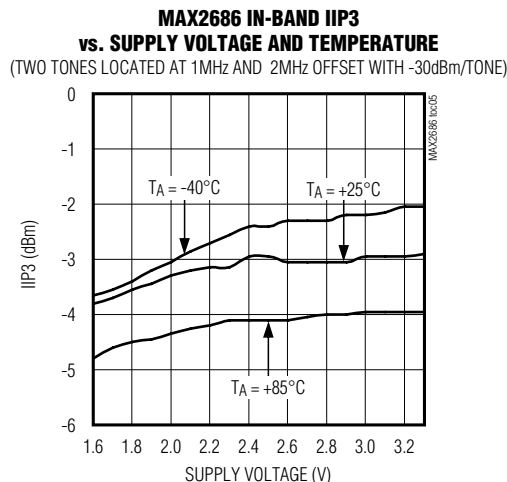
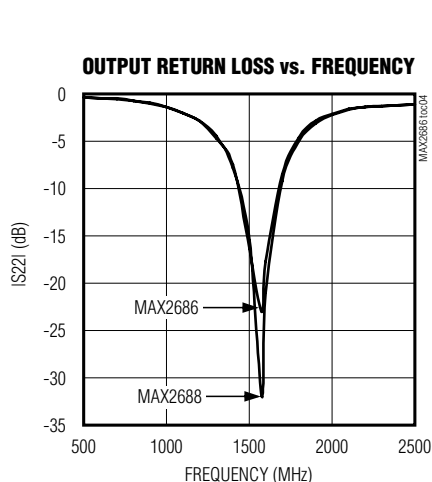
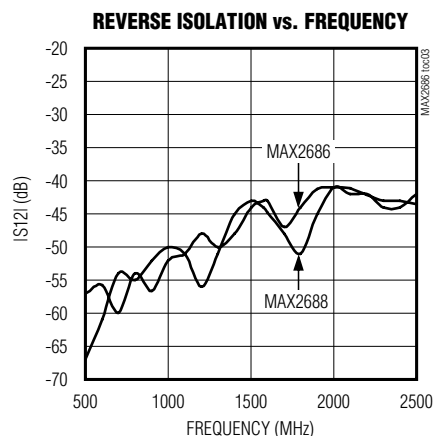
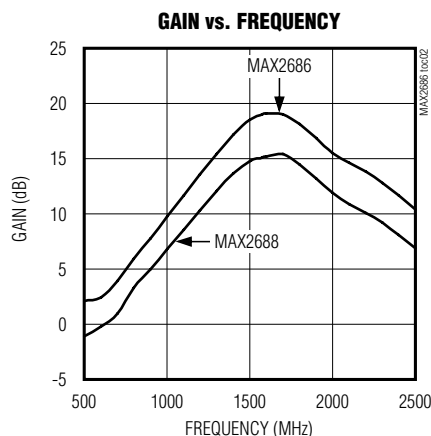
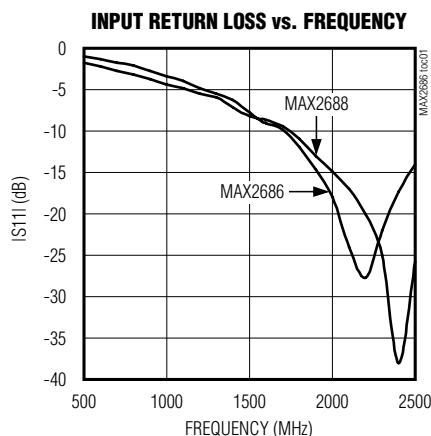

GPS/GNSS Low-Noise Amplifiers

Typical Operating Characteristics (continued)

(MAX2686/MAX2688 EV kit. Typical values are at $V_{CC} = 2.85V$, $T_A = +25^\circ C$, and $f_{RFIN} = 1575.42MHz$, unless otherwise noted.)

MAX2688 IN-BAND IIP3 vs. SUPPLY VOLTAGE AND TEMPERATURE
(TWO TONES LOCATED AT 1MHz AND 2MHz OFFSET WITH -30dBm/TONE)

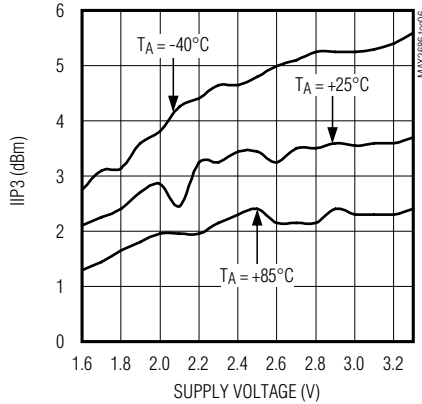

MAX2686 OUT-OF-BAND IIP3 vs. SUPPLY VOLTAGE AND TEMPERATURE
(TONE 1 AT 1713MHz, -27dBm; TONE 2 AT 1851MHz, -39dBm)

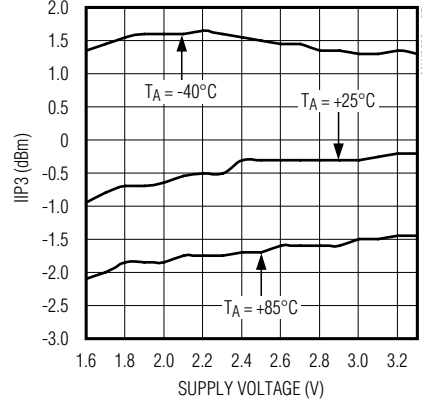

MAX2688 OUT-OF-BAND IIP3 vs. SUPPLY VOLTAGE AND TEMPERATURE
(TONE 1 AT 1713MHz, -27dBm; TONE 2 AT 1851MHz, -39dBm)

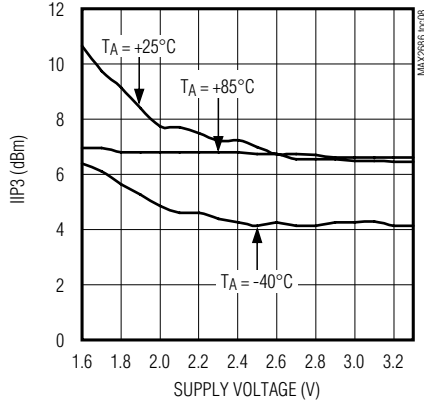

MAX2686 INPUT P1dB COMPRESSION vs. SUPPLY VOLTAGE AND TEMPERATURE

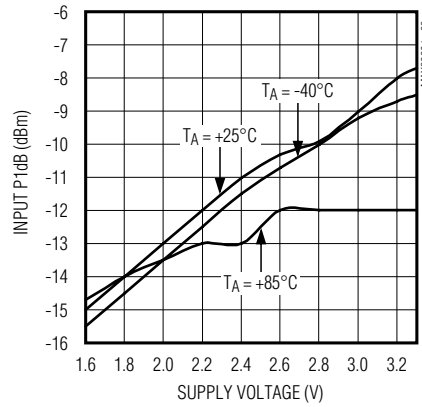

MAX2688 INPUT P1dB COMPRESSION vs. SUPPLY VOLTAGE AND TEMPERATURE

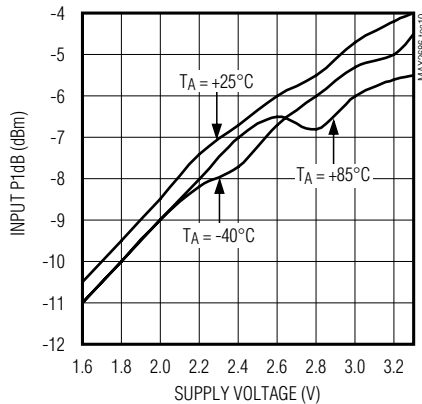

1dB GAIN DESENSE vs. BLOCKER FREQUENCY

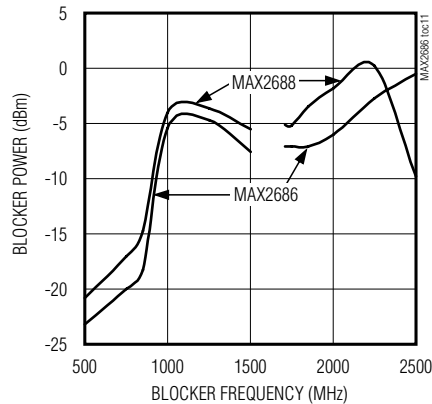

GPS/GNSS Low-Noise Amplifiers

MAX2686/MAX2688

Bump Configuration

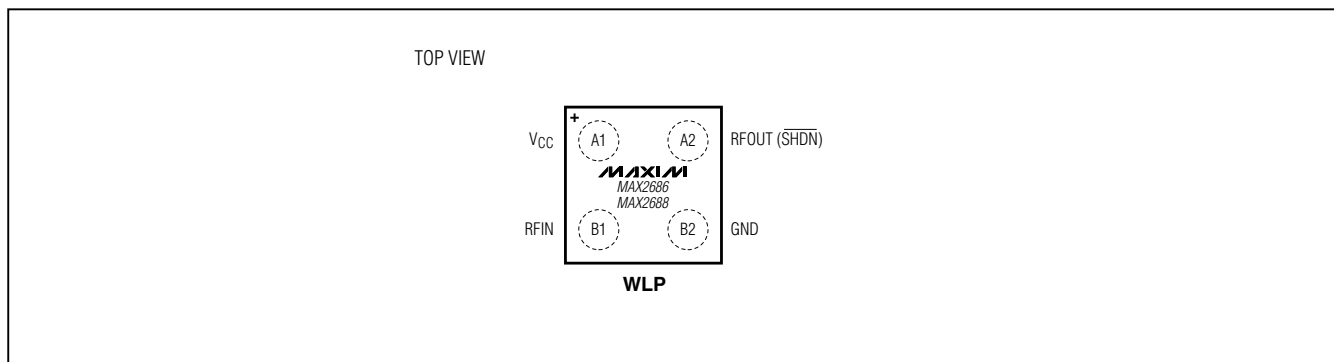

Bump Description

BUMP	NAME	FUNCTION
A1	VCC	Supply Voltage. Bypass to ground with a 10pF capacitor as close as possible to the IC.
A2	RFOUT (SHDN)	RF Output/ $\overline{\text{SHDN}}$ Input. RFOUT is internally matched to 50 Ω and pulled up to VCC through a 1M Ω resistor. $\overline{\text{SHDN}}$ is shared with the RFOUT bump. The devices are in active mode by default once VCC is applied. RFOUT($\overline{\text{SHDN}}$) can be pulled to a DC low externally to shut down the IC.
B1	RFIN	RF Input. Requires a DC-blocking capacitor and external matching components.
B2	GND	Ground. Connect to the PCB ground plane.

Detailed Description

The MAX2686/MAX2688 are LNAs designed for GPS L1, Galileo, and GLONASS applications. The devices feature an optional power-shutdown control mode to eliminate the need for an external supply switch. The devices achieve high gain, ultra-low-noise figure, and excellent linearity.

Input and Output Matching

The devices require an off-chip input matching. Only an inductor in series with a DC-blocking capacitor is needed to form the input matching circuit. The *Typical Application Circuit* shows the recommended input-matching network. These values are optimized for the best simultaneous gain, noise figure, and return loss performance. The value of the input coupling capacitor

affects IIP3. A smaller coupling capacitor results in lower IIP3. The devices integrate an on-chip output matching to 50 Ω at the output, eliminating the need for external matching components. Tables 1 and 2 list typical device S parameters and K_f values. Typical noise parameters are shown in Tables 3 and 4.

Shutdown

The devices include an optional shutdown feature to turn off the entire chip. The devices are placed in active mode by default once VCC is applied, due to the on-chip pullup resistor to VCC at the RFOUT bump (shared with the $\overline{\text{SHDN}}$ input). To shut down the part, apply a logic-low to the RFOUT bump through an external resistor with an adequate value, e.g., 25k Ω , in order not to load the RF output signal during active operation.

GPS/GNSS Low-Noise Amplifiers

Table 1. MAX2686 Typical S Parameter Values and K-Factor

FREQ. (MHz)	S11 MAG (dB)	S11 PHASE (DEGREES)	S21 MAG (dB)	S21 PHASE (DEGREES)	S12 MAG (dB)	S12 PHASE (DEGREES)	S22 MAG (dB)	S22 PHASE (DEGREES)	Kf
1000	-2.9	-26.8	6.2	-109.0	-53.0	169.0	-1.4	-57.0	15.2
1100	-3.1	-27.2	7.9	-110.0	-53.0	163.0	-2.0	-64.0	17.4
1200	-3.4	-27.0	9.5	-113.0	-52.0	157.0	-2.9	-73.0	18.0
1300	-3.5	-28.0	12.8	-128.0	-58.0	-176.0	-7.0	-99.0	40.6
1400	-3.5	-28.3	12.8	-128.0	-56.0	-164.0	-7.0	-99.0	32.3
1500	-3.9	-29.0	13.9	-144.0	-49.0	-166.0	-14.1	-124.0	16.3
1575	-4.1	-27.0	14.1	-156.0	-47.0	164.0	-29.0	-113.0	13.5
1600	-4.1	-27.7	14.1	-160.0	-48.0	154.0	-21.2	68.0	15.0
1700	-4.0	-28.1	13.9	-174.0	-54.0	166.0	-9.0	42.0	26.4
1800	-4.2	-28.9	12.9	170.0	-49.0	-160.0	-5.3	26.4	13.6
1900	-4.4	-29.0	11.4	160.0	-47.3	-176.0	-3.3	13.9	10.2
2000	-4.5	-28.9	9.9	153.0	-46.5	170.0	-2.3	5.0	8.5

Table 2. MAX2688 Typical S Parameter Values and K-Factor

FREQ. (MHz)	S11 MAG (dB)	S11 PHASE (DEGREES)	S21 MAG (dB)	S21 PHASE (DEGREES)	S12 MAG (dB)	S12 PHASE (DEGREES)	S22 MAG (dB)	S22 PHASE (DEGREES)	Kf
1000	-3.2	-18.0	3.6	-116.0	-54.0	150.0	-1.3	-53.0	22.5
1100	-3.4	-17.5	5.2	-116.9	-55.0	147.0	-1.9	-60.6	29.9
1200	-3.6	-16.8	6.8	-119.0	-56.6	147.0	-2.7	-69.2	40.5
1300	-3.5	-17.2	8.6	-124.0	-63.0	-144.0	-4.2	-80.0	90.4
1400	-3.8	-18.0	10.1	-137.5	-49.8	-145.0	-7.7	-95.0	23.7
1500	-4.0	-16.5	10.7	-151.0	-47.3	174.0	-14.5	-107.7	19.7
1575	-4.1	-15.8	11.0	-161.5	-48.3	169.0	-35.0	151.0	22.4
1600	-4.1	-15.7	11.1	-164.9	-48.7	159.0	-23.4	74.9	23.1
1700	-4.1	-16.6	11.0	-179.0	-55.0	175.0	-9.7	50.0	43.1
1800	-4.2	-16.7	10.2	165.0	-48.0	-151.0	-5.2	34.0	16.5
1900	-4.4	-16.6	8.6	155.0	-46.0	-164.0	-3.2	21.0	11.9
2000	-4.5	-16.3	7.2	149.0	-45.6	-179.0	-2.3	12.0	10.6

Table 3. MAX2686 Typical Noise Parameters (VCC = 2.85V, TA = +25°C)

FREQUENCY (MHz)	FMIN (dB)	Γ_{OPT}	Γ_{OPT} ANGLE	RN (Ω)
1550	0.63	0.43	45.7	8.25
1560	0.63	0.43	46.0	8.23
1570	0.63	0.42	46.3	8.22
1575	0.63	0.42	46.4	8.22
1580	0.63	0.42	46.5	8.21
1590	0.63	0.42	46.8	8.20
1600	0.64	0.42	47.1	8.19

GPS/GNSS Low-Noise Amplifiers

MAX2686/MAX2688

Table 4. MAX2688 Typical Noise Parameters (VCC = 2.85V, TA = +25°C)

FREQUENCY (MHz)	FMIN (dB)	$ \Gamma_{OPT} $	$ \Gamma_{OPT} $ ANGLE	RN (Ω)
1550	0.73	0.42	59.0	8.34
1560	0.74	0.42	59.4	8.31
1570	0.74	0.42	59.7	8.29
1575	0.74	0.42	59.9	8.28
1580	0.74	0.42	60.1	8.27
1590	0.74	0.41	60.5	8.25
1600	0.74	0.41	60.8	8.22

Applications Information

A properly designed PCB is essential to any RF micro-wave circuit. Use controlled-impedance lines on all high-frequency inputs and outputs. Bypass VCC with decoupling capacitors located close to the device. For long VCC lines, it may be necessary to add decoupling capacitors. Locate these additional capacitors further away from the device package. Proper grounding of the GND pin is essential. If the PCB uses a topside RF ground, connect it directly to the GND pin. For a board where the ground is not on the component layer, connect the GND pin to the board with multiple vias close to the package.

Refer to www.maxim-ic.com for the MAX2686 EV kit schematic, Gerber data, PADS layout file, and BOM information.

Chip Information

PROCESS: SiGe BiCMOS

Package Information

For the latest package outline information and land patterns, go to www.maxim-ic.com/packages. Note that a "+", "#", or "-" in the package code indicates RoHS status only. Package drawings may show a different suffix character, but the drawing pertains to the package regardless of RoHS status.

PACKAGE TYPE	PACKAGE CODE	OUTLINE NO.	LAND PATTERN NO.
4 WLP	W40A0+1	21-0480	—

GPS/GNSS Low-Noise Amplifiers

Revision History

REVISION NUMBER	REVISION DATE	DESCRIPTION	PAGES CHANGED
0	8/10	Initial release	—

Maxim cannot assume responsibility for use of any circuitry other than circuitry entirely embodied in a Maxim product. No circuit patent licenses are implied. Maxim reserves the right to change the circuitry and specifications without notice at any time.

8 _____ **Maxim Integrated Products, 120 San Gabriel Drive, Sunnyvale, CA 94086 408-737-7600**