



RF Power Field Effect Transistors

N-Channel Enhancement-Mode Lateral MOSFETs

RF Power transistors designed for applications operating at frequencies between 960 and 1215 MHz. These devices are suitable for use in pulse applications.

- Typical Pulse Performance: $V_{DD} = 50$ Volts, $I_{DQ} = 200$ mA, Pulse Width = 128 μ sec, Duty Cycle = 10%

Application	P_{out} (W)	f (MHz)	G_{ps} (dB)	η_D (%)
Narrowband	500 Peak	1030	19.7	62.0
Broadband	500 Peak	960-1215	18.5	57.0

- Capable of Handling 10:1 VSWR, @ 50 Vdc, 1030 MHz, 500 Watts Peak Power

Features

- Characterized with Series Equivalent Large-Signal Impedance Parameters
- Internally Matched for Ease of Use
- Qualified Up to a Maximum of 50 V_{DD} Operation
- Integrated ESD Protection
- Greater Negative Gate-Source Voltage Range for Improved Class C Operation
- In Tape and Reel. R3 Suffix = 250 Units per 56 mm, 13 inch Reel. For R5 Tape and Reel option, see p. 14.

MRF6V12500HR3
MRF6V12500HSR3

960-1215 MHz, 500 W, 50 V PULSE
LATERAL N-CHANNEL
RF POWER MOSFETs

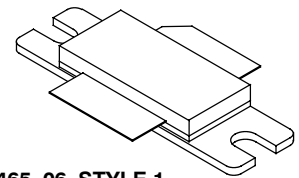

CASE 465-06, STYLE 1
NI-780
MRF6V12500HR3

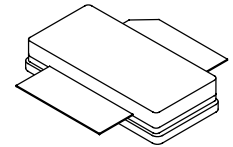

CASE 465A-06, STYLE 1
NI-780S
MRF6V12500HSR3

Table 1. Maximum Ratings

Rating	Symbol	Value	Unit
Drain-Source Voltage	V_{DSS}	-0.5, +110	Vdc
Gate-Source Voltage	V_{GS}	-6.0, +10	Vdc
Storage Temperature Range	T_{stg}	-65 to +150	$^{\circ}$ C
Case Operating Temperature	T_C	150	$^{\circ}$ C
Operating Junction Temperature (1,2)	T_J	225	$^{\circ}$ C

Table 2. Thermal Characteristics

Characteristic	Symbol	Value (2,3)	Unit
Thermal Impedance, Junction to Case Case Temperature 80 $^{\circ}$ C, 500 W Pulse, 128 μ sec Pulse Width, 10% Duty Cycle	$Z_{\theta JC}$	0.044	$^{\circ}$ C/W

1. Continuous use at maximum temperature will affect MTTF.
2. MTTF calculator available at <http://www.freescale.com/rf>. Select Software & Tools/Development Tools/Calculators to access MTTF calculators by product.
3. Refer to AN1955, *Thermal Measurement Methodology of RF Power Amplifiers*. Go to <http://www.freescale.com/rf>. Select Documentation/Application Notes - AN1955.

Table 3. ESD Protection Characteristics

Test Methodology	Class
Human Body Model (per JESD22-A114)	2, passes 2600 V
Machine Model (per EIA/JESD22-A115)	B, passes 200 V
Charge Device Model (per JESD22-C101)	IV, passes 2000 V

Table 4. Electrical Characteristics ($T_A = 25^\circ\text{C}$ unless otherwise noted)

Characteristic	Symbol	Min	Typ	Max	Unit
----------------	--------	-----	-----	-----	------

Off Characteristics

Gate-Source Leakage Current ($V_{GS} = 5\text{ Vdc}$, $V_{DS} = 0\text{ Vdc}$)	I_{GSS}	—	—	10	μAdc
Drain-Source Breakdown Voltage ($V_{GS} = 0\text{ Vdc}$, $I_D = 200\text{ mA}$)	$V_{(BR)DSS}$	110	—	—	Vdc
Zero Gate Voltage Drain Leakage Current ($V_{DS} = 50\text{ Vdc}$, $V_{GS} = 0\text{ Vdc}$)	I_{DSS}	—	—	20	μAdc
Zero Gate Voltage Drain Leakage Current ($V_{DS} = 90\text{ Vdc}$, $V_{GS} = 0\text{ Vdc}$)	I_{DSS}	—	—	200	μAdc

On Characteristics

Gate Threshold Voltage ($V_{DS} = 10\text{ Vdc}$, $I_D = 1.32\text{ mA}$)	$V_{GS(th)}$	0.9	1.7	2.4	Vdc
Gate Quiescent Voltage ($V_{DD} = 50\text{ Vdc}$, $I_D = 200\text{ mAdc}$, Measured in Functional Test)	$V_{GS(Q)}$	1.7	2.4	3.2	Vdc
Drain-Source On-Voltage ($V_{GS} = 10\text{ Vdc}$, $I_D = 3.26\text{ Adc}$)	$V_{DS(on)}$	—	0.25	—	Vdc

Dynamic Characteristics (1)

Reverse Transfer Capacitance ($V_{DS} = 50\text{ Vdc} \pm 30\text{ mV(rms)ac}$ @ 1 MHz, $V_{GS} = 0\text{ Vdc}$)	C_{rss}	—	0.2	—	pF
Output Capacitance ($V_{DS} = 50\text{ Vdc} \pm 30\text{ mV(rms)ac}$ @ 1 MHz, $V_{GS} = 0\text{ Vdc}$)	C_{oss}	—	697	—	pF
Input Capacitance ($V_{DS} = 50\text{ Vdc}$, $V_{GS} = 0\text{ Vdc} \pm 30\text{ mV(rms)ac}$ @ 1 MHz)	C_{iss}	—	1391	—	pF

Functional Tests (In Freescale Narrowband Test Fixture, 50 ohm system) $V_{DD} = 50\text{ Vdc}$, $I_{DQ} = 200\text{ mA}$, $P_{out} = 500\text{ W Peak}$ (50 W Avg.), $f = 1030\text{ MHz}$, 128 μsec Pulse Width, 10% Duty Cycle

Power Gain	G_{ps}	18.5	19.7	22.0	dB
Drain Efficiency	η_D	58.0	62.0	—	%
Input Return Loss	IRL	—	-18	-9	dB

Typical Broadband Performance — 960-1215 MHz (In Freescale 960-1215 MHz Test Fixture, 50 ohm system) $V_{DD} = 50\text{ Vdc}$, $I_{DQ} = 200\text{ mA}$, $P_{out} = 500\text{ W Peak}$ (50 W Avg.), $f = 960\text{--}1215\text{ MHz}$, 128 μsec Pulse Width, 10% Duty Cycle

Power Gain	G_{ps}	—	18.5	—	dB
Drain Efficiency	η_D	—	57.0	—	%

1. Part internally matched both on input and output.

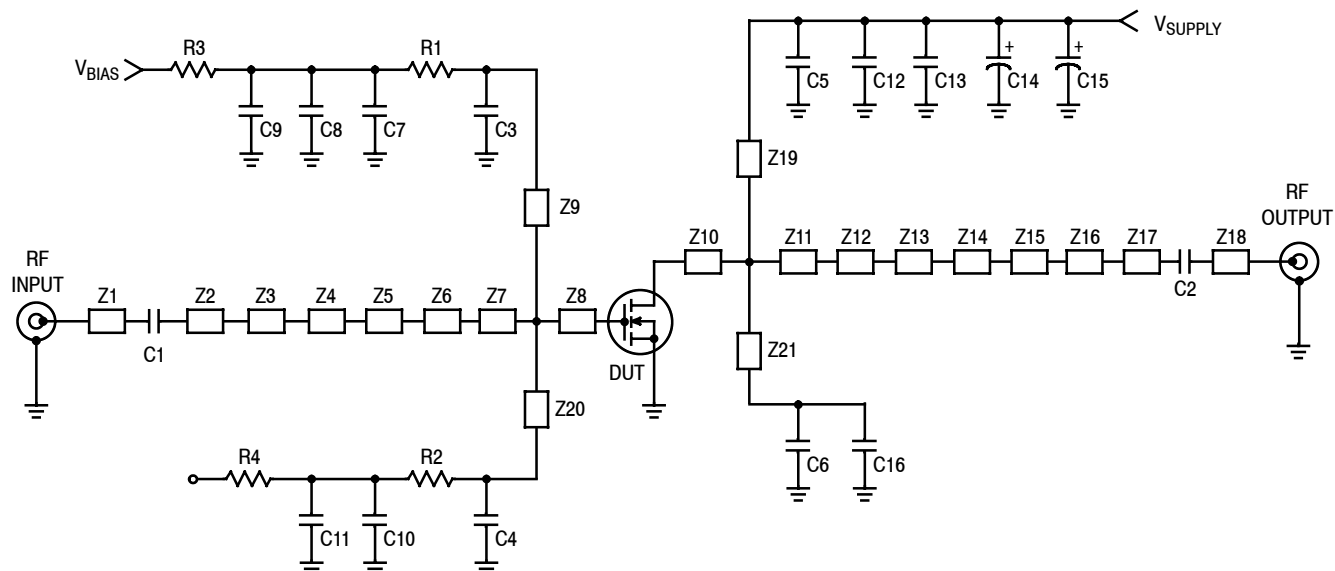

Z1	0.457" x 0.080" Microstrip	Z11	0.161" x 1.500" Microstrip
Z2	0.250" x 0.080" Microstrip	Z12	0.613" x 1.281" Microstrip
Z3	0.605" x 0.040" Microstrip	Z13	0.248" x 0.865" Microstrip
Z4	0.080" x 0.449" Microstrip	Z14	0.087" x 0.425" Microstrip
Z5	0.374" x 0.608" Microstrip	Z15	0.309" x 0.090" Microstrip
Z6	0.118" x 1.252" Microstrip	Z16	0.193" x 0.516" Microstrip
Z7	0.778" x 1.710" Microstrip	Z17	0.279" x 0.080" Microstrip
Z8	0.095" x 1.710" Microstrip	Z18	0.731" x 0.080" Microstrip
Z9, Z20	0.482" x 0.050" Microstrip	Z19, Z21	0.507" x 0.040" Microstrip
Z10	0.138" x 1.500" Microstrip	PCB	Arlon CuClad 250GX-0300-55-22, 0.030", $\epsilon_r = 2.55$

Figure 1. MRF6V12500HR3(HSR3) Test Circuit Schematic

Table 5. MRF6V12500HR3(HSR3) Test Circuit Component Designations and Values

Part	Description	Part Number	Manufacturer
C1, C2	5.1 pF Chip Capacitors	ATC100B5R1CT500XT	ATC
C3, C4, C5, C6	33 pF Chip Capacitors	ATC100B330JT500XT	ATC
C7, C10	10 μ F, 50 V Chip Capacitors	GRM55DR61H106KA88L	Murata
C8, C11, C13, C16	2.2 μ F, 100 V Chip Capacitors	2225X7R225KT3AB	ATC
C9	22 μ F, 25 V Chip Capacitor	TPSD226M025R0200	AVX
C12	1 μ F, 100 V Chip Capacitor	GRM31CR72A105KA01L	Murata
C14, C15	470 μ F, 63 V Electrolytic Capacitors	MCGPR63V477M13X26-RH	Multicomp
R1, R2	56 Ω , 1/4 W Chip Resistors	CRCW120656R0FKEA	Vishay
R3, R4	0 Ω , 3 A Chip Resistors	CRCW12060000Z0EA	Vishay

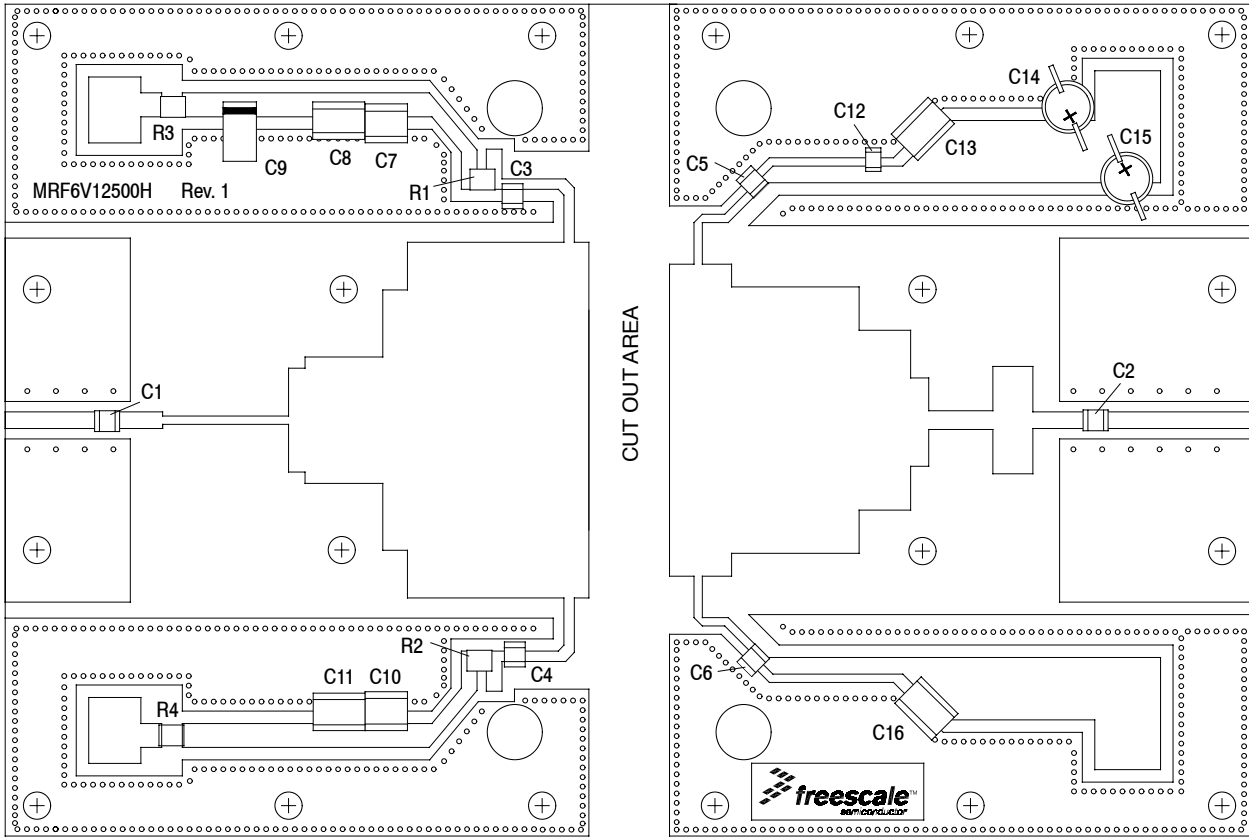

Figure 2. MRF6V12500HR3(HSR3) Test Circuit Component Layout

TYPICAL CHARACTERISTICS

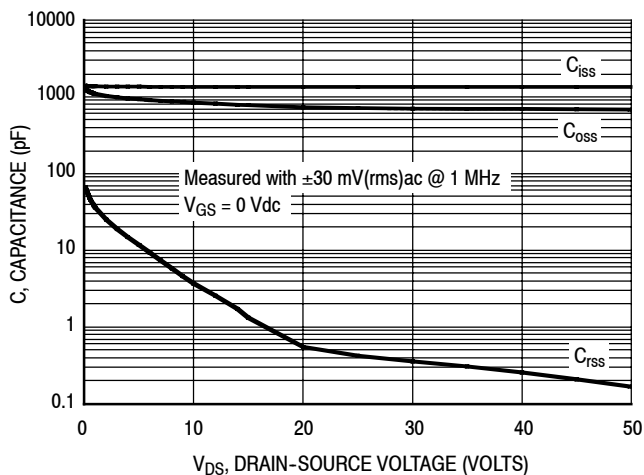

Figure 3. Capacitance versus Drain-Source Voltage

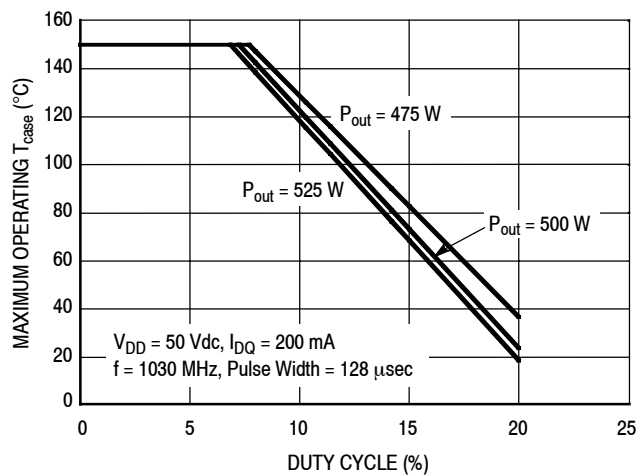

Figure 4. Safe Operating Area

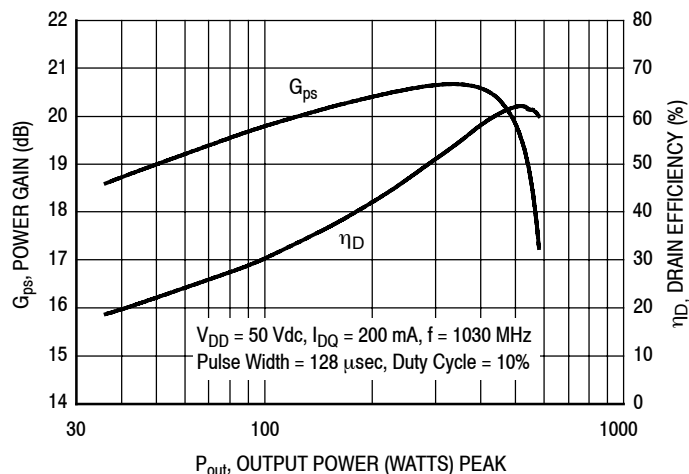

Figure 5. Power Gain and Drain Efficiency versus Output Power

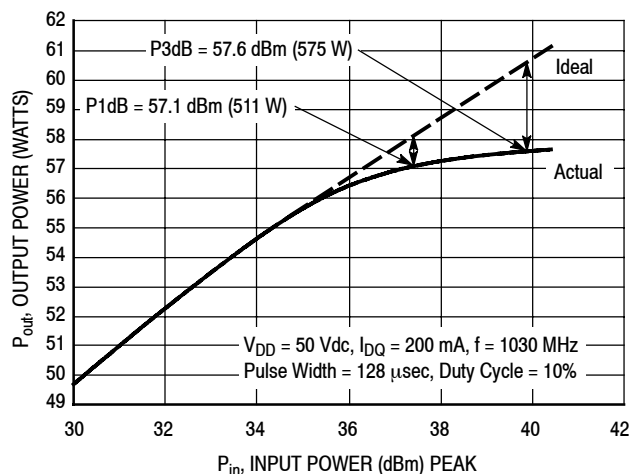

Figure 6. Output Power versus Input Power

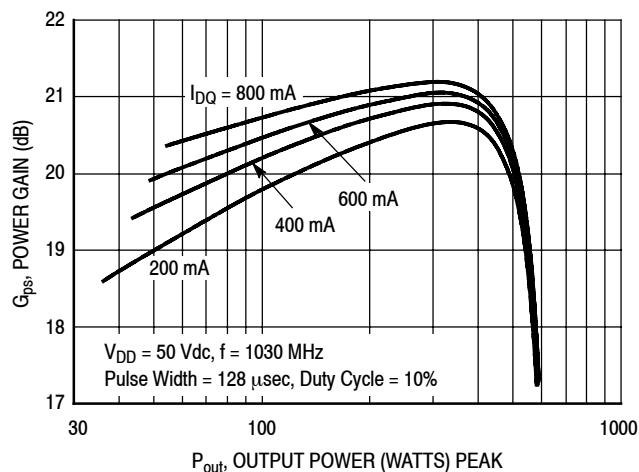

Figure 7. Power Gain versus Output Power

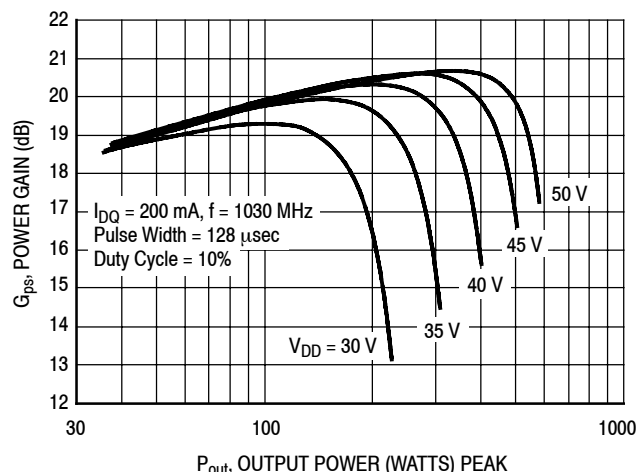

Figure 8. Power Gain versus Output Power

TYPICAL CHARACTERISTICS

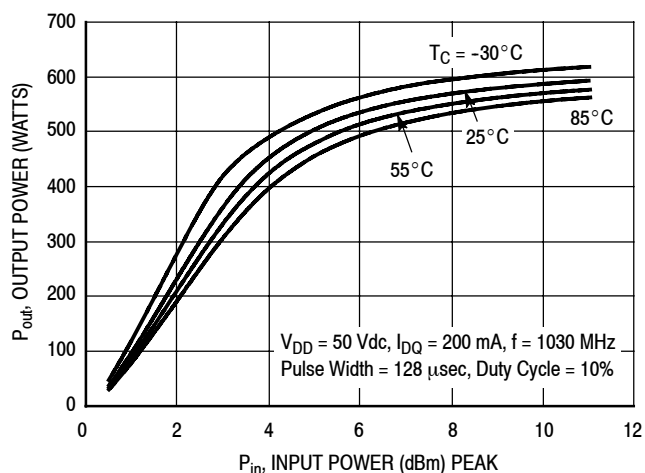

Figure 9. Output Power versus Input Power

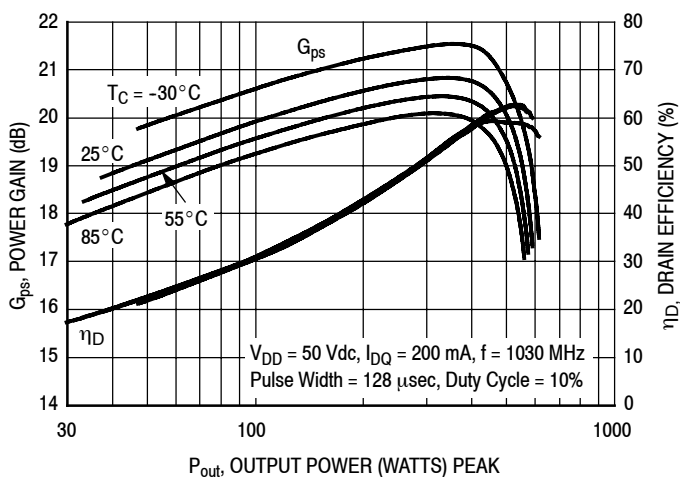
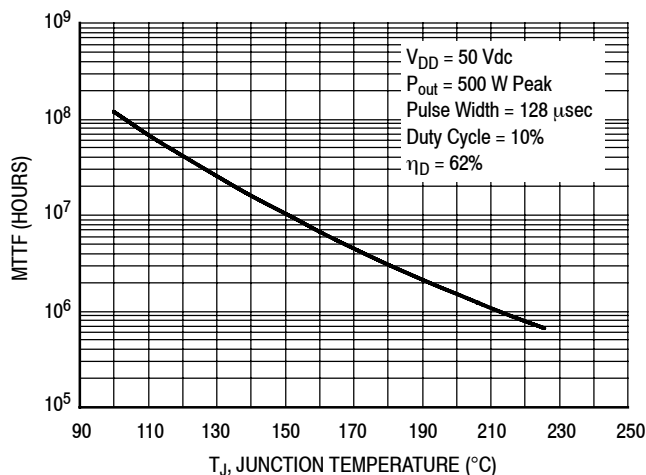

Figure 10. Power Gain and Drain Efficiency versus Output Power



MTTF calculator available at <http://www.freescale.com/rf>. Select Software & Tools/Development Tools/Calculators to access MTTF calculators by product.

Figure 11. MTTF versus Junction Temperature

$V_{DD} = 50 \text{ Vdc}$, $I_{DQ} = 200 \text{ mA}$, $P_{out} = 500 \text{ W Peak}$

f MHz	Z_{source} Ω	Z_{load} Ω
1030	$1.36 - j1.27$	$2.50 - j0.17$

Z_{source} = Test circuit impedance as measured from gate to ground.

Z_{load} = Test circuit impedance as measured from drain to ground.

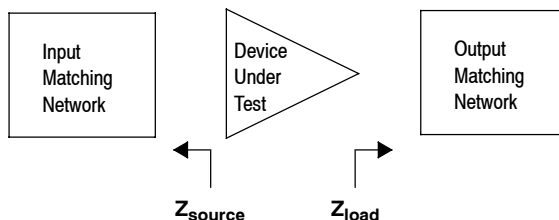

Figure 12. Series Equivalent Source and Load Impedance

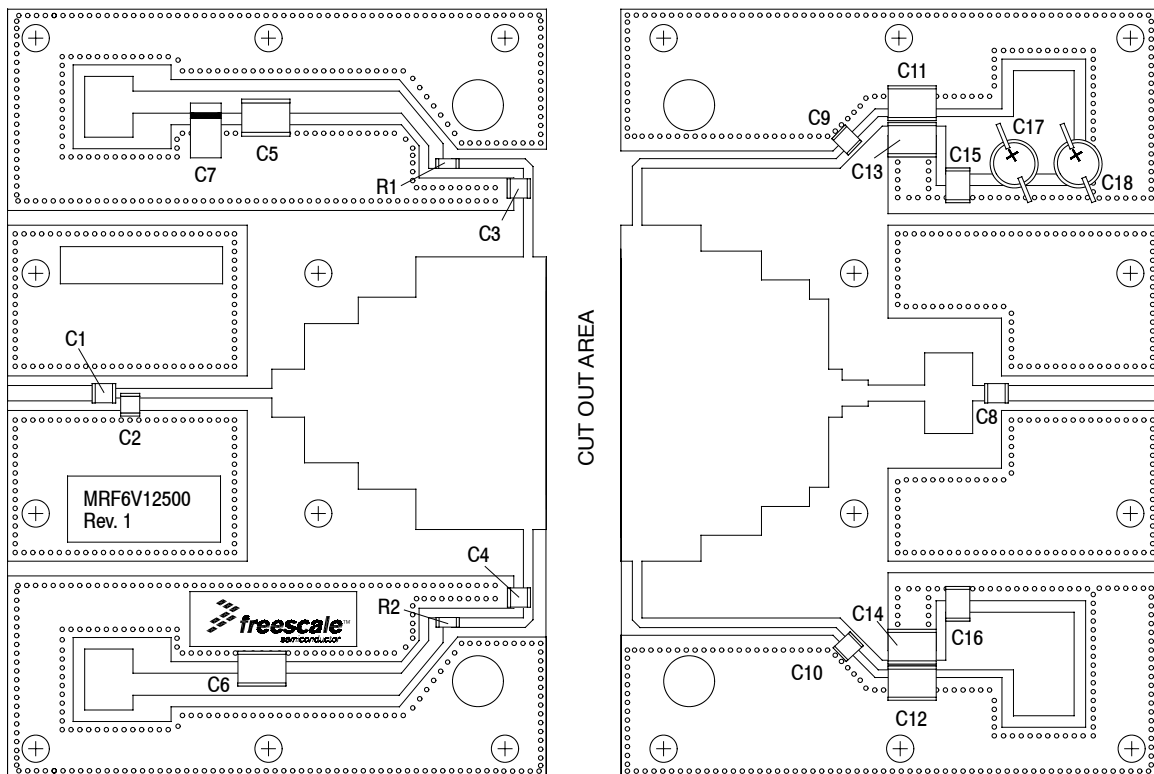

Figure 13. MRF6V12500H(HS) Test Circuit Component Layout — 960-1215 MHz

Table 6. MRF6V12500H(HS) Test Circuit Component Designations and Values — 960-1215 MHz

Part	Description	Part Number	Manufacturer
C1	2.2 pF Chip Capacitor	ATC100B2R2JT500XT	ATC
C2	0.2 pF Chip Capacitor	ATC100B0R2BT500XT	ATC
C3, C4	33 pF Chip Capacitors	ATC100B330JT500XT	ATC
C5, C6, C11, C12	2.2 μ F, 100 V Chip Capacitors	G2225X7R225KT3AB	ATC
C7	22 μ F, 35 V Tantalum Capacitor	T491X226K035AT	Kemet
C8	8.2 pF Chip Capacitor	ATC100B8R2CT500XT	ATC
C9, C10	39 pF Chip Capacitors	ATC100B390JT500XT	ATC
C13, C14	0.022 μ F, 100 V Chip Capacitors	C1825C223K1GAC	Kemet
C15, C16	0.10 μ F, 100 V Chip Capacitors	C1812F104K1RAC	Kemet
C17, C18	470 μ F, 63 V Electrolytic Capacitors	MCGPR63V477M13X26-RH	Multicomp
R1, R2	22 Ω , 1/4 W Chip Resistors	CRCW120622R0FKEA	Vishay
PCB	0.030", $\epsilon_r = 2.55$	AD255A	Arlon

TYPICAL CHARACTERISTICS — 960-1215 MHz

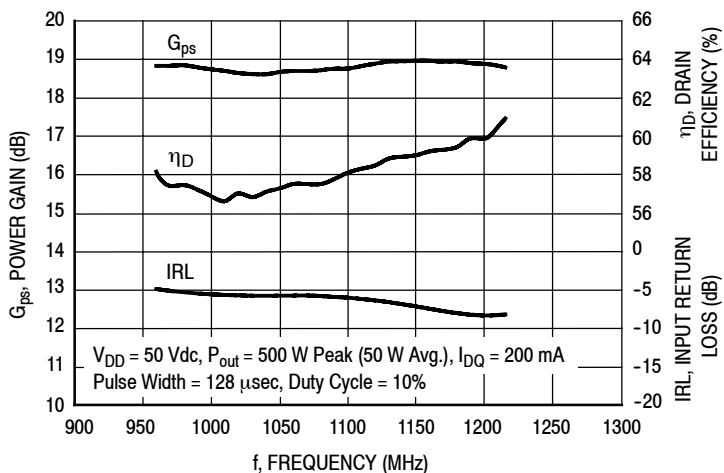

Figure 14. Power Gain, Drain Efficiency and IRL versus Frequency

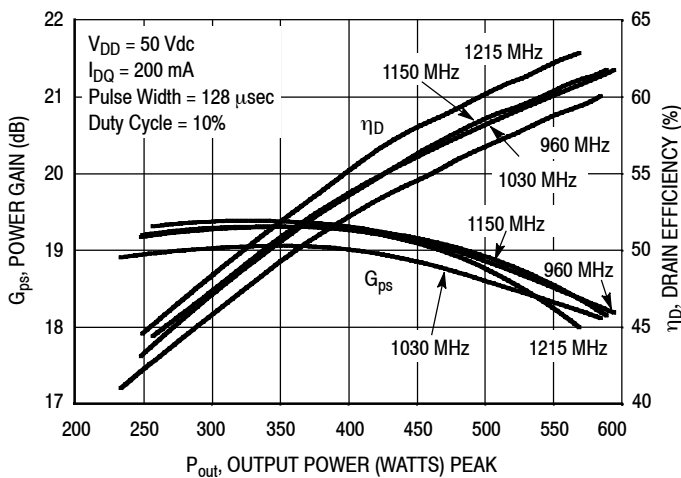
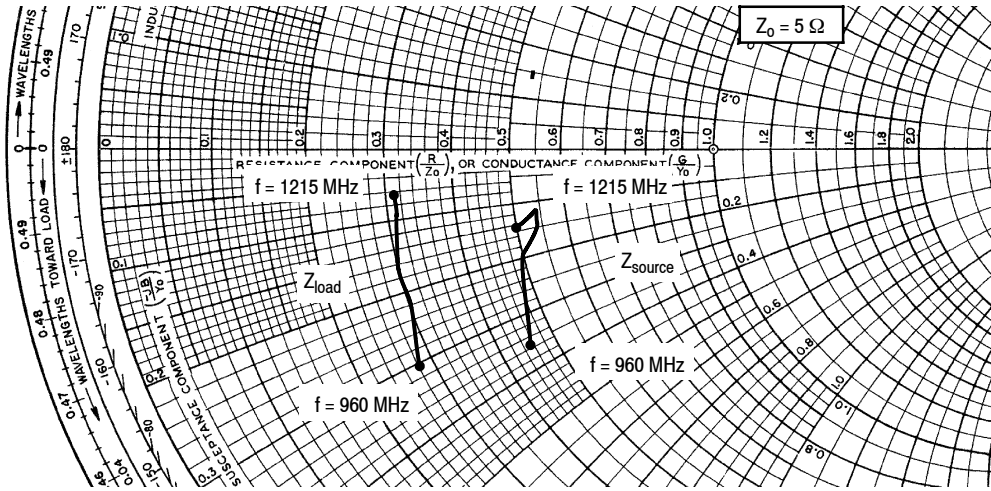

Figure 15. Power Gain and Drain Efficiency versus Output Power



$V_{DD} = 50 \text{ Vdc}$, $I_{DQ} = 200 \text{ mA}$, $P_{out} = 500 \text{ W Peak}$

f MHz	Z_{source} Ω	Z_{load} Ω
960	$2.25 - j1.78$	$1.38 - j1.53$
1030	$2.51 - j1.02$	$1.48 - j1.11$
1090	$2.69 - j0.73$	$1.51 - j0.78$
1150	$2.71 - j0.65$	$1.53 - j0.49$
1215	$2.48 - j0.76$	$1.53 - j0.33$

Z_{source} = Test circuit impedance as measured from gate to ground.

Z_{load} = Test circuit impedance as measured from drain to ground.

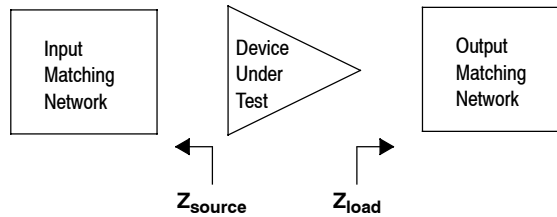
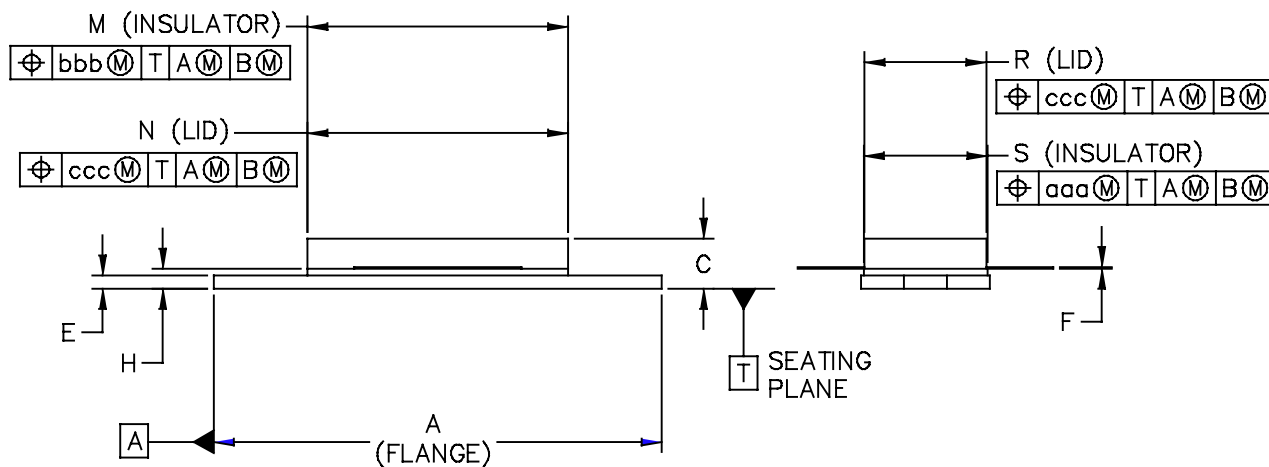
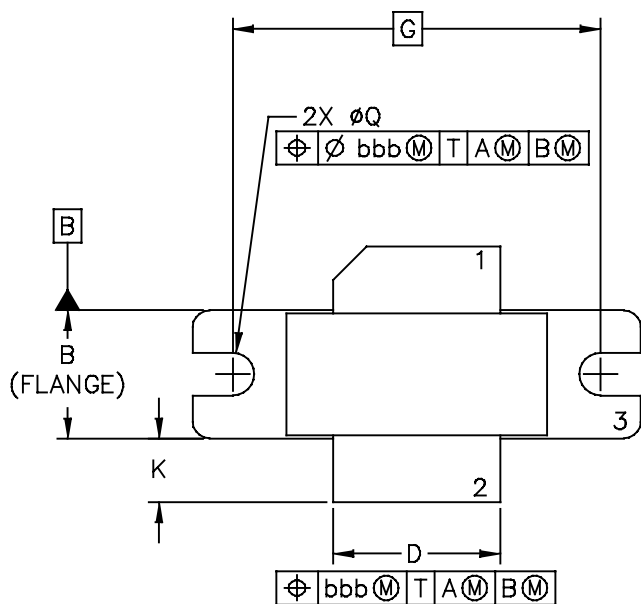

Figure 16. Series Equivalent Source and Load Impedance — 960-1215 MHz

PACKAGE DIMENSIONS



© FREESCALE SEMICONDUCTOR, INC. ALL RIGHTS RESERVED.	MECHANICAL OUTLINE	PRINT VERSION NOT TO SCALE	
TITLE: NI-780	DOCUMENT NO: 98ASB15607C	REV: G	
	CASE NUMBER: 465-06	31 MAR 2005	
	STANDARD: NON-JEDEC		

NOTES:

1. DIMENSIONING AND TOLERANCING PER ANSI Y14.5M-1994.
2. CONTROLLING DIMENSION: INCH.
3. DELETED
4. DIMENSION H IS MEASURED .030 (.762) AWAY FROM PACKAGE BODY.

STYLE 1:

- PIN 1. DRAIN
 2. GATE
 3. SOURCE

DIM	INCH		MILLIMETER		DIM	INCH		MILLIMETER	
	MIN	MAX	MIN	MAX		MIN	MAX	MIN	MAX
A	1.335	1.345	33.91	34.16	R	.365	.375	9.27	9.53
B	.380	.390	9.65	9.91	S	.365	.375	9.27	9.52
C	.125	.170	3.18	4.32	aaa	—	.005	—	0.127
D	.495	.505	12.57	12.83	bbb	—	.010	—	0.254
E	.035	.045	0.89	1.14	ccc	—	.015	—	0.381
F	.003	.006	0.08	0.15	—	—	—	—	—
G	1.100 BSC		27.94 BSC		—	—	—	—	—
H	.057	.067	1.45	1.7	—	—	—	—	—
K	.170	.210	4.32	5.33	—	—	—	—	—
M	.774	.786	19.66	19.96	—	—	—	—	—
N	.772	.788	19.6	20	—	—	—	—	—
Q	∅.118	∅.138	∅3	∅3.51	—	—	—	—	—

© FREESCALE SEMICONDUCTOR, INC. ALL RIGHTS RESERVED.	MECHANICAL OUTLINE	PRINT VERSION NOT TO SCALE
TITLE: NI-780	DOCUMENT NO: 98ASB15607C CASE NUMBER: 465-06 STANDARD: NON-JEDEC	REV: G 31 MAR 2005

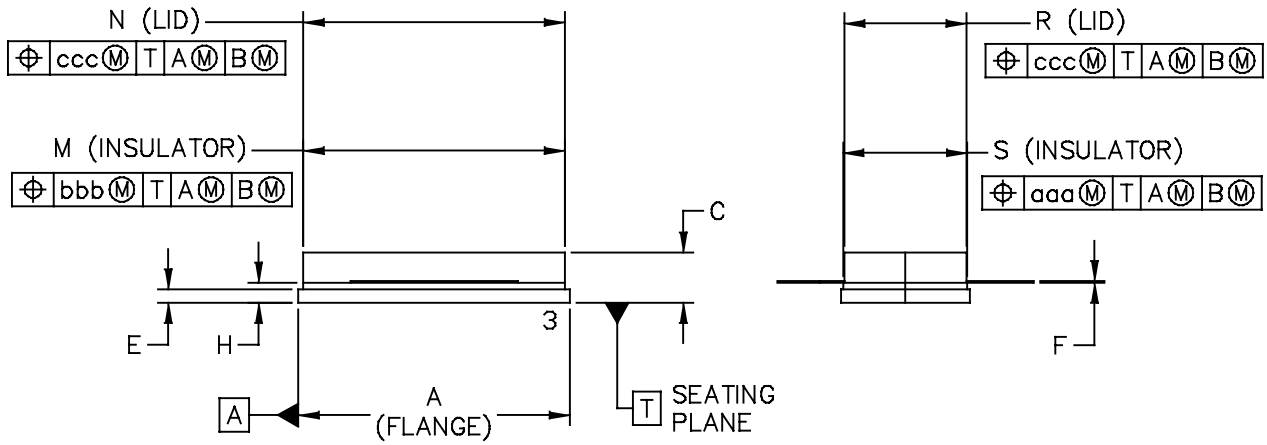
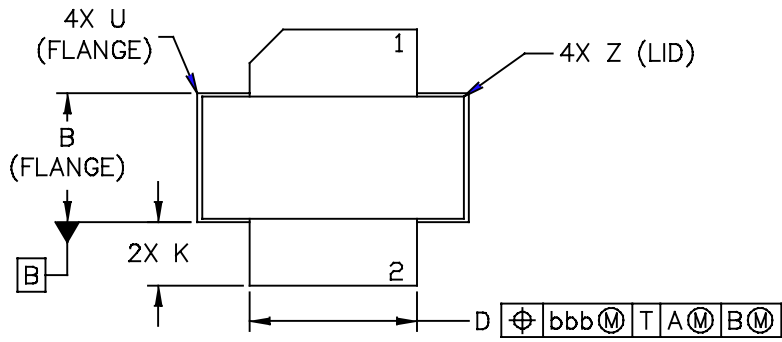

© FREESCALE SEMICONDUCTOR, INC. ALL RIGHTS RESERVED.	MECHANICAL OUTLINE	PRINT VERSION NOT TO SCALE	
TITLE: NI-780S	DOCUMENT NO: 98ASB16718C	REV: H	
	CASE NUMBER: 465A-06	31 MAR 2005	
	STANDARD: NON-JEDEC		

NOTES:

1. DIMENSIONING AND TOLERANCING PER ANSI Y14.5M-1994.
2. CONTROLLING DIMENSION: INCH.
3. DELETED
4. DIMENSION H IS MEASURED .030 (0.762) AWAY FROM PACKAGE BODY.

STYLE 1:

- PIN 1. DRAIN
2. GATE
3. SOURCE

DIM	INCH		MILLIMETER		DIM	INCH		MILLIMETER	
	MIN	MAX	MIN	MAX		MIN	MAX	MIN	MAX
A	.805	-.815	20.45	20.7	U	-	-.040	-	1.02
B	.380	-.390	9.65	9.91	Z	-	-.030	-	0.76
C	.125	-.170	3.18	4.32	aaa	-	.005	-	0.127
D	.495	-.505	12.57	12.83	bbb	-	.010	-	0.254
E	.035	-.045	0.89	1.14	ccc	-	.015	-	0.381
F	.003	-.006	0.08	0.15	-	-	-	-	-
H	.057	-.067	1.45	1.7	-	-	-	-	-
K	.170	-.210	4.32	5.33	-	-	-	-	-
M	.774	-.786	19.61	20.02	-	-	-	-	-
N	.772	-.788	19.61	20.02	-	-	-	-	-
R	.365	-.375	9.27	9.53	-	-	-	-	-
S	.365	-.375	9.27	9.52	-	-	-	-	-

© FREESCALE SEMICONDUCTOR, INC. ALL RIGHTS RESERVED.	MECHANICAL OUTLINE	PRINT VERSION NOT TO SCALE
TITLE: NI-780S	DOCUMENT NO: 98ASB16718C	REV: H
	CASE NUMBER: 465A-06	31 MAR 2005
	STANDARD: NON-JEDEC	

PRODUCT DOCUMENTATION AND SOFTWARE

Refer to the following documents and software to aid your design process.

Application Notes

- AN1955: Thermal Measurement Methodology of RF Power Amplifiers

Engineering Bulletins

- EB212: Using Data Sheet Impedances for RF LDMOS Devices

Software

- Electromigration MTTF Calculator
- RF High Power Model

For Software, do a Part Number search at <http://www.freescale.com>, and select the “Part Number” link. Go to the Software & Tools tab on the part’s Product Summary page to download the respective tool.

R5 TAPE AND REEL OPTION

R5 Suffix = 50 Units, 56 mm Tape Width, 13 inch Reel.

The R5 tape and reel option for MRF6V12500H and MRF6V12500HS parts will be available for 2 years after release of MRF6V12500H and MRF6V12500HS. Freescale Semiconductor, Inc. reserves the right to limit the quantities that will be delivered in the R5 tape and reel option. At the end of the 2 year period customers who have purchased these devices in the R5 tape and reel option will be offered MRF6V12500H and MRF6V12500HS in the R3 tape and reel option.

REVISION HISTORY

The following table summarizes revisions to this document.

Revision	Date	Description
0	Sept. 2009	<ul style="list-style-type: none">• Initial Release of Data Sheet
1	Apr. 2010	<ul style="list-style-type: none">• Operating Junction Temperature increased from 200°C to 225°C in Maximum Ratings table and related “Continuous use at maximum temperature will affect MTTF” footnote added, p. 1• Added RF High Power Model availability to Product Software, p. 9
2	Sept. 2010	<ul style="list-style-type: none">• Maximum Ratings table: corrected V_{DSS} from -0.5, +100 to -0.5, +110 Vdc, p. 2• Added 960–1215 MHz Broadband application as follows:<ul style="list-style-type: none">- Typical Performance, p. 1, 2- Fig. 13, Test Circuit Component Layout and Table 6, Test Circuit Component Designations and Values, p. 8- Fig. 14, Pulsed Power Gain, Drain Efficiency and IRL versus Frequency, p. 9- Fig. 15, Power Gain and Drain Efficiency versus Output Power, p. 9- Fig. 16, Series Equivalent Source and Load Impedance, p. 10
3	June 2012	<ul style="list-style-type: none">• Table 3, ESD Protection Characteristics: added the device’s ESD passing level as applicable to each ESD class, p. 2• Modified figure titles and/or graph axes labels to clarify application use, p. 5, 6, 9• Fig. 6, Output Power versus Input Power: corrected P_{out}, Output Power unit of measure to watts, p. 5• Fig. 9, Output Power versus Input Power: corrected P_{out}, Output Power unit of measure to watts, p. 6• Fig. 11, MTTF versus Junction Temperature: MTTF end temperature on graph changed to match maximum operating junction temperature, p. 6

How to Reach Us:

Home Page:
freescale.com

Web Support:
freescale.com/support

Information in this document is provided solely to enable system and software implementers to use Freescale products. There are no express or implied copyright licenses granted hereunder to design or fabricate any integrated circuits based on the information in this document.

Freescale reserves the right to make changes without further notice to any products herein. Freescale makes no warranty, representation, or guarantee regarding the suitability of its products for any particular purpose, nor does Freescale assume any liability arising out of the application or use of any product or circuit, and specifically disclaims any and all liability, including without limitation consequential or incidental damages. "Typical" parameters that may be provided in Freescale data sheets and/or specifications can and do vary in different applications, and actual performance may vary over time. All operating parameters, including "typicals," must be validated for each customer application by customer's technical experts. Freescale does not convey any license under its patent rights nor the rights of others. Freescale sells products pursuant to standard terms and conditions of sale, which can be found at the following address: <http://www.reg.net/v2/webservices/Freescale/Docs/TermsandConditions.htm>.

Freescale, the Freescale logo, Altivec, C-5, CodeTest, CodeWarrior, ColdFire, C-Ware, Energy Efficient Solutions logo, Kinetis, mobileGT, PowerQUICC, Processor Expert, QorIQ, Qorivva, StarCore, Symphony, and VortiQa are trademarks of Freescale Semiconductor, Inc., Reg. U.S. Pat. & Tm. Off. Airfast, BeeKit, BeeStack, ColdFire+, CoreNet, Flexis, MagniV, MXC, Platform in a Package, QorIQ Qonverge, QUICC Engine, Ready Play, SafeAssure, SMARTMOS, TurboLink, Vybrid, and Xtrinsic are trademarks of Freescale Semiconductor, Inc. All other product or service names are the property of their respective owners.

© 2009-2010, 2012 Freescale Semiconductor, Inc.

