



Ordering number CP12671_TINA2-D

Family	Tina2	FWHM	14 degrees
Type	Assembly	Efficiency	88 %
LED	XB-D	cd/lm	8.700
Color	Black	Gerber File	Available
Diameter	16.1 mm		
Height	9.65 mm		
Style	Round		
Optic Material	PMMA		
Holder Material	PC		
Fastening	Glue		
Status	Ready		



Ordering number CP12672_TINA2-M

Family	Tina2	FWHM	29 degrees
Type	Assembly	Efficiency	82 %
LED	XB-D	cd/lm	2.700
Color	Black	Gerber File	Available
Diameter	16.1 mm		
Height	9.65 mm		
Style	Round		
Optic Material	PMMA		
Holder Material	PC		
Fastening	Glue		
Status	Ready		



Ordering number CP12673_TINA2-O

Family	Tina2	FWHM	35+14 degrees
Type	Assembly	Efficiency	84 %
LED	XB-D	cd/lm	4.300
Color	Black	Gerber File	Available
Diameter	16.1 mm		
Height	9.65 mm		
Style	Round		
Optic Material	PMMA		
Holder Material	PC		
Fastening	Glue		
Status	Ready		



Ordering number CP12674_TINA2-W

Family	Tina2	FWHM	39 degrees
Type	Assembly	Efficiency	81 %
LED	XB-D	cd/lm	1.800
Color	Black	Gerber File	Available
Diameter	16.1 mm		
Height	9.65 mm		
Style	Round		
Optic Material	PMMA		
Holder Material	PC		
Fastening	Glue		
Status	Ready		



PRODUCT DATASHEET

Tina2 series

last update 19/6/2012



NOTE: The typical divergence will be changed by different color, chip size and chip position tolerance. The typical total divergence is the full angle measured where the luminous intensity is half of the peak value.



PRODUCT DATASHEET Tina2 series

last update 19/6/2012



GENERAL INFORMATION

- Product series especially designed & optimized for XB-D series of LEDs.
- Special care taken to make light distribution as uniform as possible.
- Lens material optical grade PMMA with high UV and temperature resistance (105 degrees of Celcius / 220 degrees of Fahrenheit). Allows use of high current and temperature conditions.

Please find more information about used material from below:

http://ledil.fi/sites/default/files/Documents/Technical/Material/PMMA%20N%20UL94_Yellow%20Card.pdf

<http://ledil.fi/sites/default/files/Documents/Technical/Material/PMMA%20N%20PLEXIGLAS-Datasheet.pdf>

- Optic holder molded by high quality PC material (120 dergees of Celcius / 248 degrees of Fahrenheit).

- Fastening to PCB with appropriate adhesive. By clicking link below you can find Ledil recommended glue options.

http://www.ledil.com/datasheets/DataSheet_GLUES.pdf

NOTE 1: We advise customer to ensure the suitability and sufficiency of the bond in the end product. For example, mechanical stress, vibration and holes on the surface of the circuit board weaken the strength of the glue.

NOTE 2: All surfaces where glue is applied must be clean, dry and free from grease and dirt. If cleaning of PCB surfaces is needed, please follow strictly the cleaning instructions of your LED manufacturer -this is important as cleaning shall under no circumstances damage LEDs or other electronics components on the PCB.

Further note that optical components shall not be cleaned with any chemicals - only micro fiber cloth may be used to remove fingerprints or other traces from handling.

D

C

B

A

4

4

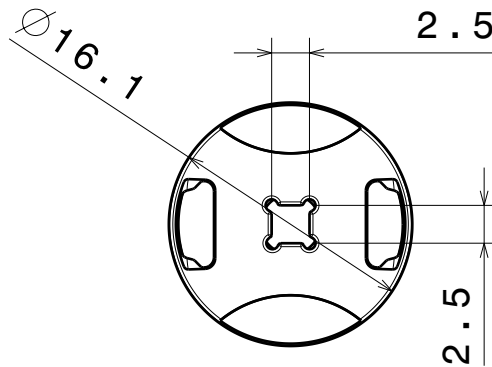
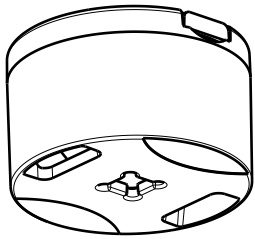
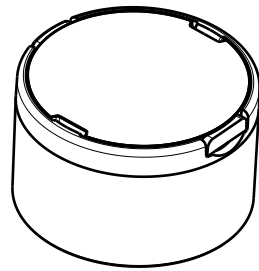

3

3

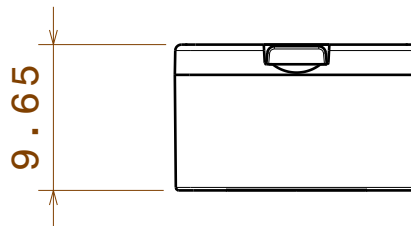

2

2

Materials:
 lens PMMA
 holder PC, black

Fastening to application:
 Glue

Tolerances for dimensions:
 0-20mm tolerance value +/-0.1mm

This drawing is our property.
 It can't be reproduced
 or communicated without
 our written agreement.



Ledil Oy
 Salorankatu 10
 FIN 24240 SALO
 Finland

DRAWING TITLE

Datasheet Tina2 XB assy

1

1

DRAWN BY

pv

DATE

19.03.2012

CHECKED BY

sn

DATE

19.03.2012

DESIGNED BY

pv

DATE

12.03.2012

SIZE

A4

DRAWING NUMBER

-

REV

1

SCALE

2:1

WEIGHT (g)

SHEET

1/1

D

A

Luminaire: LEDIL OY CP12671_TINA2-D (XB-D) Efficiency=88%
Lamps: 1 x Cree XB-D white (97lm @ 250mA)

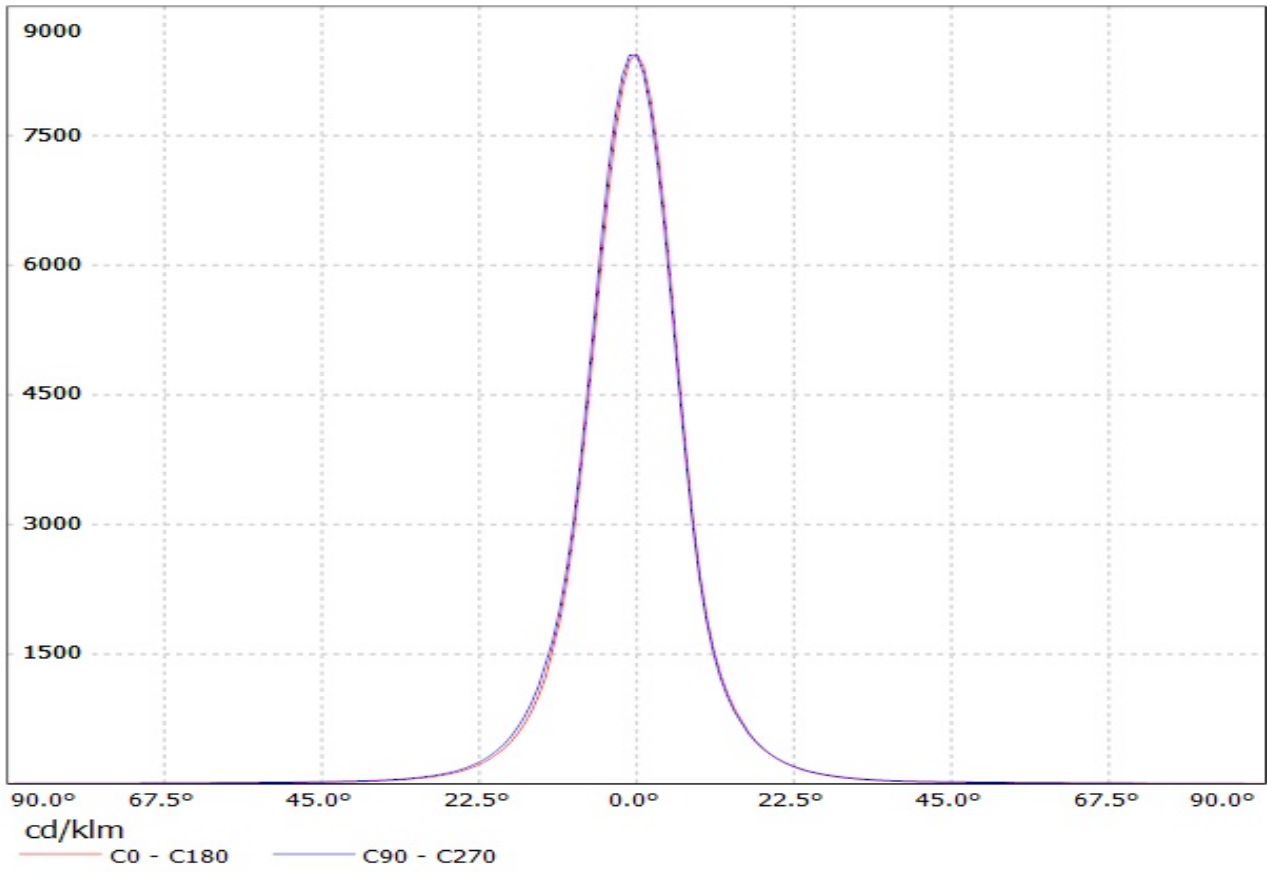

Luminaire: LEDIL OY CP12672_TINA2-M (XB-D) Efficiency=82%
Lamps: 1 x Cree XB-D white (97lm @ 250mA)

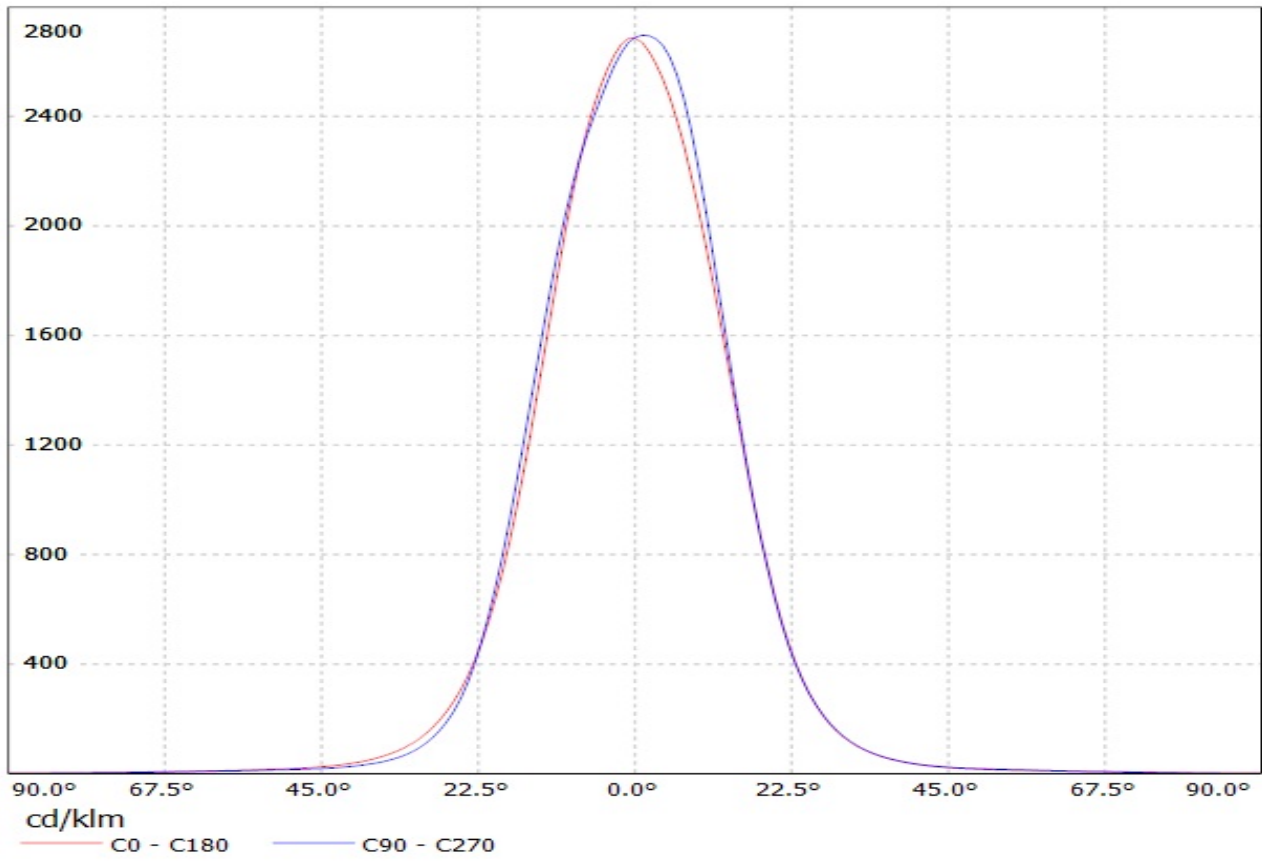

Luminaire: LEDIL OY CP12673_TINA2-O (XB-D) Efficiency=84%
Lamps: 1 x Cree XB-D white (97lm @ 250mA)

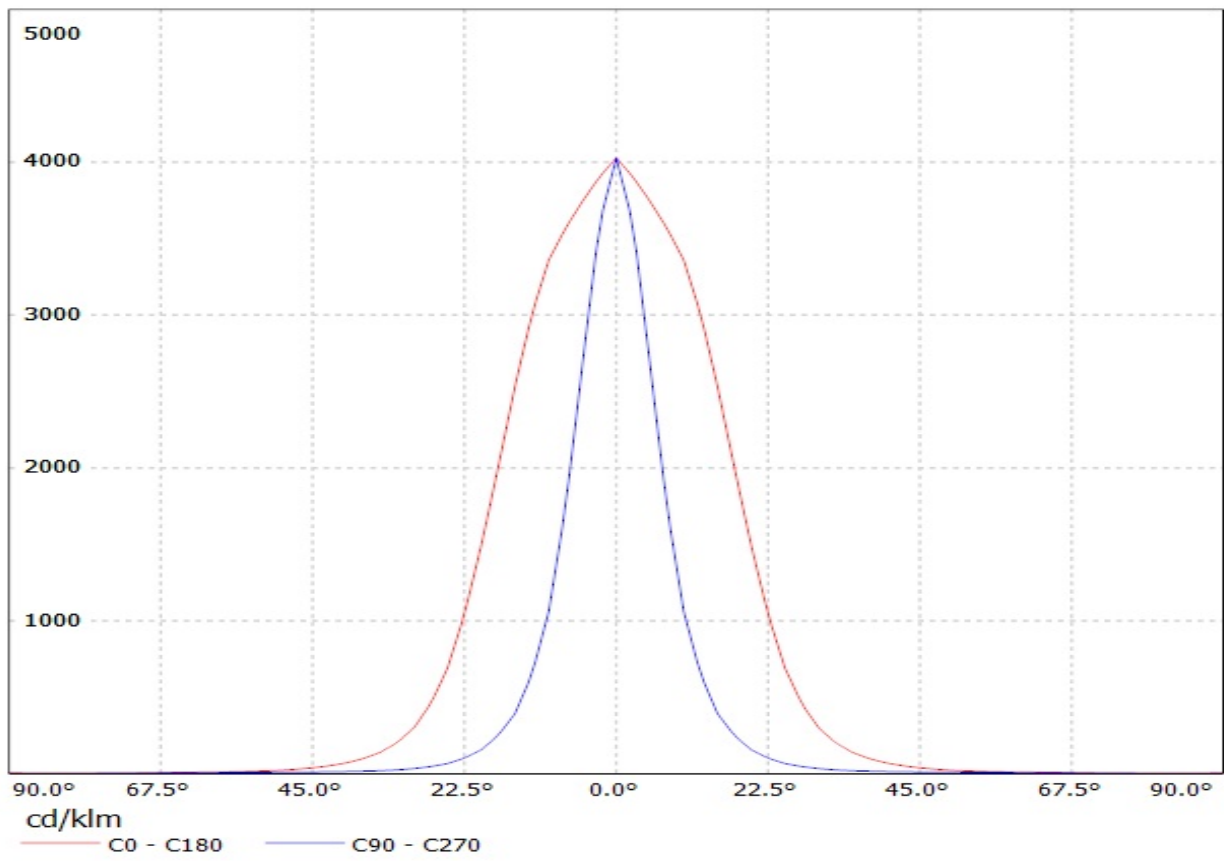

Luminaire: Ledil Oy CP12674_TINA2-W (Cree XB-D 94lm @ 250mA) Efficiency=81%
Lamps: 1 x Cree XB-D 94lm @ 250mA

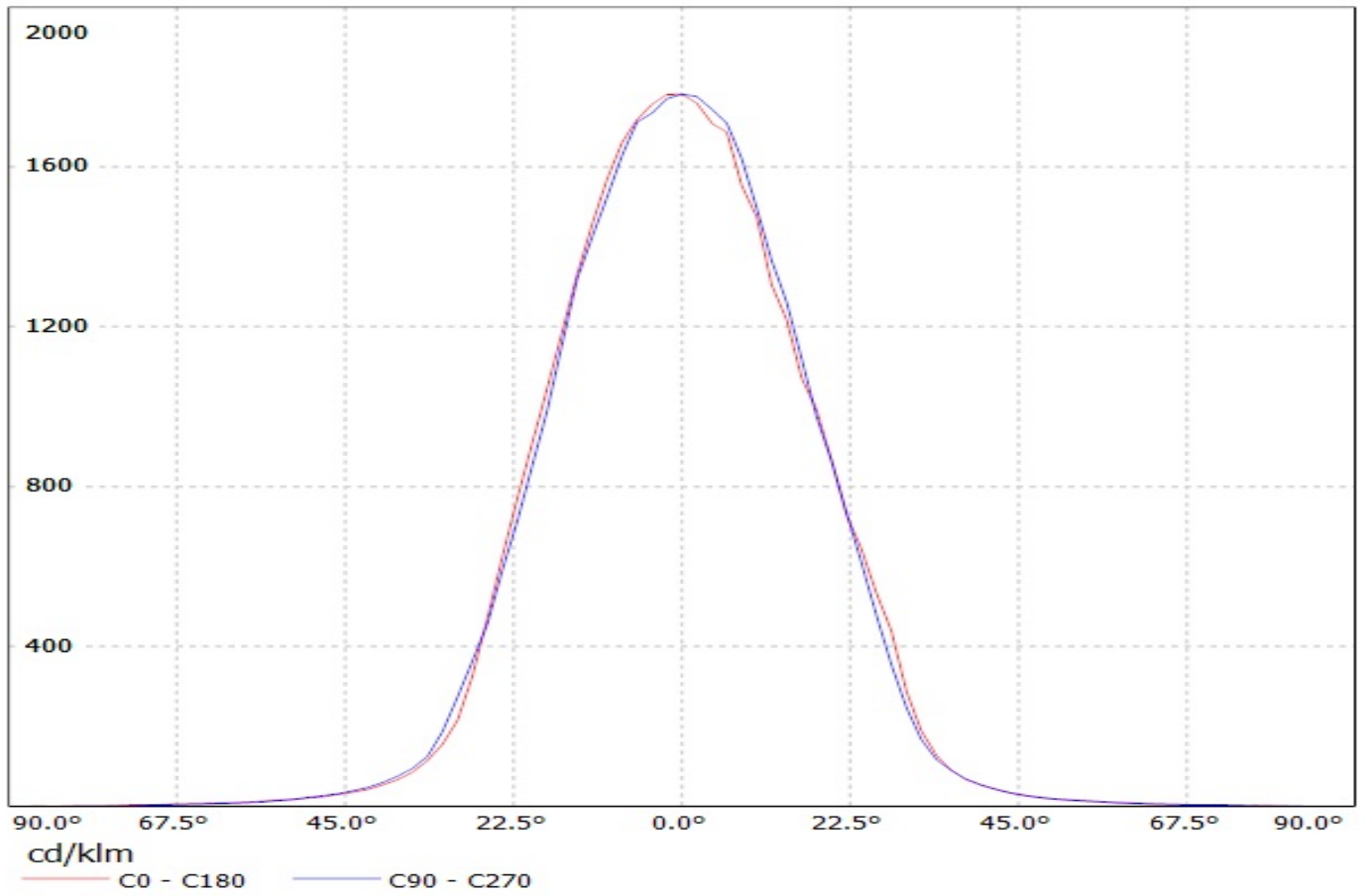

Luminaire: LEDIL OY CP12671_TINA2-D (XB-D) Efficiency=88%
Lamps: 1 x Cree XB-D white (97lm @ 250mA)

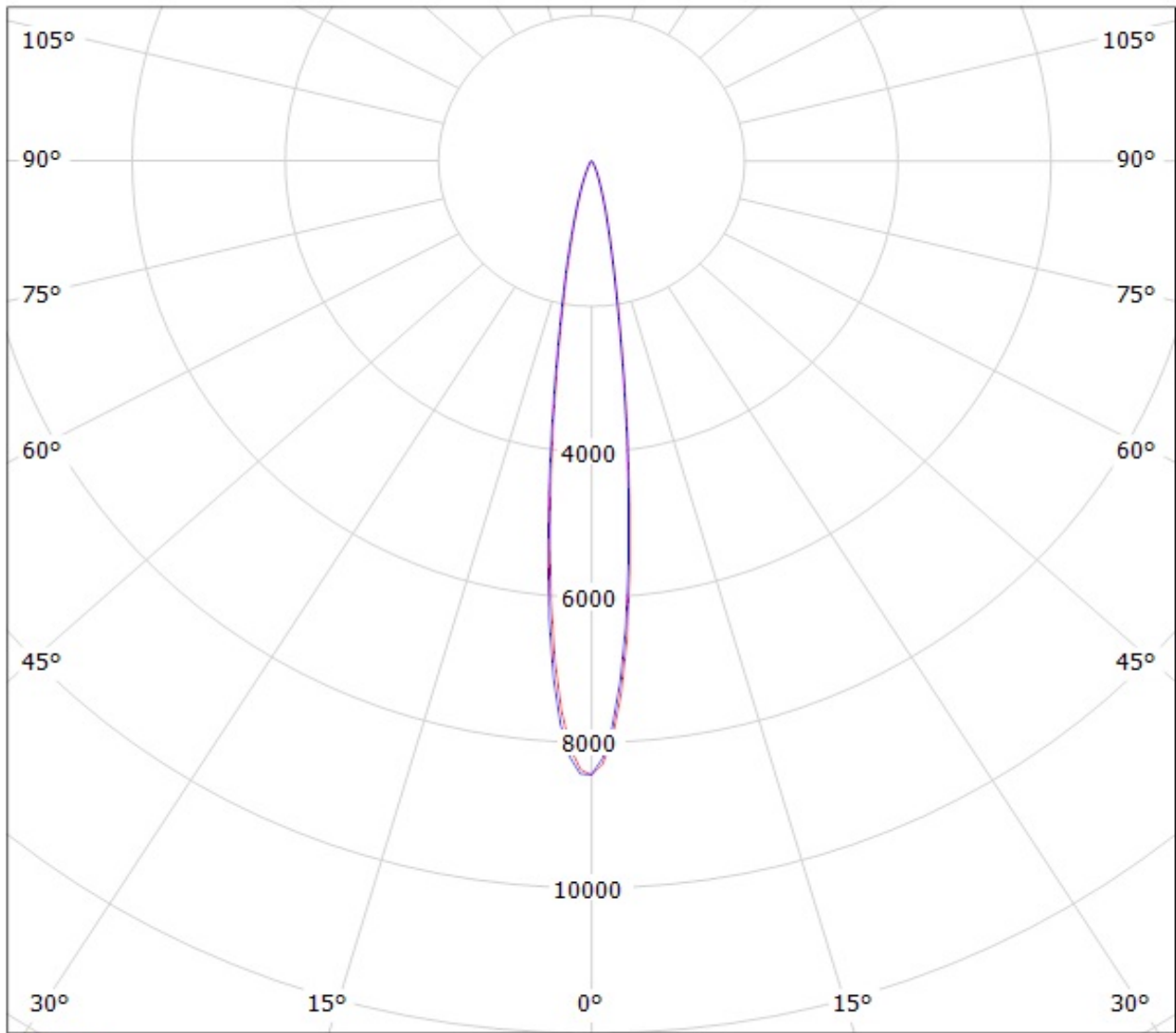

cd/klm

— C0 - C180

— C90 - C270

Luminaire: LEDIL OY CP12672_TINA2-M (XB-D) Efficiency=82%
Lamps: 1 x Cree XB-D white (97lm @ 250mA)

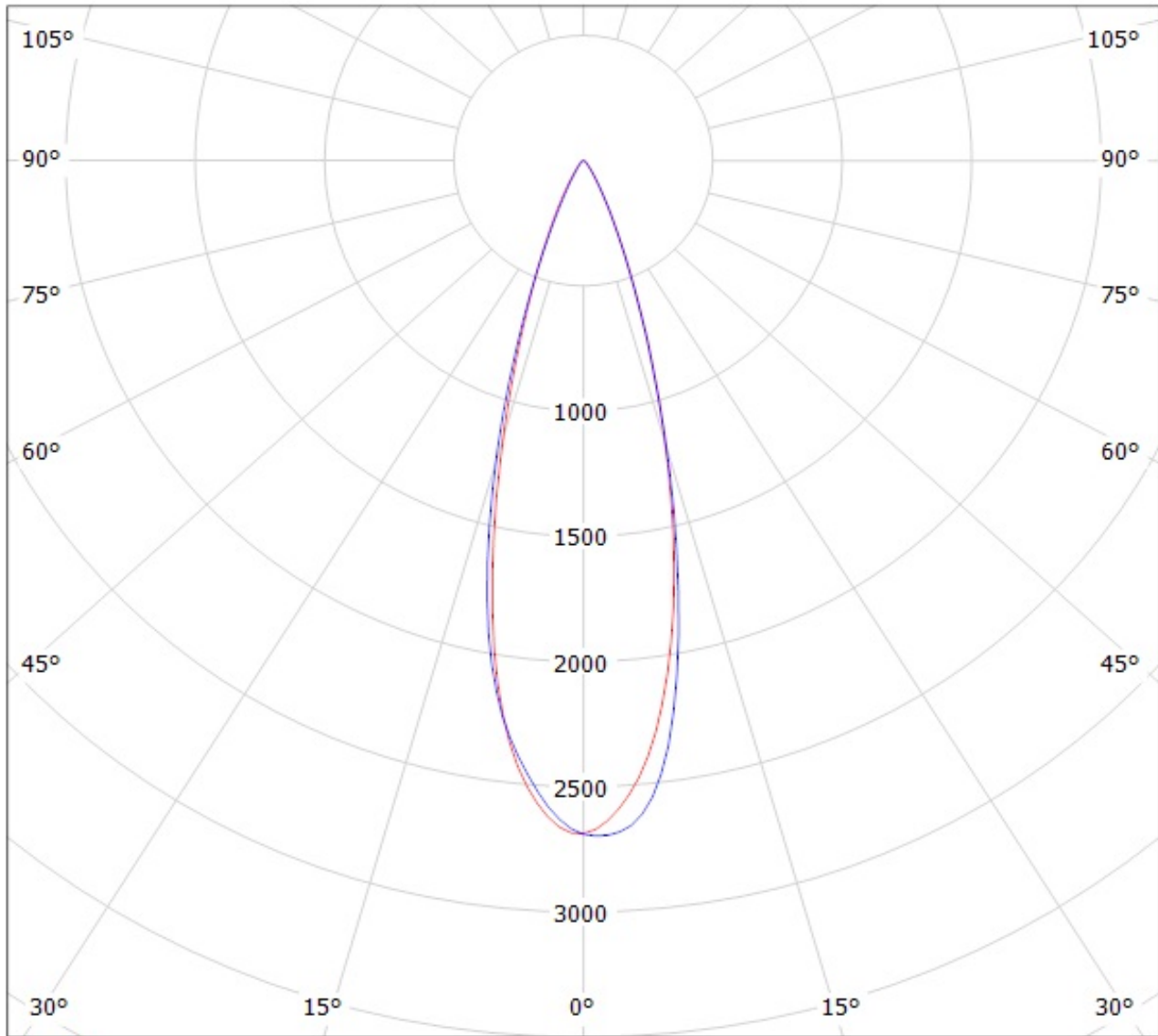

cd/klm

— C0 - C180

— C90 - C270

Luminaire: LEDIL OY CP12673_TINA2-O (XB-D) Efficiency=84%
Lamps: 1 x Cree XB-D white (97lm @ 250mA)

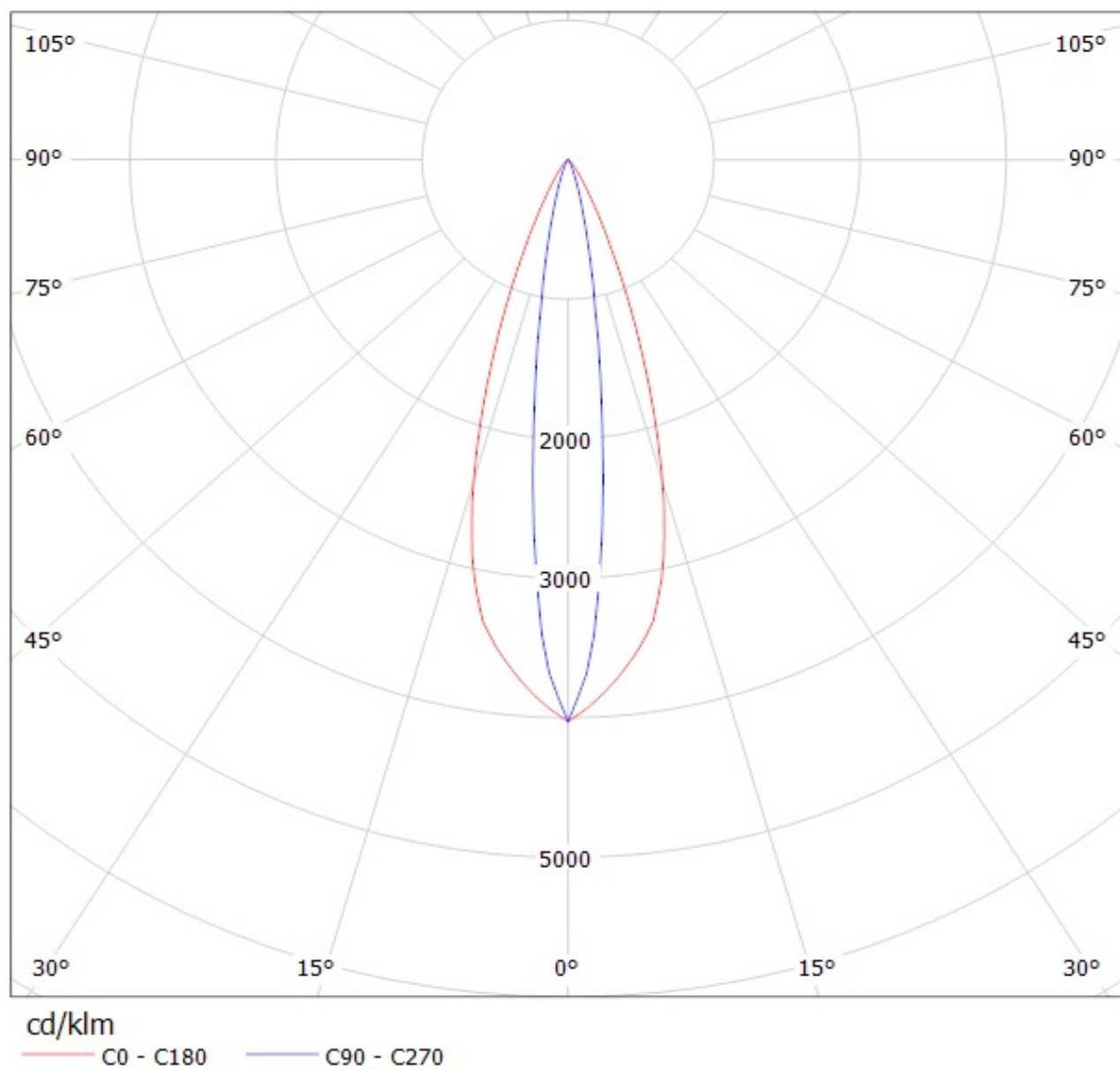

Luminaire: Ledil Oy CP12674_TINA2-W (Cree XB-D 94lm @ 250mA) Efficiency=81%
Lamps: 1 x Cree XB-D 94lm @ 250mA

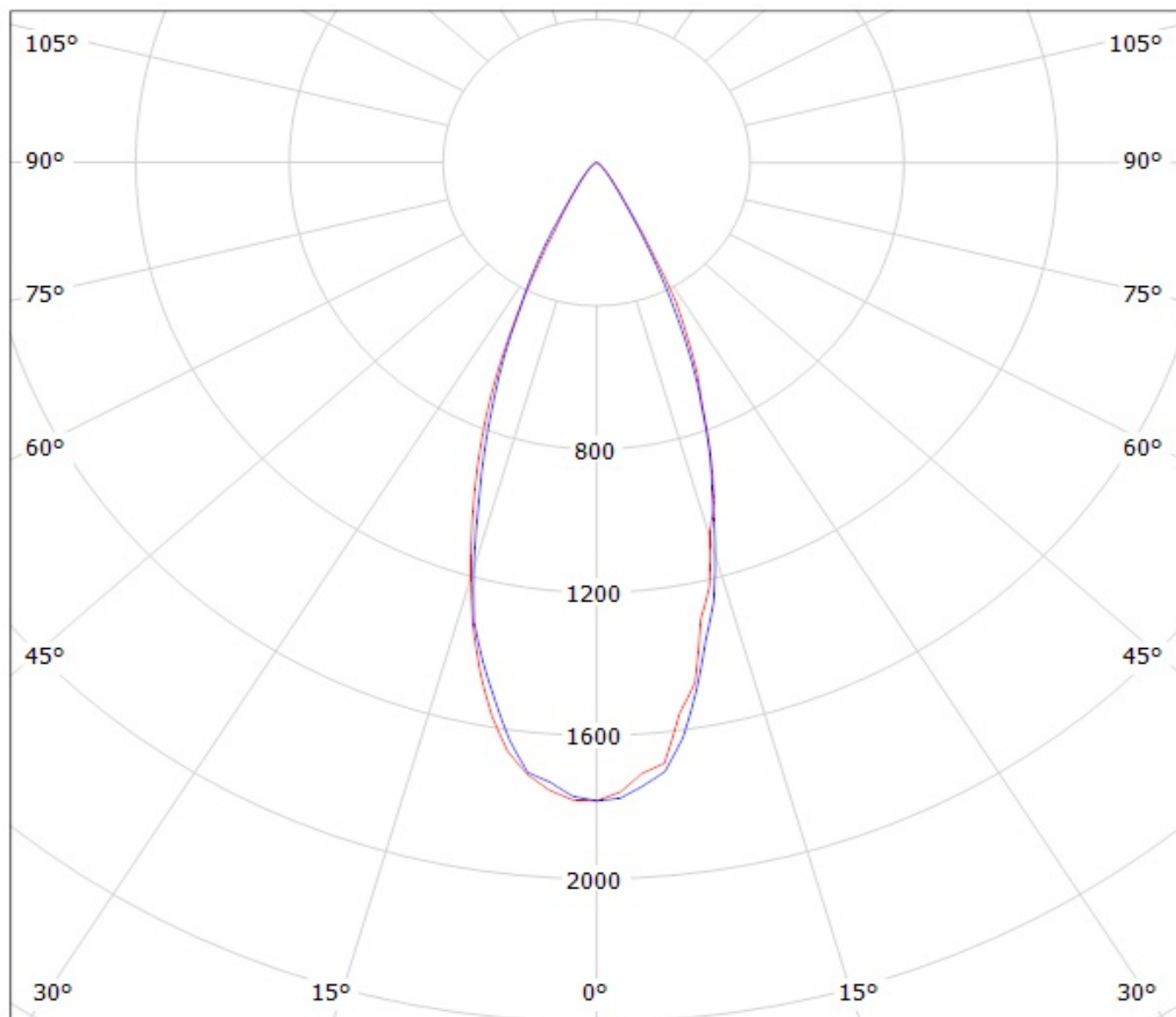

cd/klm

— C0 - C180

— C90 - C270