

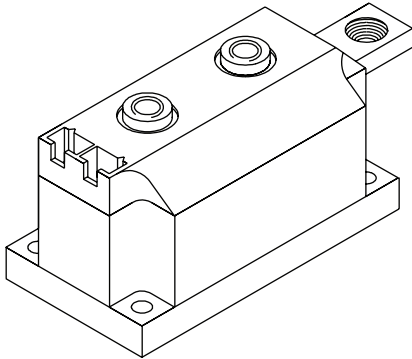

**SCR/SCR and SCR/Diode  
(MAGN-A-PAK™ Power Modules), 170/250 A**



MAGN-A-PAK™

**FEATURES**

- High voltage
- Electrically isolated base plate
- 3500 V<sub>RMS</sub> isolating voltage
- Industrial standard package
- Simplified mechanical designs, rapid assembly
- High surge capability
- Large creepage distances
- Lead (Pb)-free
- Designed and qualified for industrial level



**RoHS  
COMPLIANT**

**PRODUCT SUMMARY**

$I_{T(AV)}$	170/250 A
-------------	-----------

**DESCRIPTION**

This new VSK series of MAGN-A-PAK™ modules uses high voltage power thyristor/thyristor and thyristor/diode in seven basic configurations. The semiconductors are electrically isolated from the metal base, allowing common heatsinks and compact assemblies to be built. They can be interconnected to form single phase or three phase bridges or as AC-switches when modules are connected in anti-parallel mode. These modules are intended for general purpose applications such as battery chargers, welders, motor drives, UPS, etc.

**MAJOR RATINGS AND CHARACTERISTICS**

SYMBOL	CHARACTERISTICS	VSK.170..	VSK.250..	UNITS
$I_{T(AV)}$	85 °C	170	250	A
$I_{T(RMS)}$		377	555	
$I_{TSM}$	50 Hz	5100	8500	
	60 Hz	5350	8900	
$I^2t$	50 Hz	131	361	kA <sup>2</sup> s
	60 Hz	119	330	
$I^2\sqrt{t}$		1310	3610	kA <sup>2</sup> √s
$V_{DRM}/V_{RRM}$		Up to 1600		V
$T_J$	Range	- 40 to 130		°C

**ELECTRICAL SPECIFICATIONS**

**VOLTAGE RATINGS**

TYPE NUMBER	VOLTAGE CODE	$V_{RRM}/V_{DRM}$ , MAXIMUM REPETITIVE PEAK REVERSE AND OFF-STATE BLOCKING VOLTAGE V	$V_{RSM}$ , MAXIMUM NON-REPETITIVE PEAK REVERSE VOLTAGE V	$I_{RRM}/I_{DRM}$ AT 130 °C MAXIMUM mA
VSK.170- VSK.250-	04	400	500	50
	08	800	900	
	10	1000	1100	
	12	1200	1300	
	14	1400	1500	
	16	1600	1700	

# VSK.170PbF, .250PbF Series



Vishay High Power Products

SCR/SCR and SCR/Diode  
(MAGN-A-PAK™ Power Modules), 170/250 A

ON-STATE CONDUCTION							
PARAMETER	SYMBOL	TEST CONDITIONS		VSK.170	VSK.250	UNITS	
Maximum average on-state current at case temperature	$I_{T(AV)}$	180° conduction, half sine wave		170	250	A	
				85	85	°C	
Maximum RMS on-state current	$I_{T(RMS)}$	As AC switch		377	555	A	
Maximum peak, one-cycle on-state non-repetitive, surge current	$I_{TSM}$	t = 10 ms	No voltage reapplied	5100	8500		
		t = 8.3 ms		5350	8900		
		t = 10 ms	100 % $V_{RRM}$ reapplied	4300	7150		
		t = 8.3 ms		4500	7500		
Maximum $I^2t$ for fusing	$I^2t$	t = 10 ms	No voltage reapplied	131	361		kA <sup>2</sup> s
		t = 8.3 ms		119	330		
		t = 10 ms	100 % $V_{RRM}$ reapplied	92.5	255		
		t = 8.3 ms		84.4	233		
Maximum $I^2\sqrt{t}$ for fusing	$I^2\sqrt{t}$	t = 0.1 to 10 ms, no voltage reapplied		1310	3610	kA <sup>2</sup> √s	
Low level value or threshold voltage	$V_{T(TO)1}$	$(16.7\% \times \pi \times I_{T(AV)} < I < \pi \times I_{T(AV)})$ , $T_J = T_J$ maximum		0.89	0.97	V	
High level value of threshold voltage	$V_{T(TO)2}$	$(I > \pi \times I_{T(AV)} < I < \pi \times I_{T(AV)})$ , $T_J = T_J$ maximum		1.12	1.00		
Low level value on-state slope resistance	$r_{t1}$	$(16.7\% \times \pi \times I_{T(AV)} < I < \pi \times I_{T(AV)})$ , $T_J = T_J$ maximum		1.34	0.60	mΩ	
High level value on-state slope resistance	$r_{t2}$	$(I > \pi \times I_{T(AV)} < I < \pi \times I_{T(AV)})$ , $T_J = T_J$ maximum		0.96	0.57		
Maximum on-state voltage drop	$V_{TM}$	$I_{TM} = \pi \times I_{T(AV)}$ , $T_J = T_J$ maximum, 180° conduction, average power = $V_{T(TO)} \times I_{T(AV)} + r_f \times (I_{T(RMS)})^2$		1.60	1.44	V	
Maximum holding current	$I_H$	Anode supply = 12 V, initial $I_T = 30$ A, $T_J = 25$ °C		500	500	mA	
Maximum latching current	$I_L$	Anode supply = 12 V, resistive load = 1 Ω, gate pulse: 10 V, 100 μs, $T_J = 25$ °C		1000	1000		

SWITCHING						
PARAMETER	SYMBOL	TEST CONDITIONS		VSK.170	VSK.250	UNITS
Typical delay time	$t_d$	$T_J = 25$ °C, gate current = 1 A $dI_g/dt = 1$ A/μs $V_d = 0.67\% V_{DRM}$		1.0		μs
Typical rise time	$t_r$			2.0		
Typical turn-off time	$t_q$	$I_{TM} = 300$ A; $dI/dt = 15$ A/μs; $T_J = T_J$ maximum; $V_R = 50$ V; $dV/dt = 20$ V/μs; gate 0 V, 100 Ω		50 - 150		

BLOCKING						
PARAMETER	SYMBOL	TEST CONDITIONS		VSK.170	VSK.250	UNITS
Maximum peak reverse and off-state leakage current	$I_{RRM}$ , $I_{DRM}$	$T_J = T_J$ maximum		50		mA
RMS insulation voltage	$V_{INS}$	50 Hz, circuit to base, all terminals shorted, 25 °C, 1 s		3000		V
Critical rate of rise of off-state voltage	$dV/dt$	$T_J = T_J$ maximum, exponential to 67 % rated $V_{DRM}$		1000		V/μs



# VSK.170PbF, .250PbF Series

SCR/SCR and SCR/Diode  
(MAGN-A-PAK™ Power Modules), 170/250 A

Vishay High Power Products

TRIGGERING					
PARAMETER	SYMBOL	TEST CONDITIONS	VSK.170	VSK.250	UNITS
Maximum peak gate power	$P_{GM}$	$t_p \leq 5$ ms, $T_J = T_J$ maximum	10.0		W
Maximum average gate power	$P_{G(AV)}$	$f = 50$ Hz, $T_J = T_J$ maximum	2.0		
Maximum peak gate current	$+I_{GM}$	$t_p \leq 5$ ms, $T_J = T_J$ maximum	3.0		A
Maximum peak negative gate voltage	$-V_{GT}$	$t_p \leq 5$ ms, $T_J = T_J$ maximum	5.0		V
Maximum required DC gate voltage to trigger	$V_{GT}$	$T_J = -40$ °C	Anode supply = 12 V, resistive load; $R_a = 1$ $\Omega$	4.0	
		$T_J = 25$ °C		3.0	
		$T_J = T_J$ maximum		2.0	
Maximum required DC gate current to trigger	$I_{GT}$	$T_J = -40$ °C	Anode supply = 12 V, resistive load; $R_a = 1$ $\Omega$	350	mA
		$T_J = 25$ °C		200	
		$T_J = T_J$ maximum		100	
Maximum gate voltage that will not trigger	$V_{GD}$	$T_J = T_J$ maximum, rated $V_{DRM}$ applied	0.25		V
Maximum gate current that will not trigger	$I_{GD}$	$T_J = T_J$ maximum, rated $V_{DRM}$ applied	10.0		mA
Maximum rate of rise of turned-on current	di/dt	$T_J = T_J$ maximum, $I_{TM} = 400$ A, rated $V_{DRM}$ applied	500		A/ $\mu$ s

THERMAL AND MECHANICAL SPECIFICATIONS					
PARAMETER	SYMBOL	TEST CONDITIONS	VSK.170	VSK.250	UNITS
Junction operating temperature range	$T_J$		- 40 to 130		°C
Storage temperature range	$T_{Stg}$		- 40 to 150		
Maximum thermal resistance, junction to case per junction	$R_{thJC}$	DC operation	0.17	0.125	K/W
Typical thermal resistance, case to heatsink per module	$R_{thCS}$	Mounting surface flat, smooth and greased	0.02	0.02	
Mounting torque $\pm 10$ %	MAP to heatsink busbar to MAP	A mounting compound is recommended and the torque should be rechecked after a period of about 3 hours to allow for the spread of the compound.	4 to 6		Nm
Approximate weight			500		g
			17.8		oz.
Case style			MAGN-A-PAK		

$\Delta R$ CONDUCTION PER JUNCTION											
DEVICES	SINUSOIDAL CONDUCTION AT $T_J$ MAXIMUM					RECTANGULAR CONDUCTION AT $T_J$ MAXIMUM					UNITS
	180°	120°	90°	60°	30°	180°	120°	90°	60°	30°	
VSK.170-	0.009	0.010	0.010	0.020	0.032	0.007	0.011	0.015	0.020	0.033	K/W
VSK.250-	0.009	0.010	0.014	0.020	0.032	0.007	0.011	0.015	0.020	0.033	

**Note**

- Table shows the increment of thermal resistance  $R_{thJC}$  when devices operate at different conduction angles than DC

# VSK.170PbF, .250PbF Series



Vishay High Power Products

SCR/SCR and SCR/Diode  
(MAGN-A-PAK™ Power Modules), 170/250 A

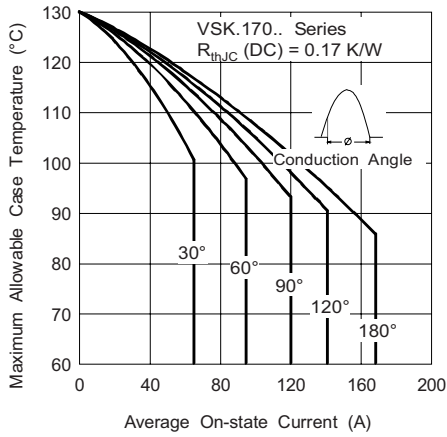

Fig. 1 - Current Ratings Characteristics

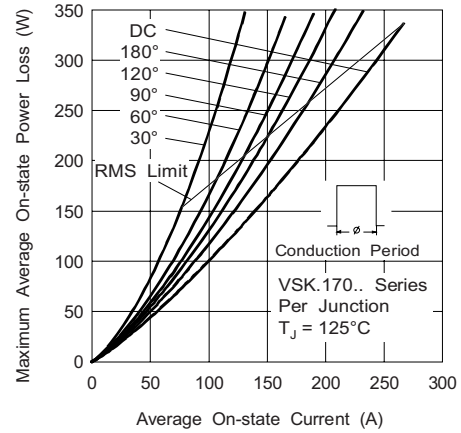

Fig. 4 - On-State Power Loss Characteristics

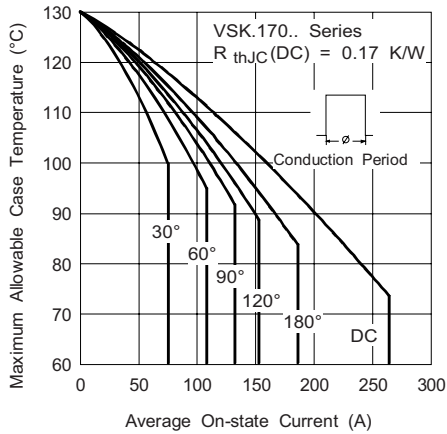

Fig. 2 - Current Ratings Characteristics

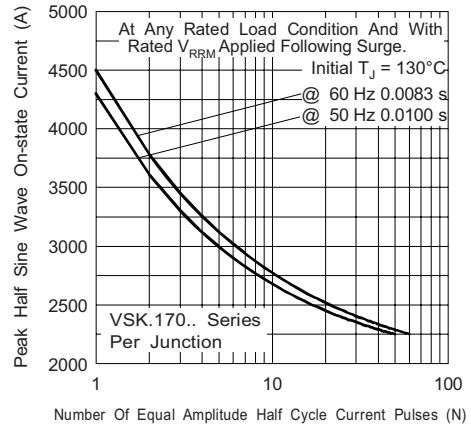

Fig. 5 - Maximum Non-Repetitive Surge Current

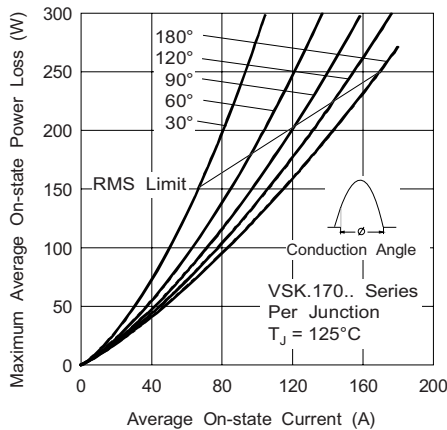

Fig. 3 - On-State Power Loss Characteristics

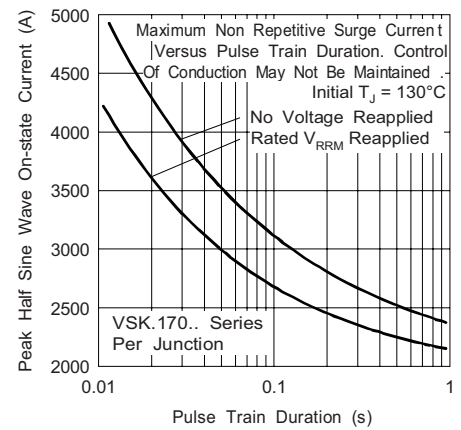

Fig. 6 - Maximum Non-Repetitive Surge Current



# VSK.170PbF, .250PbF Series

SCR/SCR and SCR/Diode  
(MAGN-A-PAK™ Power Modules), 170/250 A

Vishay High Power Products

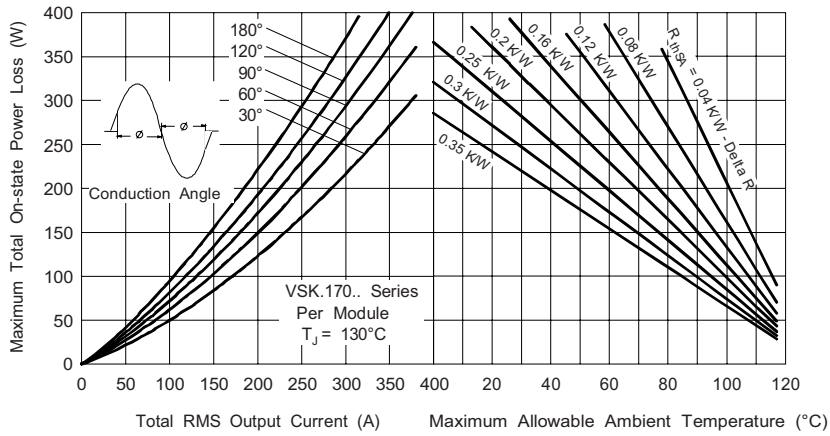

Fig. 7 - On-State Power Loss Characteristics

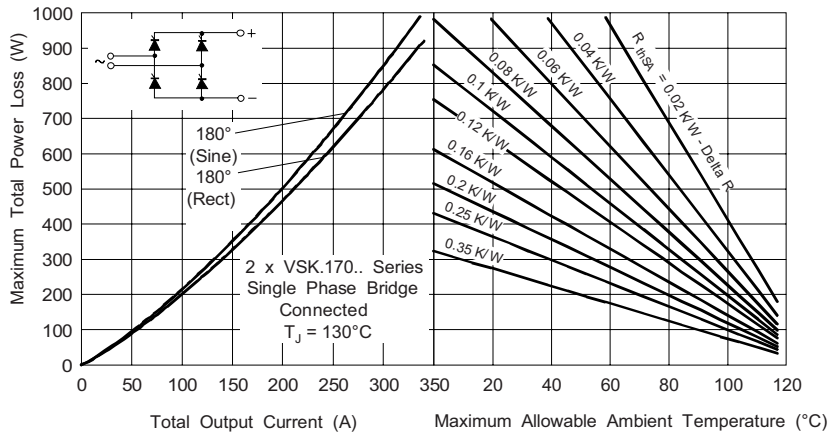

Fig. 8 - On-State Power Loss Characteristics

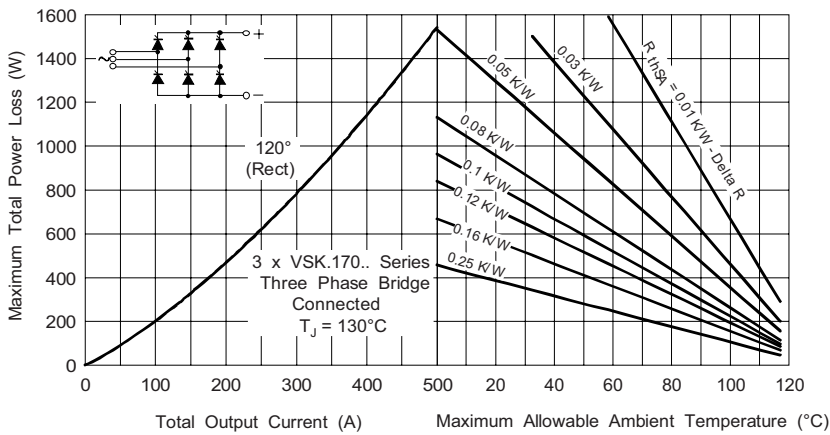

Fig. 9 - On-State Power Loss Characteristics

# VSK.170PbF, .250PbF Series



Vishay High Power Products

SCR/SCR and SCR/Diode  
(MAGN-A-PAK™ Power Modules), 170/250 A

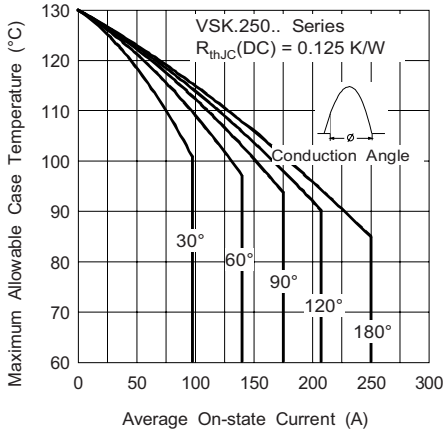

Fig. 10 - Current Ratings Characteristics

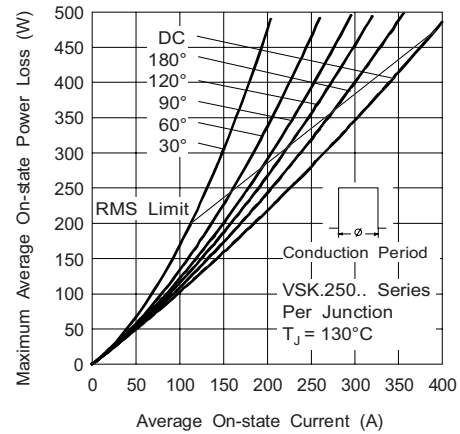

Fig. 13 - On-State Power Loss Characteristics

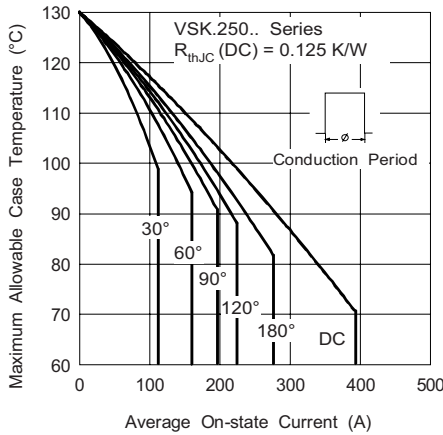

Fig. 11 - Current Ratings Characteristics

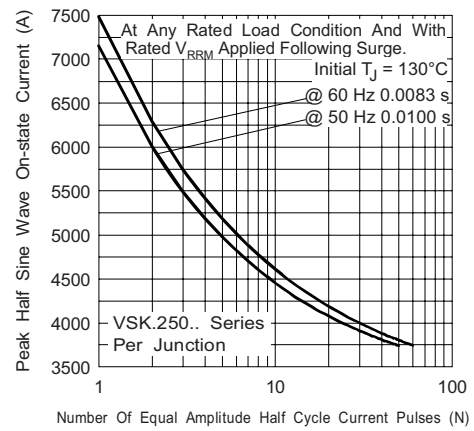

Fig. 14 - Maximum Non-Repetitive Surge Current

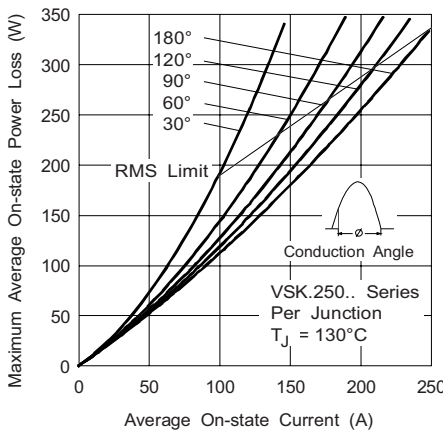

Fig. 12 - On-State Power Loss Characteristics

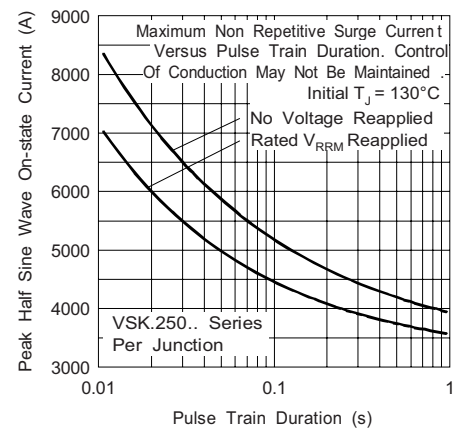

Fig. 15 - Maximum Non-Repetitive Surge Current



# VSK.170PbF, .250PbF Series

SCR/SCR and SCR/Diode  
(MAGN-A-PAK™ Power Modules), 170/250 A

Vishay High Power Products

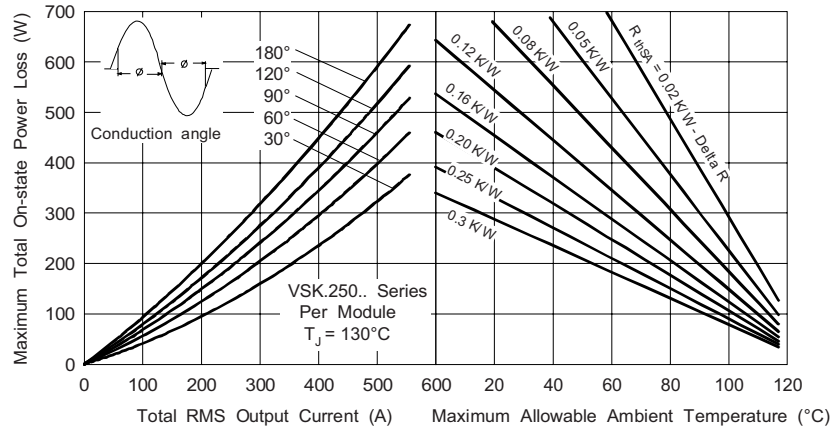

Fig. 16 - On-State Power Loss Characteristics

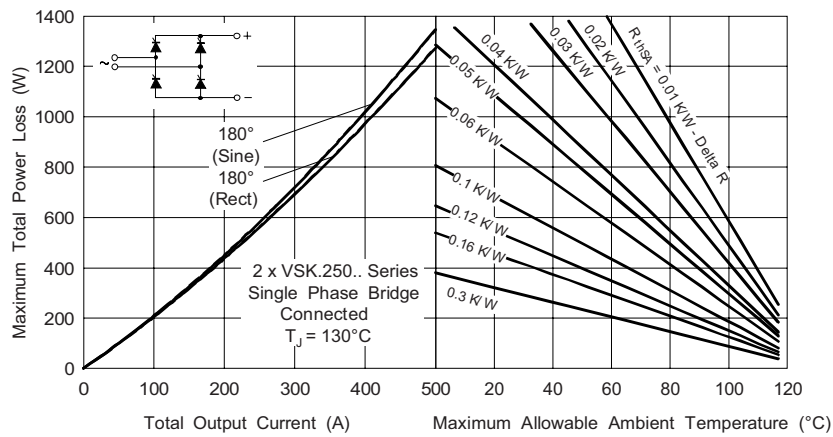

Fig. 17 - On-State Power Loss Characteristics

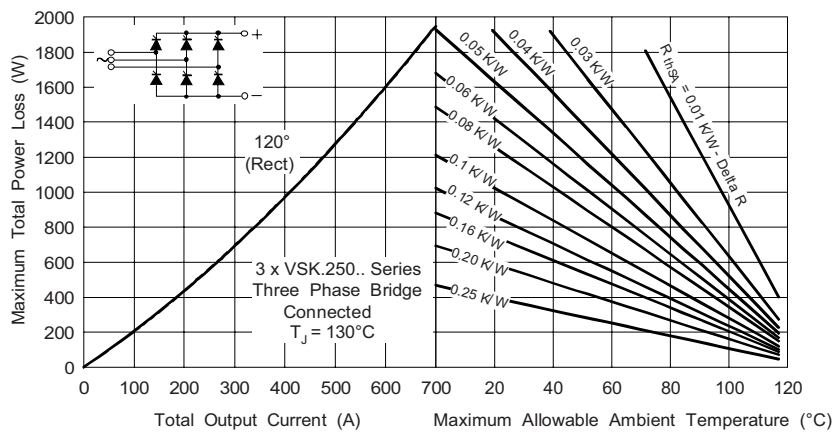

Fig. 18 - On-State Power Loss Characteristics

# VSK.170PbF, .250PbF Series



Vishay High Power Products

SCR/SCR and SCR/Diode  
(MAGN-A-PAK™ Power Modules), 170/250 A

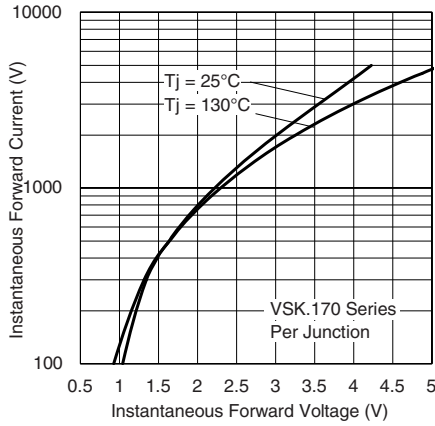

Fig. 19 - On-State Voltage Drop Characteristics

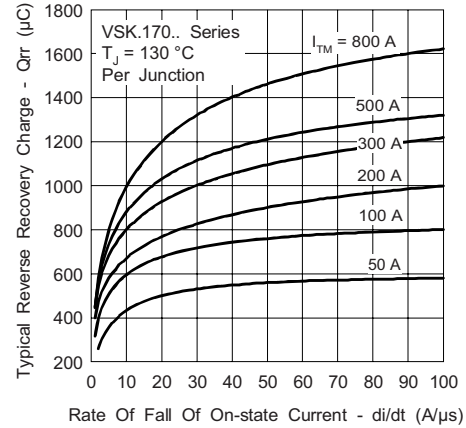

Fig. 21 - Reverse Recovery Charge Characteristics

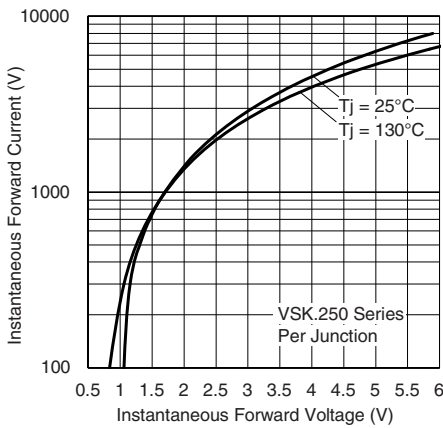

Fig. 20 - On-State Voltage Drop Characteristics

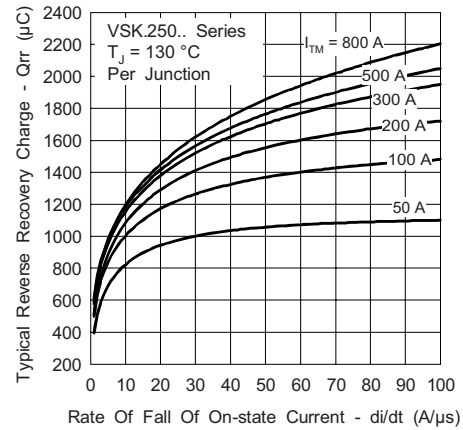

Fig. 22 - Reverse Recovery Charge Characteristics

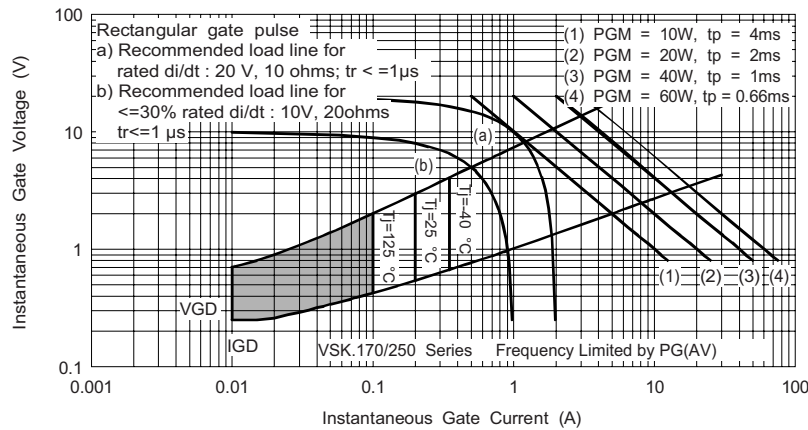

Fig. 23 - Gate Characteristics





# VSK.170PbF, .250PbF Series



Vishay High Power Products

SCR/SCR and SCR/Diode  
(MAGN-A-PAK™ Power Modules), 170/250 A

## CIRCUIT CONFIGURATION

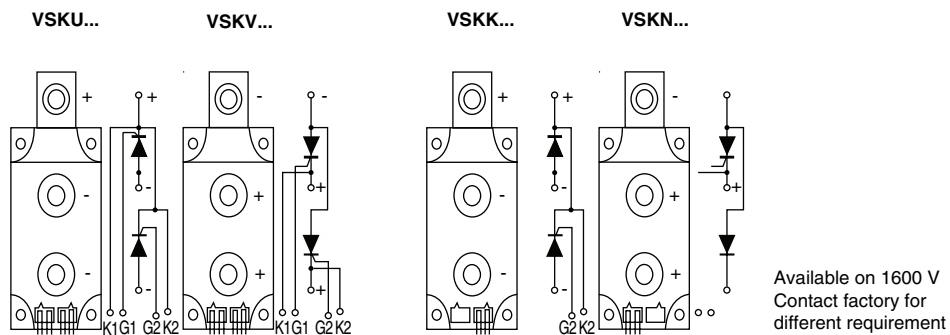
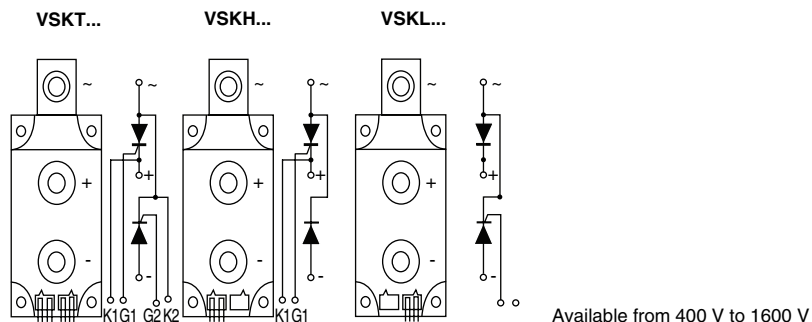

### LINKS TO RELATED DOCUMENTS

Dimensions	<a href="http://www.vishay.com/doc?95086">http://www.vishay.com/doc?95086</a>
------------	---



## Disclaimer

All product specifications and data are subject to change without notice.

Vishay Intertechnology, Inc., its affiliates, agents, and employees, and all persons acting on its or their behalf (collectively, "Vishay"), disclaim any and all liability for any errors, inaccuracies or incompleteness contained herein or in any other disclosure relating to any product.

Vishay disclaims any and all liability arising out of the use or application of any product described herein or of any information provided herein to the maximum extent permitted by law. The product specifications do not expand or otherwise modify Vishay's terms and conditions of purchase, including but not limited to the warranty expressed therein, which apply to these products.

No license, express or implied, by estoppel or otherwise, to any intellectual property rights is granted by this document or by any conduct of Vishay.

The products shown herein are not designed for use in medical, life-saving, or life-sustaining applications unless otherwise expressly indicated. Customers using or selling Vishay products not expressly indicated for use in such applications do so entirely at their own risk and agree to fully indemnify Vishay for any damages arising or resulting from such use or sale. Please contact authorized Vishay personnel to obtain written terms and conditions regarding products designed for such applications.

Product names and markings noted herein may be trademarks of their respective owners.