

**Buck chopper  
Trench + Field Stop IGBT  
Power Module**

**$V_{CES} = 600V$   
 $I_C = 200A @ T_c = 100^\circ C$**

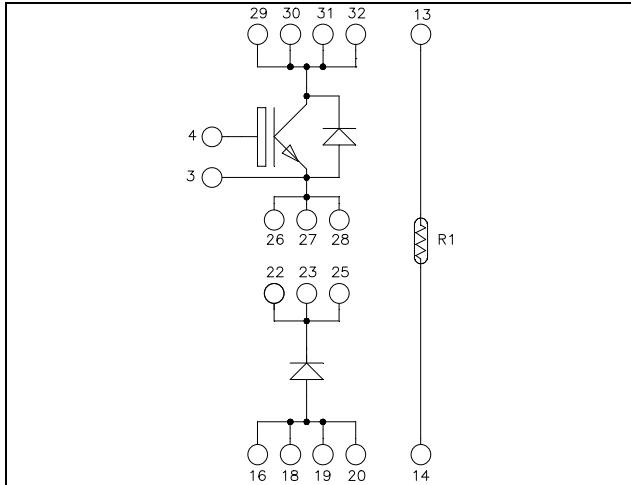

### Application

- AC and DC motor control
- Switched Mode Power Supplies

### Features

- Trench + Field Stop IGBT Technology
  - Low voltage drop
  - Low tail current
  - Switching frequency up to 20 kHz
  - Soft recovery parallel diodes
  - Low diode VF
  - Low leakage current
  - RBSOA and SCSOA rated
- Very low stray inductance
- Kelvin emitter for easy drive
- Internal thermistor for temperature monitoring
- High level of integration
- AlN substrate for improved thermal performance

### Benefits

- Direct mounting to heatsink (isolated package)
- Low junction to case thermal resistance
- Solderable terminals both for power and signal for easy PCB mounting
- Low profile
- RoHS Compliant

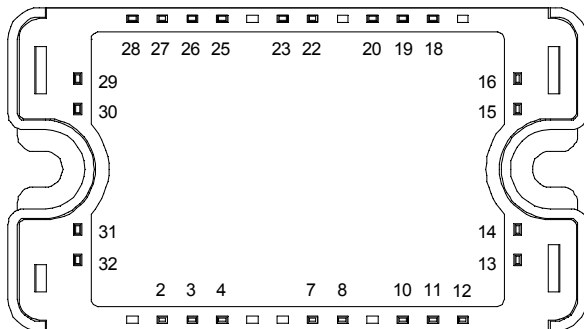

Pins 29/30/31/32 must be shorted together

Pins 26/27/28/22/23/25 must be shorted together  
to achieve a phase leg

Pins 16/18/19/20 must be shorted together

### Absolute maximum ratings

Symbol	Parameter	Max ratings	Unit
$V_{CES}$	Collector - Emitter Breakdown Voltage	600	V
$I_C$	Continuous Collector Current	$T_C = 25^\circ C$	290
		$T_C = 100^\circ C$	200
$I_{CM}$	Pulsed Collector Current	$T_C = 25^\circ C$	400
$V_{GE}$	Gate - Emitter Voltage	$\pm 20$	V
$P_D$	Maximum Power Dissipation	$T_C = 25^\circ C$	750
RBSOA	Reverse Bias Safe Operating Area	$T_j = 150^\circ C$	400A @ 550V

**CAUTION:** These Devices are sensitive to Electrostatic Discharge. Proper Handling Procedures Should Be Followed. See application note APT0502 on [www.microsemi.com](http://www.microsemi.com)

All ratings @  $T_j = 25^\circ\text{C}$  unless otherwise specified

**Electrical Characteristics**

Symbol	Characteristic	Test Conditions	Min	Typ	Max	Unit
$I_{CES}$	Zero Gate Voltage Collector Current	$V_{GE} = 0V, V_{CE} = 600V$			250	$\mu\text{A}$
$V_{CE(sat)}$	Collector Emitter Saturation Voltage	$V_{GE} = 15V$ $I_C = 200A$	$T_j = 25^\circ\text{C}$	1.5	1.9	V
			$T_j = 150^\circ\text{C}$	1.7		
$V_{GE(th)}$	Gate Threshold Voltage	$V_{GE} = V_{CE}, I_C = 2\text{ mA}$	5.0	5.8	6.5	V
$I_{GES}$	Gate – Emitter Leakage Current	$V_{GE} = 20V, V_{CE} = 0V$			400	nA

**Dynamic Characteristics**

Symbol	Characteristic	Test Conditions	Min	Typ	Max	Unit
$C_{ies}$	Input Capacitance	$V_{GE} = 0V$		12.3		nF
$C_{oes}$	Output Capacitance	$V_{CE} = 25V$		0.8		
$C_{res}$	Reverse Transfer Capacitance	$f = 1\text{MHz}$		0.4		
$Q_G$	Gate charge	$V_{GE} = \pm 15V ; V_{CE} = 300V$ $I_C = 200A$		2.2		$\mu\text{C}$
$T_{d(on)}$	Turn-on Delay Time	Inductive Switching ( $25^\circ\text{C}$ ) $V_{GE} = \pm 15V$ $V_{Bus} = 300V$ $I_C = 200A$ $R_G = 2\Omega$		115		ns
$T_r$	Rise Time			45		
$T_{d(off)}$	Turn-off Delay Time			225		
$T_f$	Fall Time			55		
$T_{d(on)}$	Turn-on Delay Time	Inductive Switching ( $150^\circ\text{C}$ ) $V_{GE} = \pm 15V$ $V_{Bus} = 300V$ $I_C = 200A$ $R_G = 2\Omega$		130		ns
$T_r$	Rise Time			50		
$T_{d(off)}$	Turn-off Delay Time			300		
$T_f$	Fall Time			70		
$E_{on}$	Turn on Energy	$V_{GE} = \pm 15V$ $V_{Bus} = 300V$ $I_C = 200A$	$T_j = 25^\circ\text{C}$	1		mJ
			$T_j = 150^\circ\text{C}$	1.8		
$E_{off}$	Turn off Energy	$R_G = 2\Omega$	$T_j = 25^\circ\text{C}$	5.7		mJ
			$T_j = 150^\circ\text{C}$	7		
$I_{sc}$	Short Circuit data	$V_{GE} \leq 15V ; V_{Bus} = 360V$ $t_p \leq 6\mu\text{s} ; T_j = 150^\circ\text{C}$		1000		A

**Chopper diode ratings and characteristics**

Symbol	Characteristic	Test Conditions	Min	Typ	Max	Unit
$V_{RRM}$	Maximum Peak Repetitive Reverse Voltage		600			V
$I_{RM}$	Maximum Reverse Leakage Current	$V_R = 600V$	$T_j = 25^\circ\text{C}$		250	$\mu\text{A}$
			$T_j = 150^\circ\text{C}$		500	
$I_F$	DC Forward Current		$T_c = 80^\circ\text{C}$	200		A
$V_F$	Diode Forward Voltage	$I_F = 200A$ $V_{GE} = 0V$	$T_j = 25^\circ\text{C}$	1.6	2	V
			$T_j = 150^\circ\text{C}$	1.5		
$t_{rr}$	Reverse Recovery Time	$I_F = 200A$ $V_R = 300V$ $di/dt = 2800A/\mu\text{s}$	$T_j = 25^\circ\text{C}$	125		ns
			$T_j = 150^\circ\text{C}$	220		
$Q_{rr}$	Reverse Recovery Charge		$T_j = 25^\circ\text{C}$	9		$\mu\text{C}$
			$T_j = 150^\circ\text{C}$	20		
$E_r$	Reverse Recovery Energy		$T_j = 25^\circ\text{C}$	2.2		mJ
			$T_j = 150^\circ\text{C}$	4.8		

## Thermal and package characteristics

Symbol	Characteristic	Min	Typ	Max	Unit	
R <sub>thJC</sub>	Junction to Case Thermal Resistance	IGBT		0.20	°C/W	
		Diode		0.31		
V <sub>ISOL</sub>	RMS Isolation Voltage, any terminal to case t=1 min, I <sub>isol</sub> <1mA, 50/60Hz	2500			V	
T <sub>J</sub>	Operating junction temperature range	-40		175	°C	
T <sub>STG</sub>	Storage Temperature Range	-40		125		
T <sub>C</sub>	Operating Case Temperature	-40		100		
Torque	Mounting torque	To heatsink	M4	2.5	4.7	N.m
Wt	Package Weight				110	g

## Temperature sensor NTC (see application note APT0406 on www.microsemi.com for more information).

Symbol	Characteristic	Min	Typ	Max	Unit
R <sub>25</sub>	Resistance @ 25°C		50		kΩ
ΔR <sub>25</sub> /R <sub>25</sub>			5		%
B <sub>25/85</sub>	T <sub>25</sub> = 298.15 K		3952		K
ΔB/B	T <sub>C</sub> = 100°C		4		%

$$R_T = \frac{R_{25}}{\exp\left[B_{25/85}\left(\frac{1}{T_{25}} - \frac{1}{T}\right)\right]}$$

T: Thermistor temperature  
 R<sub>T</sub>: Thermistor value at T

## SP3 Package outline (dimensions in mm)

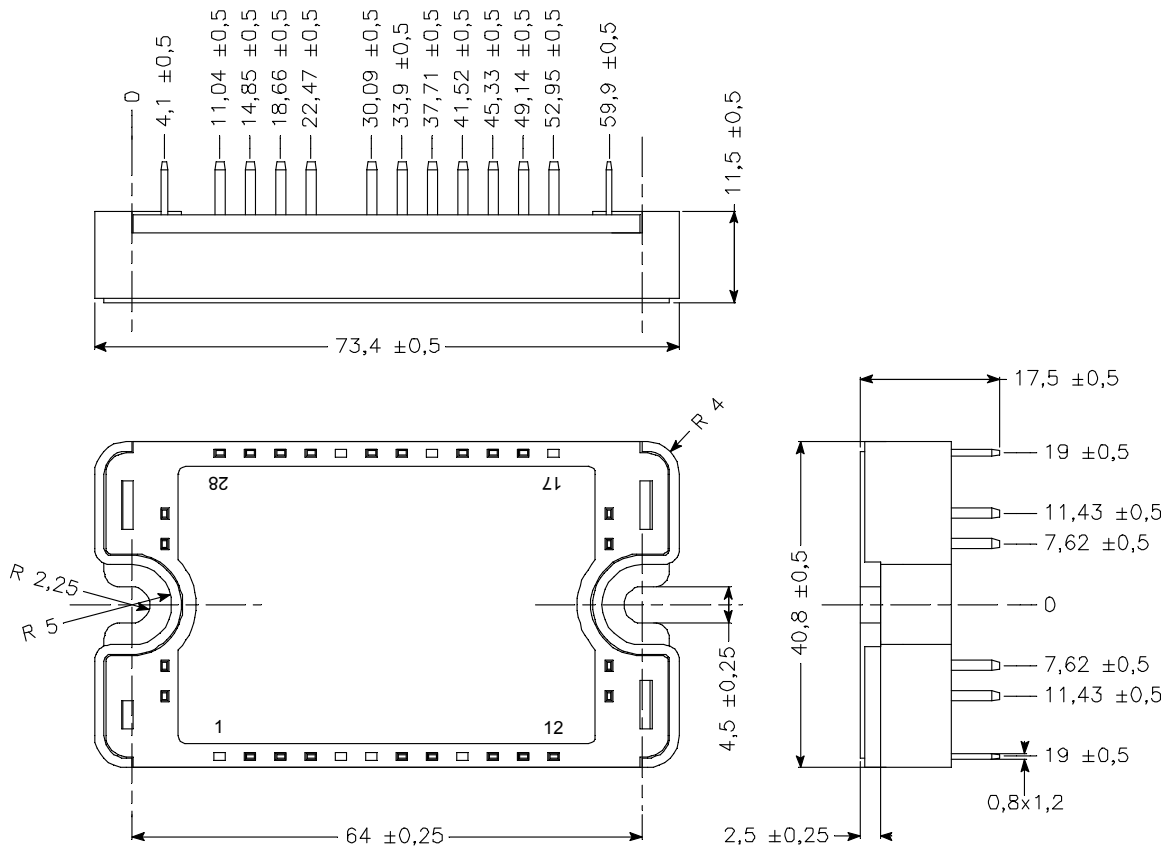

See application note 1901 - Mounting Instructions for SP3 Power Modules on [www.microsemi.com](http://www.microsemi.com)

## Typical Performance Curve

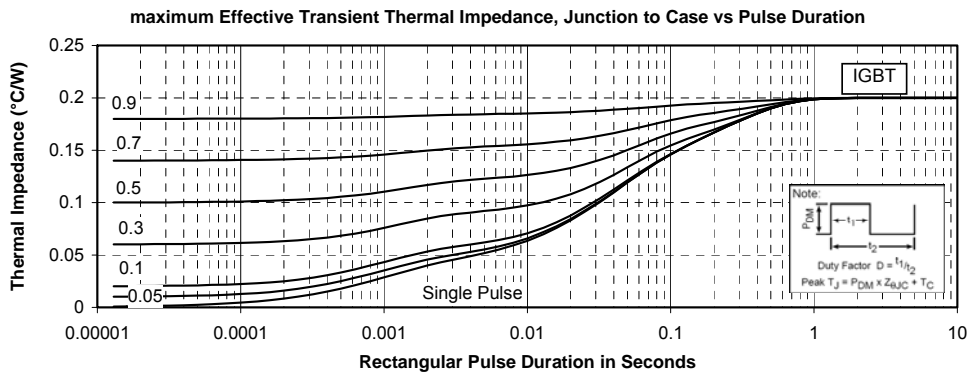
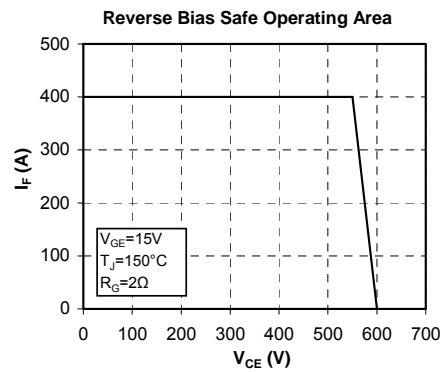
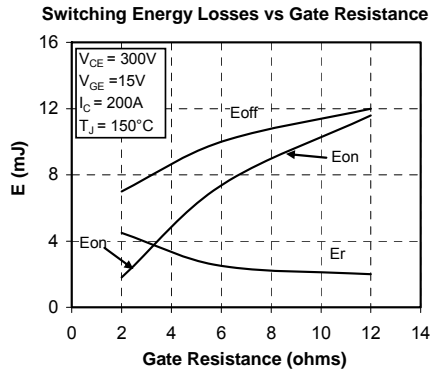
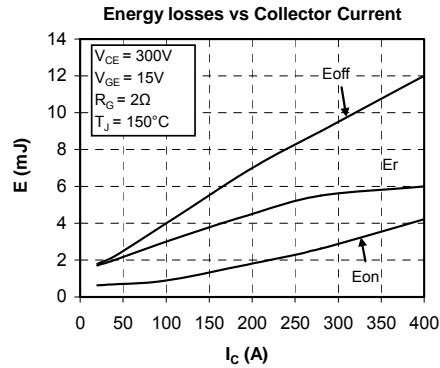
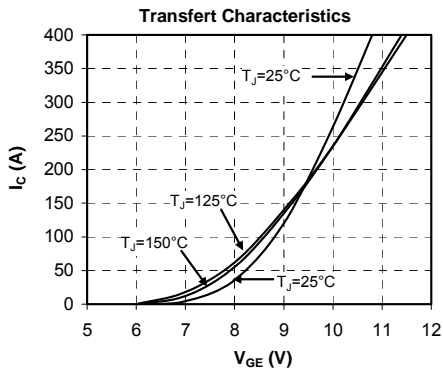
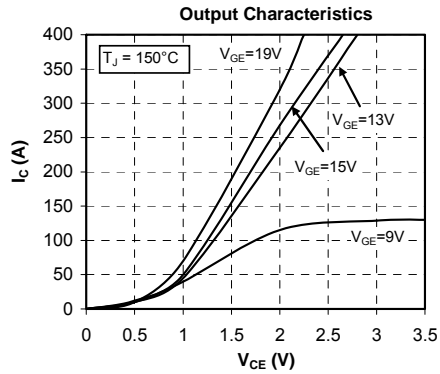
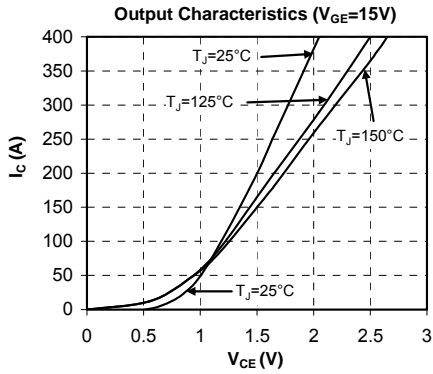

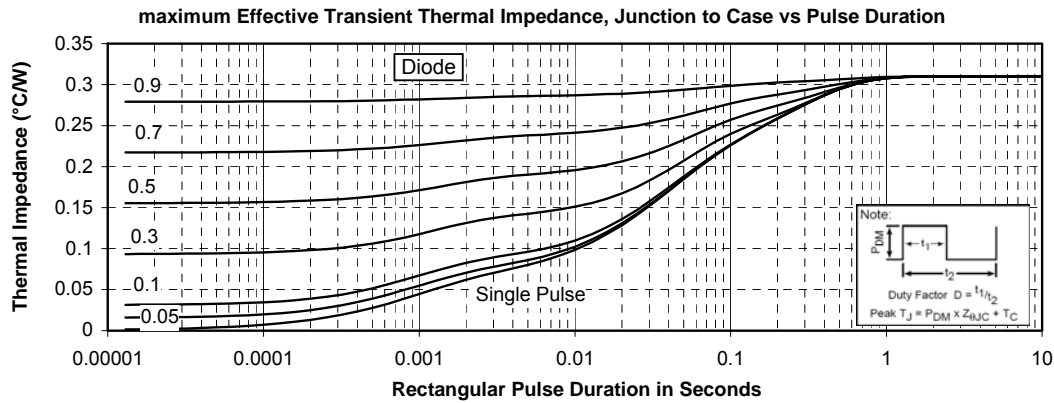
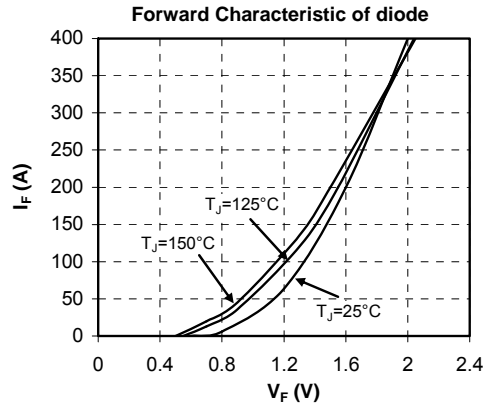
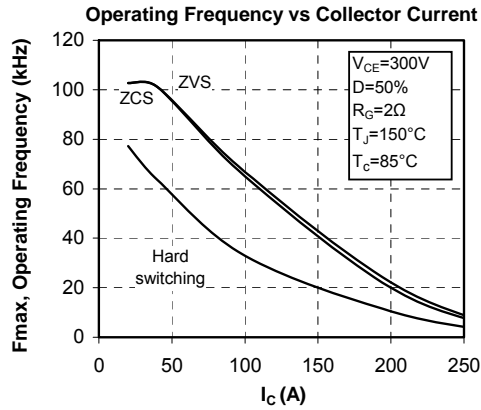

Microsemi reserves the right to change, without notice, the specifications and information contained herein

Microsemi's products are covered by one or more of U.S. patents 4,895,810 5,045,903 5,089,434 5,182,234 5,019,522 5,262,336 6,503,786 5,256,583 4,748,103 5,283,202 5,231,474 5,434,095 5,528,058 6,939,743 7,352,045 5,283,201 5,801,417 5,648,283 7,196,634 6,664,594 7,157,886 6,939,743 7,342,262 and foreign patents. U.S and Foreign patents pending. All Rights Reserved.