



CT-100A

PA25519A01
REV: 00 11-2007

CRIMPING TOOL OPERATION INSTRUCTIONS

© Panduit Corp. 2007

CT-100A CRIMPING TOOL

OPERATION INSTRUCTIONS

See product packaging or contact Customer Service for UL/CSA approved tooling/product combination.

NOTE: In the interest of higher quality and value, PANDUIT products are continually being improved and updated. Consequently, pictures may vary from the enclosed product.



WARNING:

Electric Shock Hazard:

Do NOT use this tool on live wire.

Verify power is "OFF" before working on wiring with this tool.

The plastic grips are for the user's comfort, and are not intended to insulate against electrical shock while working on live electrical circuits.

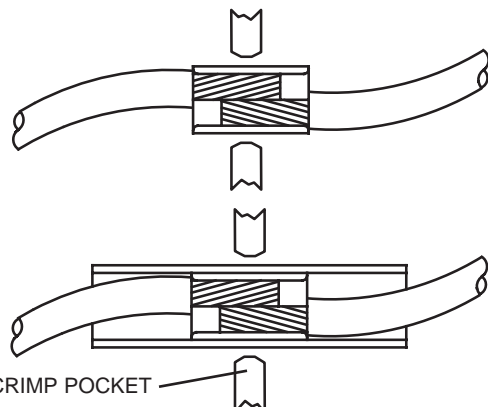

NON-INSULATED AND INSULATED PARALLEL SPLICE INSTRUCTIONS

1. Insert stripped wire into each end of the parallel splice. (See product packaging for proper strip lengths.)
2. Locate parallel splice in proper crimp pocket.
3. Position crimp pocket on the center of the metal barrel.
4. Squeeze handles firmly.

WIRE CUTTER for No. 10 AWG and smaller copper wire.

CRIMPING DIES for *PAN-TERM* insulated terminals, disconnects, splices and wire joints on No. 22 to 10 AWG stranded wire.

CUTTERS for machine screws of sizes shown, open handles, thread in this side. Closing handles cuts screw 0.15" below surface.

CRIMPING DIE for *PAN-TERM* non-insulated terminals, disconnects, splices and wire joints on No. 22 to 10 AWG solid or stranded wire.

CRIMP POCKETS A and B for additional terminals and disconnects per instructions on product packaging.

WIRE LOOP HOLES (2)

WIRE STRIPPER for removing plastic or rubber wire insulation. Strip length should allow a minimum of 1/32" of conductor to extend beyond terminal barrel.

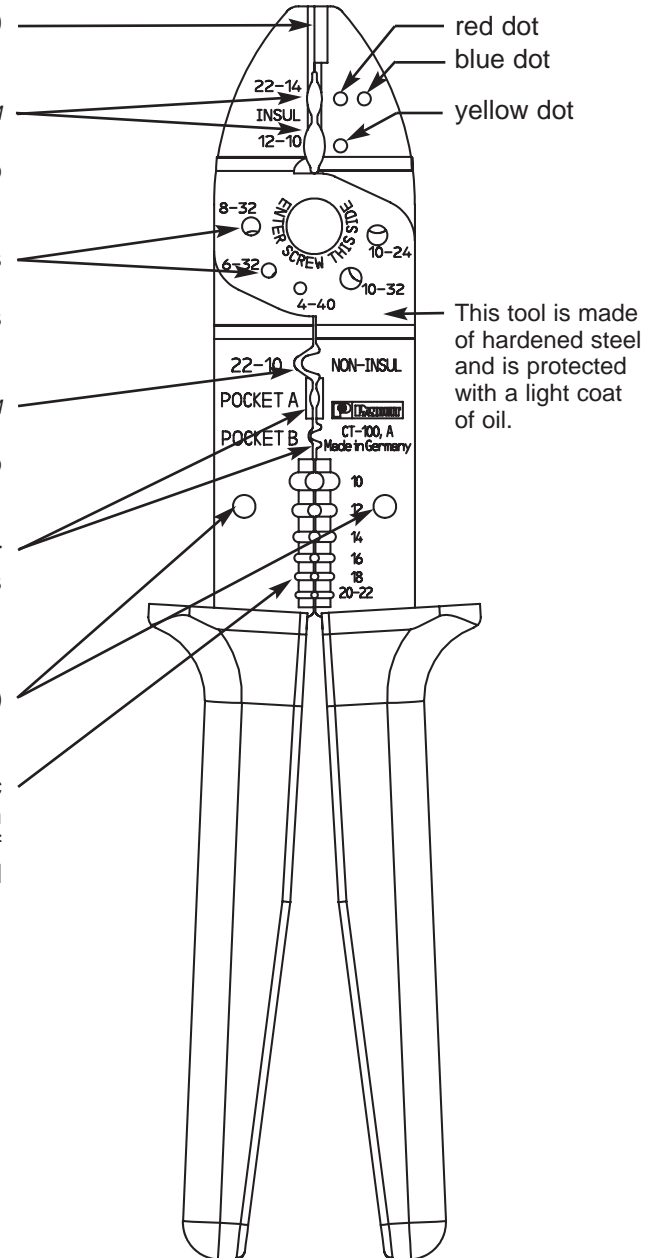

www.panduit.com
E-mail: cs@panduit.com



For Technical Support:
888-506-5400, ext. 3255
Fax: 630-759-7532

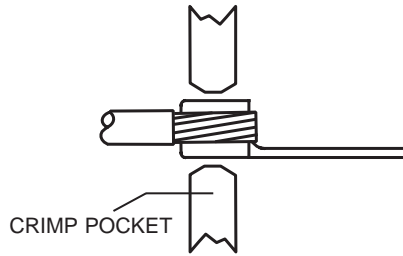

**NON-INSULATED
TERMINAL AND DISCONNECT
INSTRUCTIONS**

1. Insert stripped wire into terminal or disconnect until a minimum of 1/32" of conductor extends beyond barrel. (See product packaging for proper strip lengths.)
2. Locate terminal or disconnect in proper non-insulated crimp pocket.
3. Position crimp pocket on the center of the metal barrel.
4. Squeeze handles firmly.

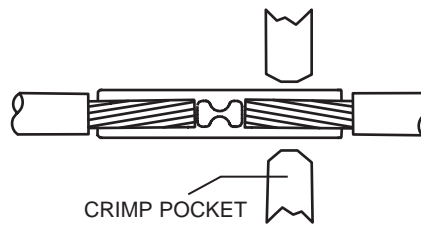

**NON-INSULATED BUTT SPLICE
INSTRUCTIONS**

1. Insert stripped wire into end of the butt splice to internal wire stop. (See product packaging for proper strip lengths.)
2. Locate butt splice in proper non-insulated crimp pocket.
3. Position crimp pocket on the center of the metal barrel half with wire inserted.
4. Squeeze handles firmly.
5. Repeat for other end of butt splice.

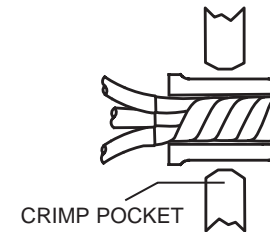

**NON-INSULATED WIRE JOINT
INSTRUCTIONS**

1. Twist ends of stripped wire together, trim and insert into wire joint. (See product packaging for proper strip lengths and trimming instructions.)
2. Locate wire joint in proper non-insulated crimp pocket.
3. Position crimp pocket on the center of the metal barrel.
4. Squeeze handles firmly.

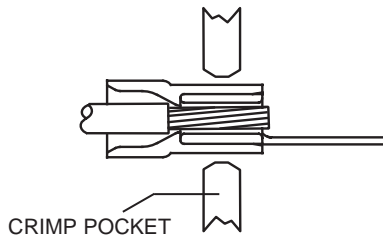

**INSULATED
TERMINAL AND DISCONNECT INSTRUCTIONS**

1. Insert stripped wire into terminal or disconnect until a minimum of 1/32" of conductor extends beyond barrel. (See product packaging for proper strip lengths.)
2. Locate terminal or disconnect in proper insulated crimp pocket.
3. Position crimp pocket on the center of the metal barrel.
4. Squeeze handles firmly.
5. Close insulation if desired.

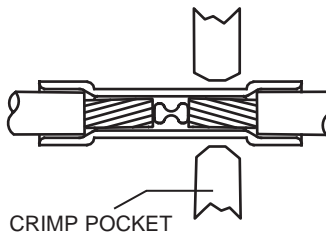

**INSULATED BUTT SPLICE
INSTRUCTIONS**

1. Insert stripped wire into end of the butt splice to internal wire stop. (See product packaging for proper strip lengths.)
2. Locate butt splice in proper insulated crimp pocket.
3. Position crimp pocket on the center of the metal barrel half with wire inserted.
4. Squeeze handles firmly.
5. Close insulation if desired.
6. Repeat for other end of butt splice.

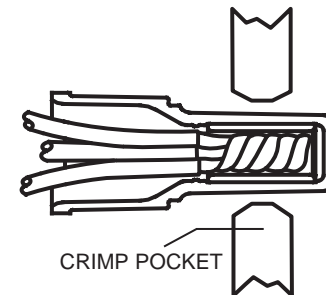

**INSULATED WIRE JOINT
INSTRUCTIONS**

1. Twist ends of stripped wire together, trim and insert into wire joint. (See product packaging for proper strip lengths and trimming instructions.)
2. Locate wire joint in proper insulated crimp pocket.
3. Position crimp pocket on the center of the metal barrel.
4. Squeeze handles firmly.
5. Close insulation if desired.