

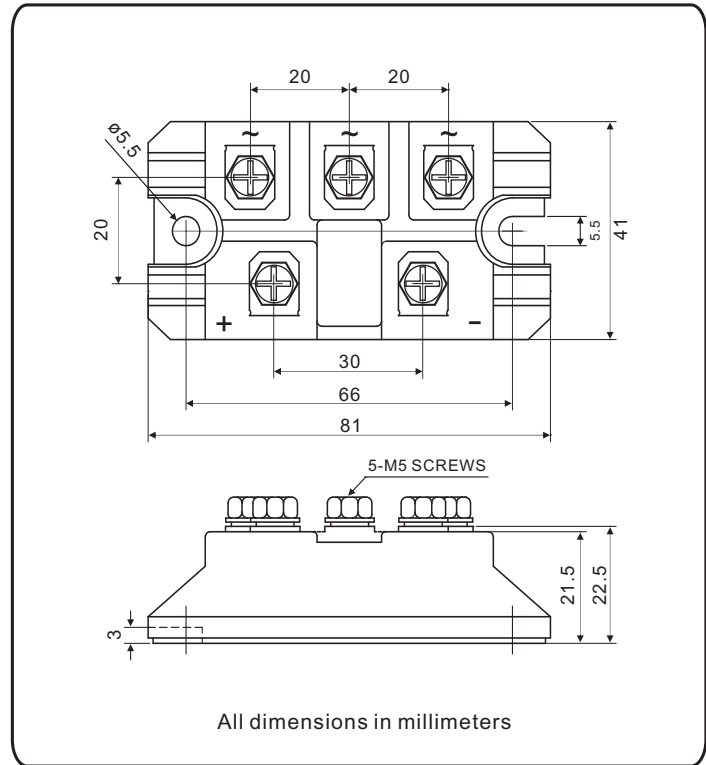

## Three-Phase Bridge Rectifier, 50A MTP5008A Thru MTP5016A



### FEATURES

- UL recognition file number E320098 
- Typical IR less than 2.0  $\mu$ A
- High surge current capability
- Low thermal resistance
- Compliant to RoHS 
- Isolation voltage up to 2500V

### TYPICAL APPLICATIONS

General purpose use in AC/DC bridge full wave rectification for big power supply, field supply for DC motor, industrial automation applications.

### ADVANTAGE

- International standard package  
Epoxy meets UL 94 V-O flammability rating
- Small volume, light weight
- Small thermal resistance
- **Weight:** 195g (6.9 ozs)

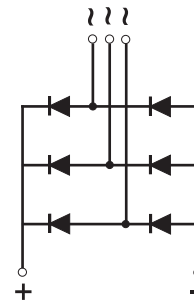

PRIMARY CHARACTERISTICS	
$I_{F(AV)}$	50A
$V_{RRM}$	800V to 1800V
$I_{FSM}$	750A
$I_R$	5 $\mu$ A
$V_F$	1.2V
$T_{Jmax.}$	150°C

## Nell High Power Products

MAJOR RATINGS AND CHARACTERISTICS ( $T_A = 25^\circ\text{C}$ unless otherwise noted)							
PARAMETER	SYMBOL	MTP50..A					UNIT
		08	10	12	16	18	
Maximum repetitive peak reverse voltage	$V_{RRM}$	800	1000	1200	1600	1800	V
Peak reverse non-repetitive voltage	$V_{RSM}$	900	1100	1300	1700	1900	V
Maximum DC blocking voltage	$V_{DC}$	800	1000	1200	1600	1800	V
Maximum average forward rectified output current	$I_{F(AV)}$	50					A
Peak forward surge current single sine-wave superimposed on rated load	$I_{FSM}$	750					A
Rating (non-repetitive, for t greater than 1 ms and less than 8.3 ms) for fusing	$I^2t$	2800					A <sup>2</sup> s
RMS isolation voltage from case to leads	$V_{ISO}$	2500					V
Operating junction storage temperature range	$T_J$	-40 to 150					°C
Storage temperature range	$T_{STG}$	-40 to 125					°C

ELECTRICAL CHARACTERISTICS ( $T_A = 25^\circ\text{C}$ unless otherwise noted)								
PARAMETER	TEST CONDITIONS	SYMBOL	MTP50..A					UNIT
			08	10	12	16	18	
Maximum instantaneous forward drop per diode	$I_F = 50\text{A}$	$V_F$	1.2					V
Maximum reverse DC current at rated DC blocking voltage per diode	$T_A = 25^\circ\text{C}$	$I_R$	20					$\mu\text{A}$
	$T_A = 150^\circ\text{C}$		4000					

THERMAL AND MECHANICAC ( $T_A = 25^\circ\text{C}$ unless otherwise noted)								
PARAMETER	TEST CONDITIONS	SYMBOL	MTP50..A					UNIT
			08	10	12	16	18	
Typical thermal resistance junction to case	Single-side heat dissipation, sine half wave	$R_{\theta JC}^{(1)}$	0.3					°C/W
Mounting torque $\pm 10\%$ to heatsink, M5 to heatsink, M5	A mounting compound is recommended and the torque should be rechecked after a period of 3 hours to allow for the spread of the compound.		4					Nm
			4					
Approximate weight			195					g

### Notes

- (1) With heatsink, single side heat dissipation, half sine wave.
- (2) M5 screw.

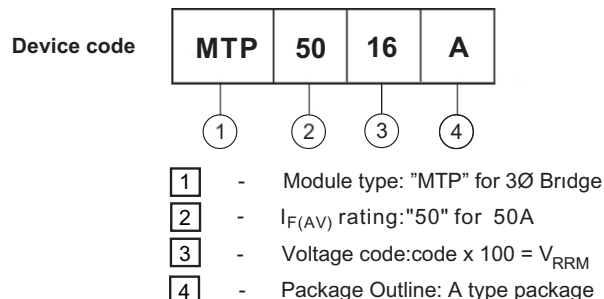

**Fig.1 Forward characteristic**

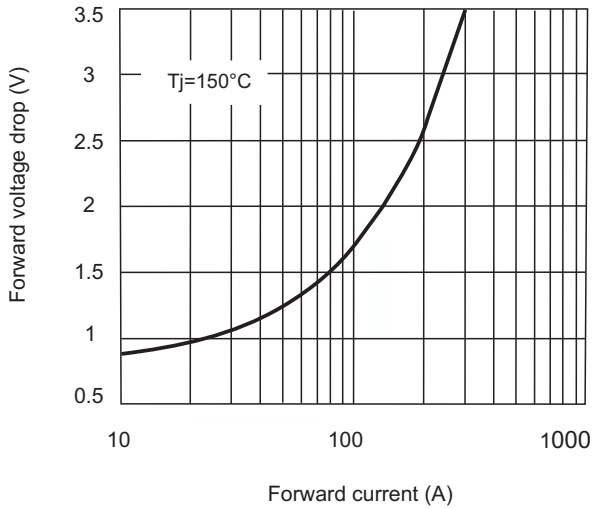

**Fig.2 Thermal Impedance (junction to case)**

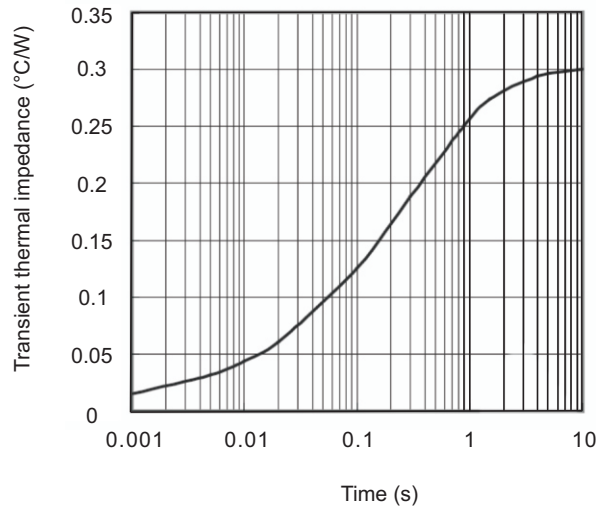

**Fig.3 Power dissipation vs. output current**

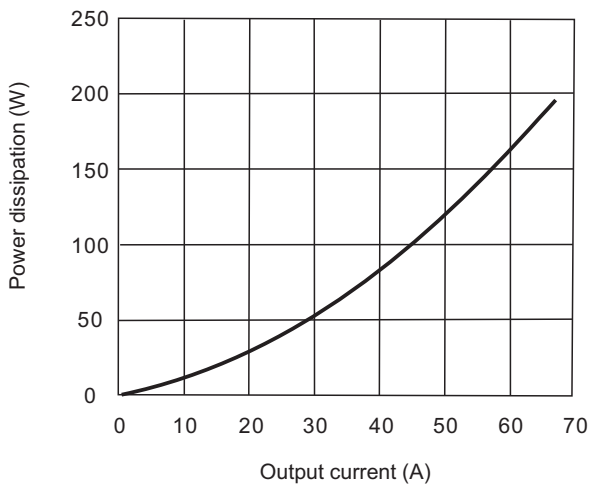

**Fig.4 Case temperature vs output current**

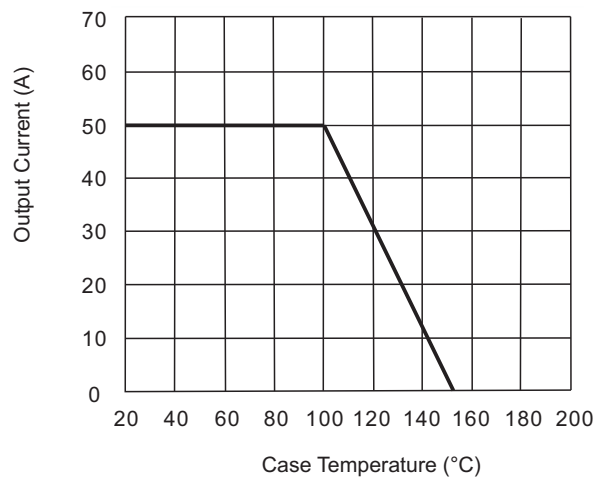

**Fig.5 Forward surge current vs. cycle**

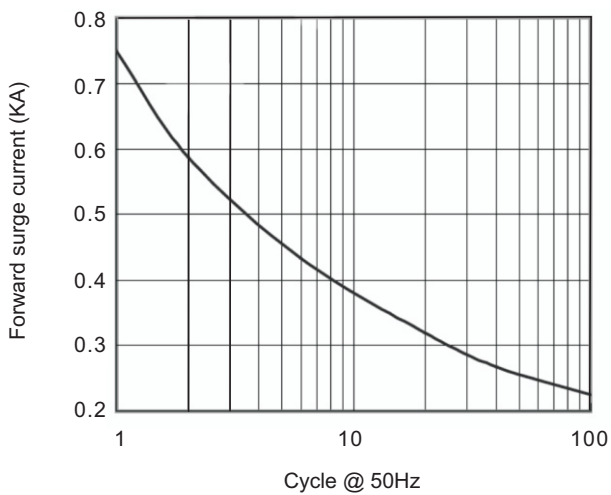

**Fig.6 I<sup>2</sup>t characteristic**

