

**RADIATION HARDENED
 POWER MOSFET
 SURFACE MOUNT(SMD-1)**

**IRHN7250
 JANSR2N7269U
 200V, N-CHANNEL
 REF:MIL-PRF-19500/603
 RAD-Hard™ HEXFET® TECHNOLOGY**

Product Summary

| Part Number | Radiation Level | RDS(on) | Id | QPL Part Number |
|-------------|-----------------|---------|-----|-----------------|
| IRHN7250 | 100K Rads (Si) | 0.1Ω | 26A | JANSR2N7269U |
| IRHN3250 | 300K Rads (Si) | 0.1Ω | 26A | JANSF2N7269U |
| IRHN4250 | 600K Rads (Si) | 0.1Ω | 26A | JANSG2N7269U |
| IRHN8250 | 1000K Rads (Si) | 0.1Ω | 26A | JANSH2N7269U |

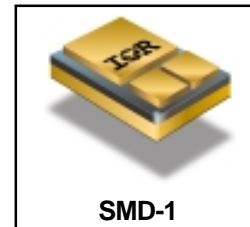

International Rectifier's RADHard HEXFET® technology provides high performance power MOSFETs for space applications. This technology has over a decade of proven performance and reliability in satellite applications. These devices have been characterized for both Total Dose and Single Event Effects (SEE). The combination of low Rds(on) and low gate charge reduces the power losses in switching applications such as DC to DC converters and motor control. These devices retain all of the well established advantages of MOSFETs such as voltage control, fast switching, ease of paralleling and temperature stability of electrical parameters.

Features:

- Single Event Effect (SEE) Hardened
- Low RDS(on)
- Low Total Gate Charge
- Proton Tolerant
- Simple Drive Requirements
- Ease of Paralleling
- Hermetically Sealed
- Surface Mount
- Ceramic Package
- Light Weight

Absolute Maximum Ratings

Pre-Irradiation

| | Parameter | | Units |
|----------------------------|--------------------------------------|----------------|-------|
| Id @ VGS = 12V, TC = 25°C | Continuous Drain Current | 26 | A |
| Id @ VGS = 12V, TC = 100°C | Continuous Drain Current | 16 | |
| IdM | Pulsed Drain Current ① | 104 | |
| PD @ TC = 25°C | Max. Power Dissipation | 150 | W |
| | Linear Derating Factor | 1.2 | W/°C |
| VGS | Gate-to-Source Voltage | ±20 | V |
| EAS | Single Pulse Avalanche Energy ② | 500 | mJ |
| IAR | Avalanche Current ① | 26 | A |
| EAR | Repetitive Avalanche Energy ① | 15 | mJ |
| dv/dt | Peak Diode Recovery dv/dt ③ | 5.0 | V/ns |
| TJ | Operating Junction | -55 to 150 | °C |
| TSTG | Storage Temperature Range | | |
| | Package Mounting Surface Temperature | 300 for 5 sec) | |
| | Weight | 2.6 (Typical) | g |

For footnotes refer to the last page

Electrical Characteristics @ T_j = 25°C (Unless Otherwise Specified)

| | Parameter | Min | Typ | Max | Units | Test Conditions |
|-------------------------------------|--|-----|------|------|-------|---|
| BV _{DSS} | Drain-to-Source Breakdown Voltage | 200 | — | — | V | V _{GS} = 0V, I _D = 1.0mA |
| ΔBV _{DSS} /ΔT _J | Temperature Coefficient of Breakdown Voltage | — | 0.27 | — | V/°C | Reference to 25°C, I _D = 1.0mA |
| R _{DSON} | Static Drain-to-Source On-State Resistance | — | — | 0.10 | Ω | V _{GS} = 12V, I _D = 16A ④ |
| | | — | — | 0.11 | | V _{GS} = 12V, I _D = 26A |
| V _{GS(th)} | Gate Threshold Voltage | 2.0 | — | 4.0 | V | V _{DS} = V _{GS} , I _D = 1.0mA |
| g _{fs} | Forward Transconductance | 8.0 | — | — | S (r) | V _{DS} > 15V, I _{DS} = 16A ④ |
| I _{DSS} | Zero Gate Voltage Drain Current | — | — | 25 | μA | V _{DS} = 160V, V _{GS} = 0V |
| | | — | — | 250 | | V _{DS} = 160V, V _{GS} = 0V, T _J = 125°C |
| I _{GSS} | Gate-to-Source Leakage Forward | — | — | 100 | nA | V _{GS} = 20V |
| I _{GSS} | Gate-to-Source Leakage Reverse | — | — | -100 | | V _{GS} = -20V |
| Q _g | Total Gate Charge | — | — | 170 | nC | V _{GS} = 12V, I _D = 26A |
| Q _{gs} | Gate-to-Source Charge | — | — | 30 | | V _{DS} = 100V |
| Q _{gd} | Gate-to-Drain ('Miller') Charge | — | — | 60 | | |
| t _{d(on)} | Turn-On Delay Time | — | — | 33 | ns | V _{DD} = 100V, I _D = 26A V _{GS} = 12V, R _G = 2.35Ω |
| t _r | Rise Time | — | — | 140 | | |
| t _{d(off)} | Turn-Off Delay Time | — | — | 140 | | |
| t _f | Fall Time | — | — | 140 | | |
| L _S + L _D | Total Inductance | — | 4.0 | — | nH | Measured from the center of drain pad to center of source pad |
| C _{iss} | Input Capacitance | — | 4700 | — | pF | V _{GS} = 0V, V _{DS} = 25V f = 1.0MHz |
| C _{oss} | Output Capacitance | — | 850 | — | | |
| C _{rss} | Reverse Transfer Capacitance | — | 210 | — | | |

Source-Drain Diode Ratings and Characteristics

| | Parameter | Min | Typ | Max | Units | Test Conditions |
|-----------------|--|--|-----|-----|-------|---|
| I _S | Continuous Source Current (Body Diode) | — | — | 26 | A | |
| I _{SM} | Pulse Source Current (Body Diode) ① | — | — | 104 | | |
| V _{SD} | Diode Forward Voltage | — | — | 1.4 | V | T _j = 25°C, I _S = 26A, V _{GS} = 0V ④ |
| t _{rr} | Reverse Recovery Time | — | — | 820 | nS | T _j = 25°C, I _F = 26A, di/dt ≤ 100A/μs |
| Q _{RR} | Reverse Recovery Charge | — | — | 12 | μC | V _{DD} ≤ 25V ④ |
| t _{on} | Forward Turn-On Time | Intrinsic turn-on time is negligible. Turn-on speed is substantially controlled by L _S + L _D . | | | | |

Thermal Resistance

| | Parameter | Min | Typ | Max | Units | Test Conditions |
|----------------------|----------------------|-----|-----|------|-------|---|
| R _{thJC} | Junction-to-Case | — | — | 0.83 | °C/W | Soldered to a 1 inch square clad PC board |
| R _{thJ-PCB} | Junction-to-PC board | — | 6.6 | — | | |

Note: Corresponding Spice and Saber models are available on the G&S Website.

For footnotes refer to the last page

Radiation Characteristics

IRHN7250

International Rectifier Radiation Hardened MOSFETs are tested to verify their radiation hardness capability. The hardness assurance program at International Rectifier is comprised of two radiation environments. Every manufacturing lot is tested for total ionizing dose (per notes 5 and 6) using the TO-3 package. Both pre- and post-irradiation performance are tested and specified using the same drive circuitry and test conditions in order to provide a direct comparison.

Table 1. Electrical Characteristics @ Tj = 25°C, Post Total Dose Irradiation ⑤⑥

| | Parameter | 100 KRads(Si) ¹ | | 300 - 1000K Rads (Si) ² | | Units | Test Conditions |
|---------------------|---|----------------------------|-------|------------------------------------|-------|-------|--|
| | | Min | Max | Min | Max | | |
| BV _{DSS} | Drain-to-Source Breakdown Voltage | 200 | — | 200 | — | V | V _{GS} = 0V, I _D = 1.0mA |
| V _{GS(th)} | Gate Threshold Voltage | 2.0 | 4.0 | 1.25 | 4.5 | | V _{GS} = V _{DS} , I _D = 1.0mA |
| I _{GSS} | Gate-to-Source Leakage Forward | — | 100 | — | 100 | nA | V _{GS} = 20V |
| I _{GSS} | Gate-to-Source Leakage Reverse | — | -100 | — | -100 | | V _{GS} = -20V |
| I _{DSS} | Zero Gate Voltage Drain Current | — | 25 | — | 50 | μA | V _{DS} =160V, V _{GS} =0V |
| R _{DS(on)} | Static Drain-to-Source ④ On-State Resistance (TO-3) | — | 0.100 | — | 0.155 | Ω | V _{GS} = 12V, I _D = 16A |
| R _{DS(on)} | Static Drain-to-Source ④ On-State Resistance (SMD-1) | — | 0.100 | — | 0.155 | Ω | V _{GS} = 12V, I _D = 16A |
| V _{SD} | Diode Forward Voltage ④ | — | 1.4 | — | 1.4 | V | V _{GS} = 0V, I _S = 26A |

1. Part number IRHN7250 (JANSR2N7269U)

2. Part numbers IRHN3250, IRHN4250 and IRHN8250 (JANSF2N7269U, JANSQ2N7269U and JANSJ2N7269U)

International Rectifier radiation hardened MOSFETs have been characterized in heavy ion environment for Single Event Effects (SEE). Single Event Effects characterization is illustrated in Fig. a and Table 2.

Table 2. Single Event Effect Safe Operating Area

| Ion | LET MeV/(mg/cm ²) | Energy (MeV) | Range (μm) | V _{DS} (V) | | | | |
|-----|----------------------------------|-----------------|---------------|----------------------|-----------------------|------------------------|------------------------|------------------------|
| | | | | @V _{GS} =0V | @V _{GS} =-5V | @V _{GS} =-10V | @V _{GS} =-15V | @V _{GS} =-20V |
| Cu | 28 | 285 | 43 | 190 | 180 | 170 | 125 | — |
| Br | 36.8 | 305 | 39 | 100 | 100 | 100 | 50 | — |

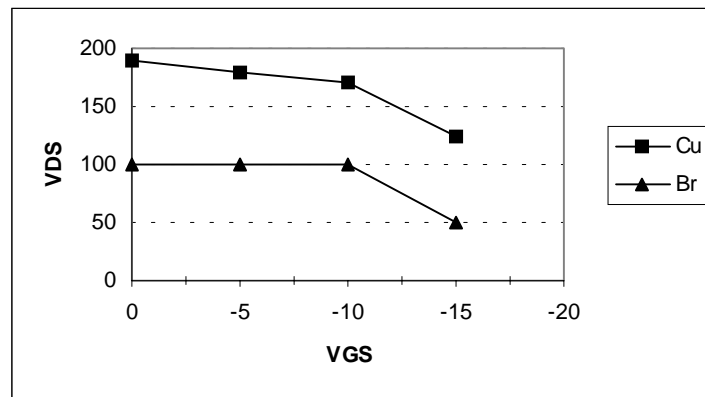

Fig a. Single Event Effect, Safe Operating Area

For footnotes refer to the last page

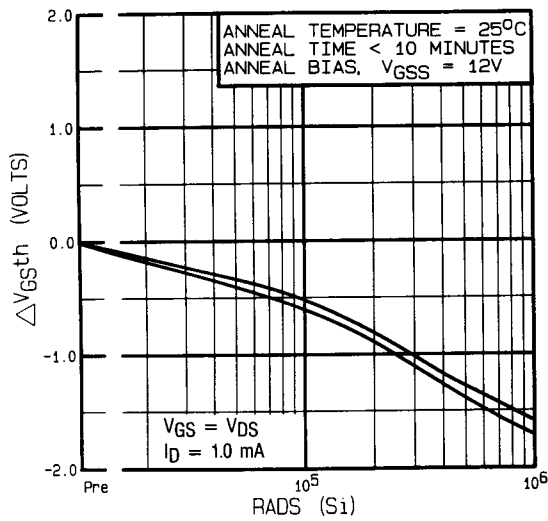

Fig 1. Typical Response of Gate Threshold Voltage Vs. Total Dose Exposure

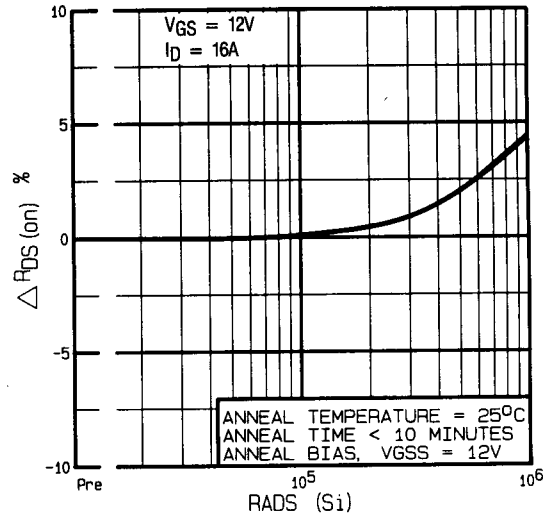

Fig 2. Typical Response of On-State Resistance Vs. Total Dose Exposure

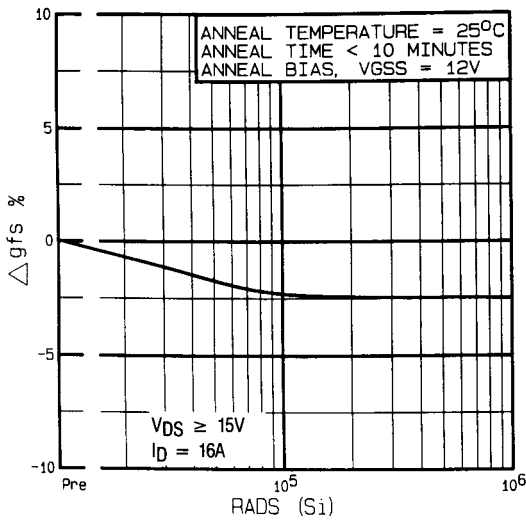

Fig 3. Typical Response of Transconductance Vs. Total Dose Exposure

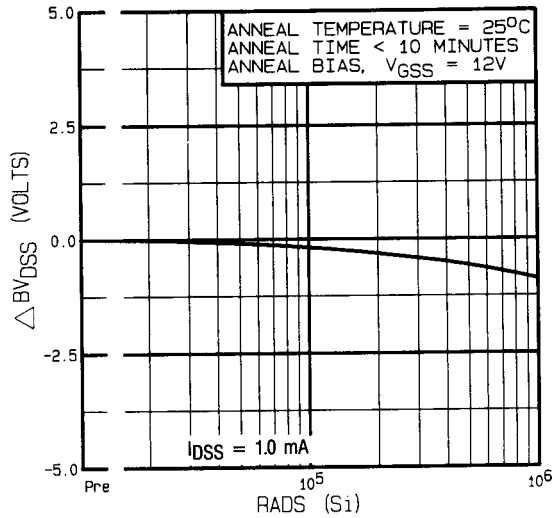

Fig 4. Typical Response of Drain to Source Breakdown Vs. Total Dose Exposure

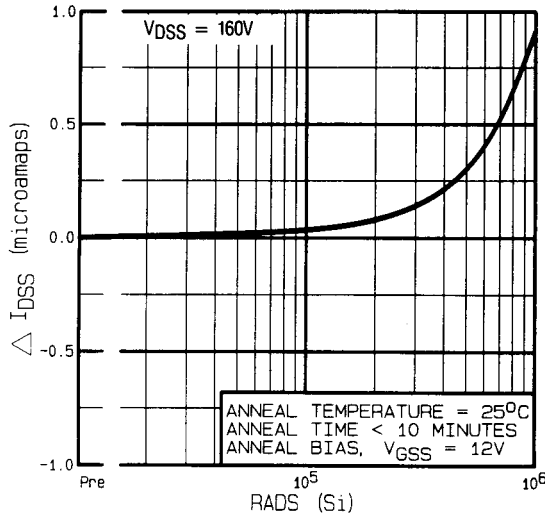

Fig 5. Typical Zero Gate Voltage Drain Current Vs. Total Dose Exposure

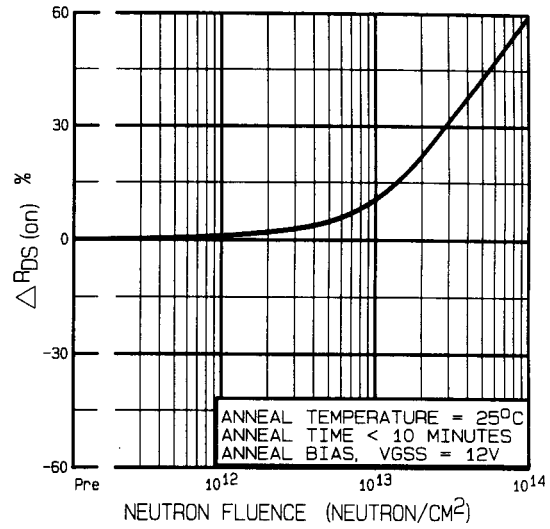

Fig 6. Typical On-State Resistance Vs. Neutron Fluence Level

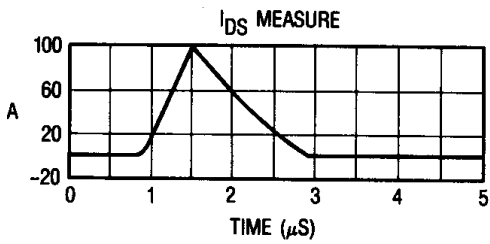
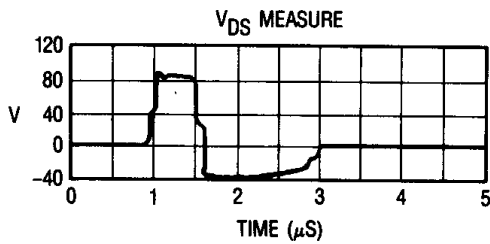

Fig 7. Typical Transient Response of Rad Hard HEXFET During 1×10^{12} Rad (Si)/Sec Exposure

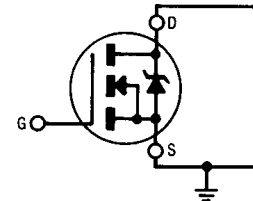

Fig 8a. Gate Stress of V_{GSS} Equals 12 Volts During Radiation

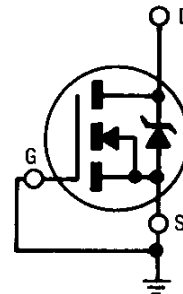

Fig 8b. V_{DSS} Stress Equals 80% of $B_{V_{DSS}}$ During Radiation

Note: Bias Conditions during radiation: $V_{GS} = 12\text{ Vdc}$, $V_{DS} = 0\text{ Vdc}$

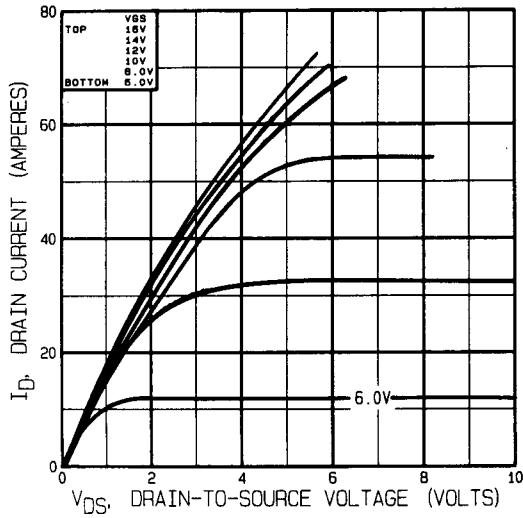

Fig 9. Typical Output Characteristics Pre-Irradiation

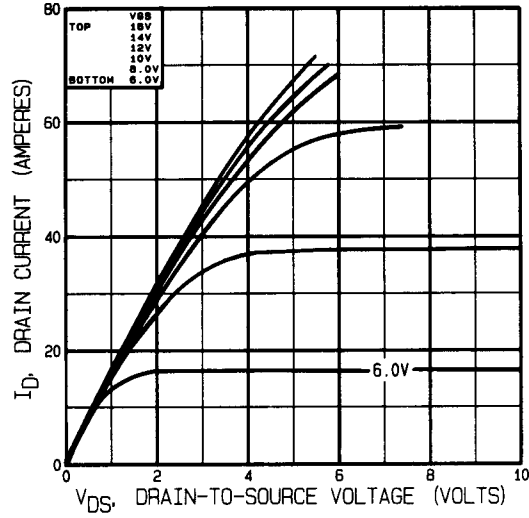

Fig 10. Typical Output Characteristics Post-Irradiation 100K Rads (Si)

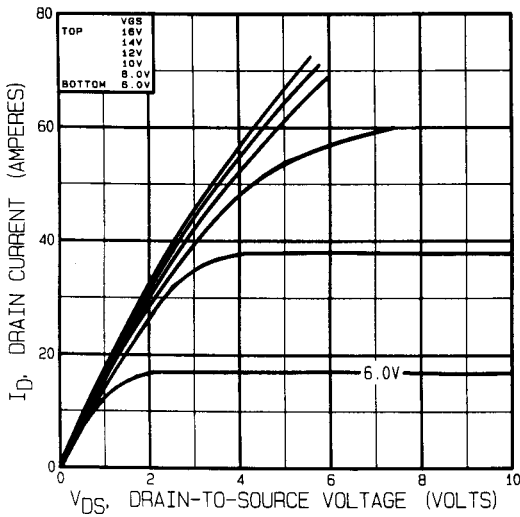

Fig 11. Typical Output Characteristics Post-Irradiation 300K Rads (Si)

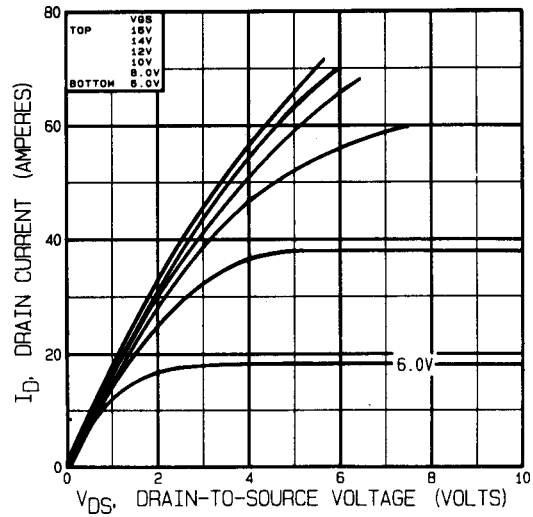

Fig 12. Typical Output Characteristics Post-Irradiation 1 Mega Rads (Si)

Note: Bias Conditions during radiation: $V_{GS} = 0$ Vdc, $V_{DS} = 160$ Vdc

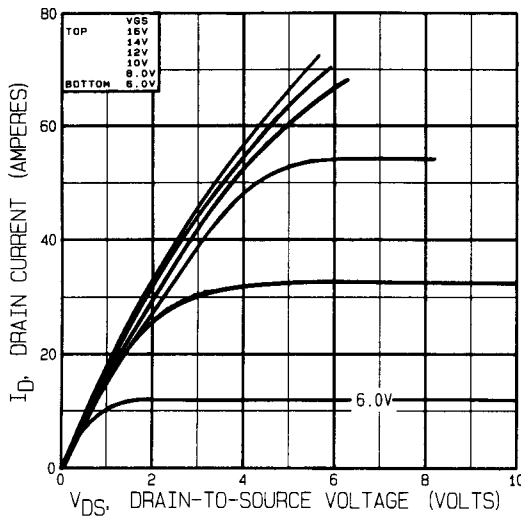

Fig 13. Typical Output Characteristics Pre-Irradiation

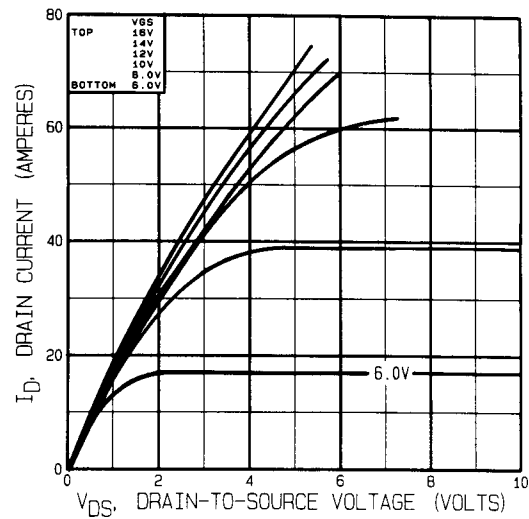

Fig 14. Typical Output Characteristics Post-Irradiation 100K Rads (Si)

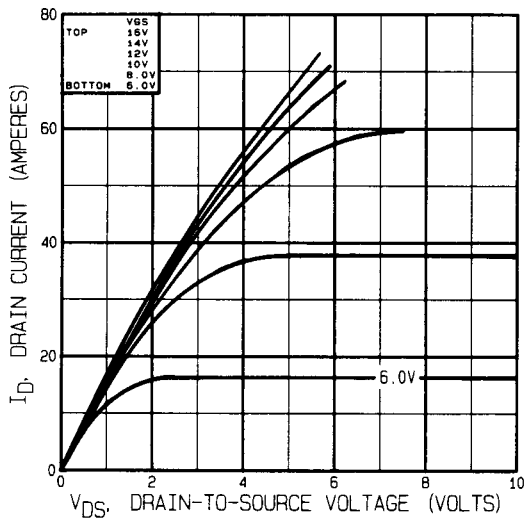

Fig 15. Typical Output Characteristics Post-Irradiation 300K Rads (Si)

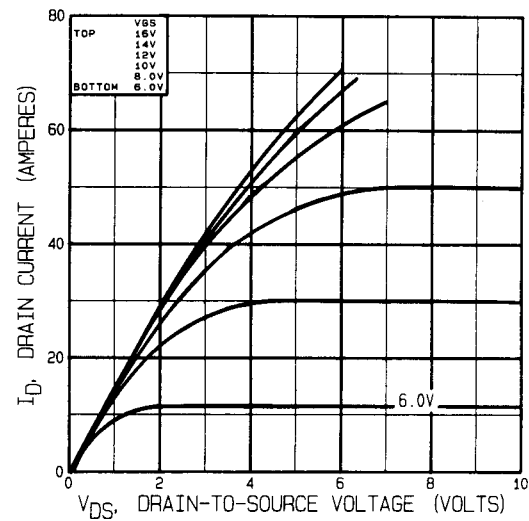

Fig 16. Typical Output Characteristics Post-Irradiation 1 Mega Rads (Si)

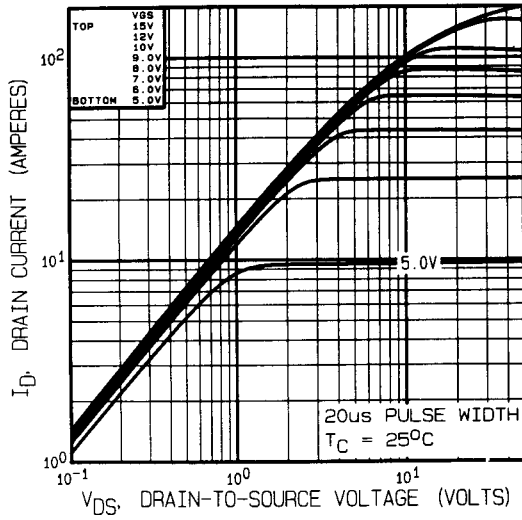

Fig 17. Typical Output Characteristics

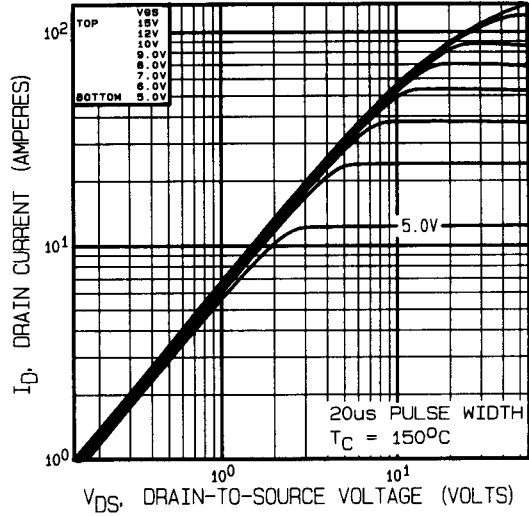

Fig 18. Typical Output Characteristics

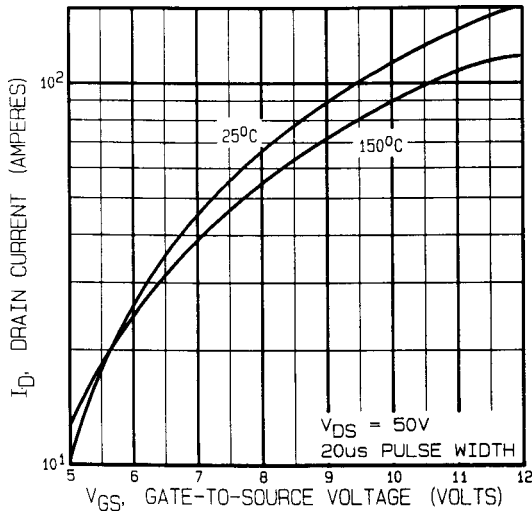

Fig 19. Typical Transfer Characteristics

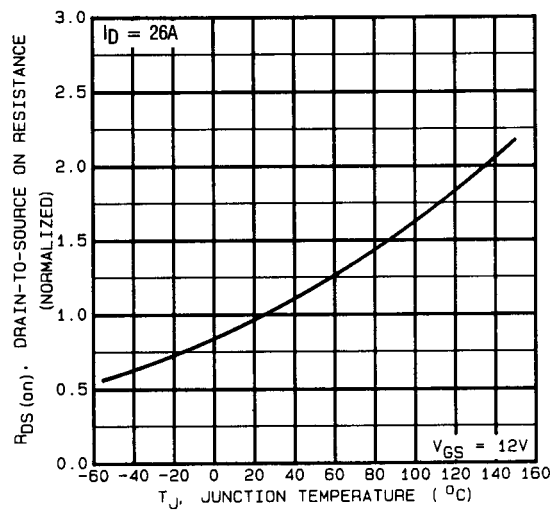

Fig 20. Normalized On-Resistance Vs. Temperature

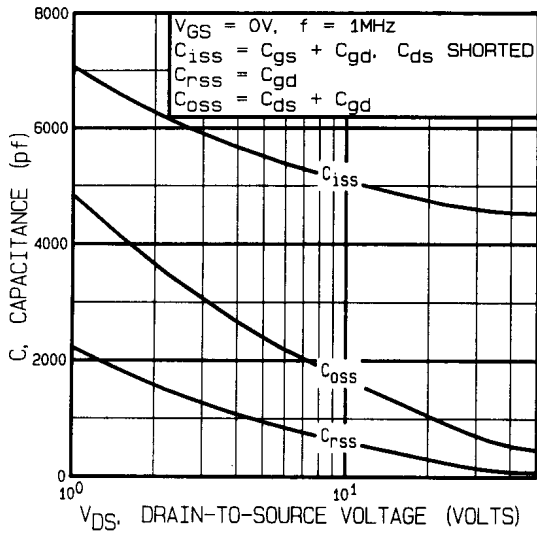

Fig 21. Typical Capacitance Vs. Drain-to-Source Voltage

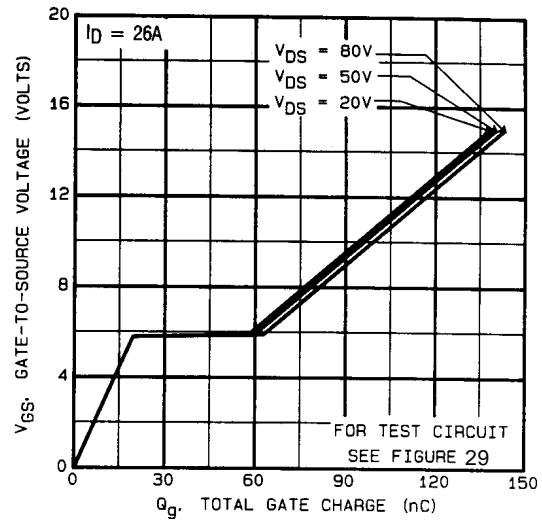

Fig 22. Typical Gate Charge Vs. Gate-to-Source Voltage

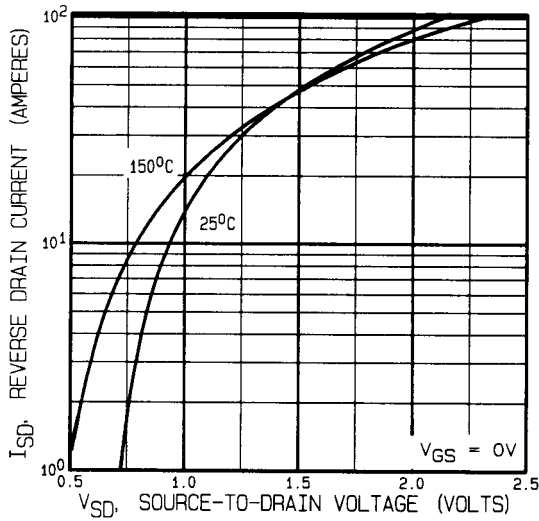

Fig 23. Typical Source-Drain Diode Forward Voltage

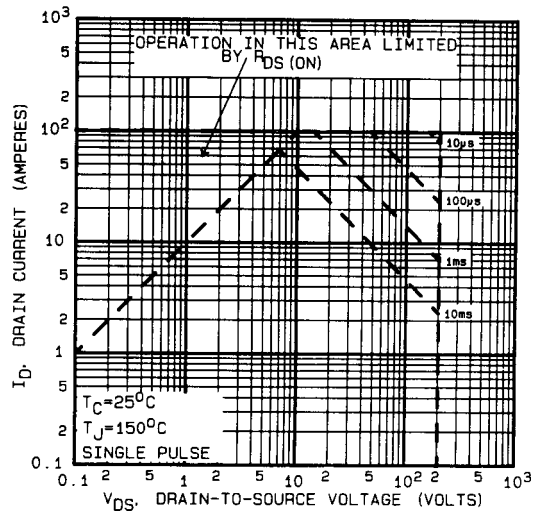

Fig 24. Maximum Safe Operating Area

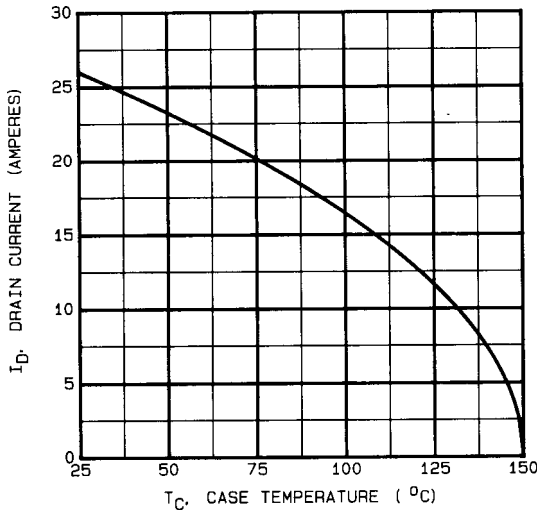

Fig 25. Maximum Drain Current Vs. Case Temperature

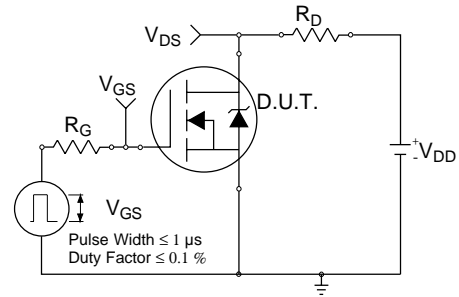

Fig 26a. Switching Time Test Circuit

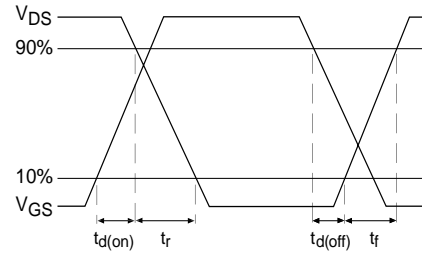

Fig 26b. Switching Time Waveforms

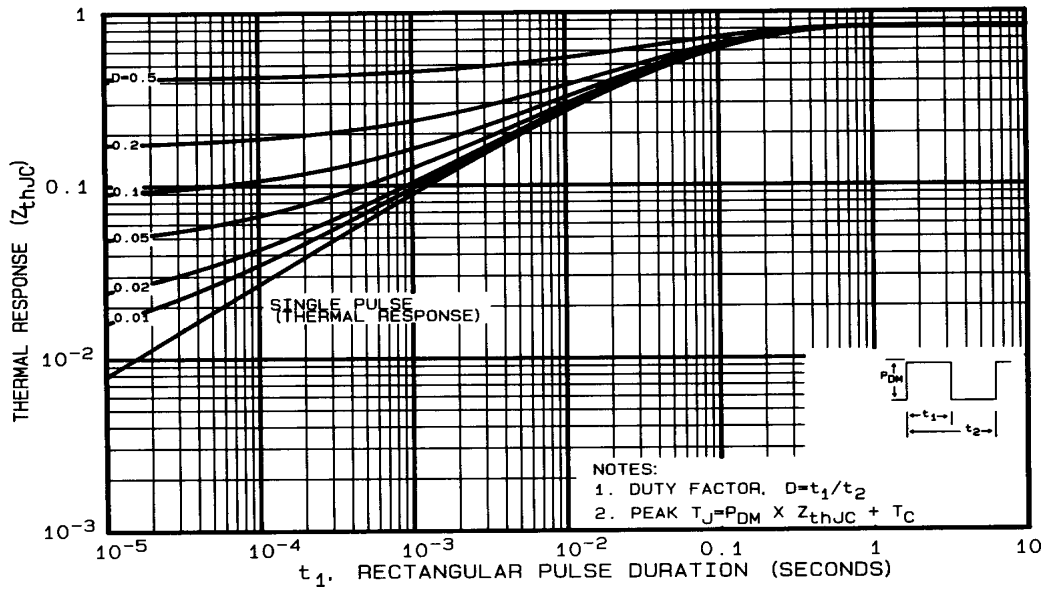

Fig 27. Maximum Effective Transient Thermal Impedance, Junction-to-Case

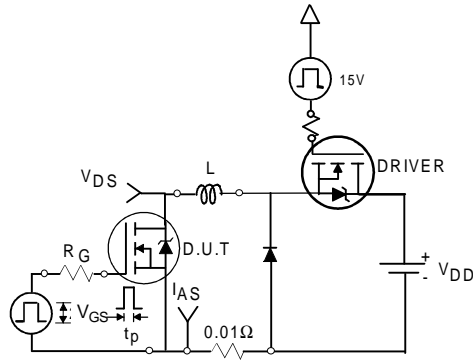

Fig 28a. Unclamped Inductive Test Circuit

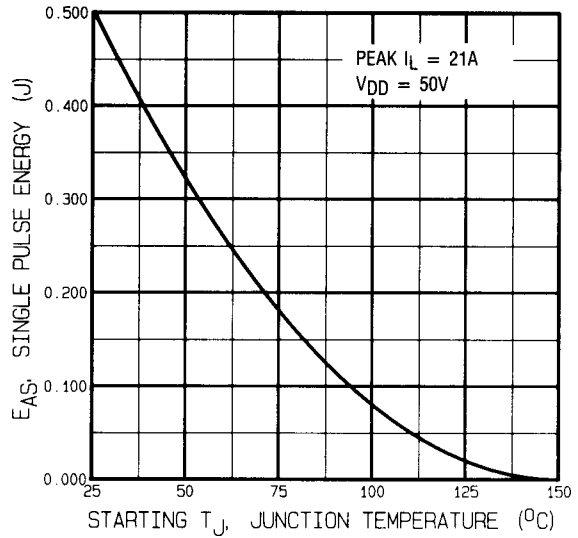

Fig 28c. Maximum Avalanche Energy Vs. Drain Current

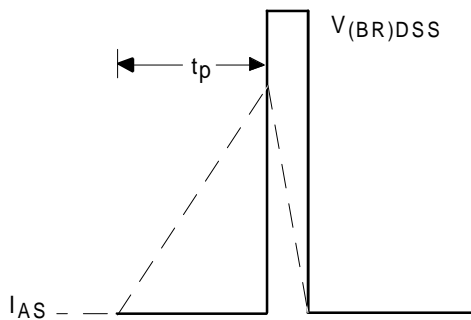

Fig 28b. Unclamped Inductive Waveforms

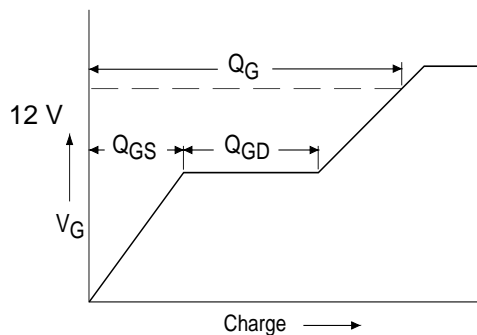

Fig 29a. Basic Gate Charge Waveform

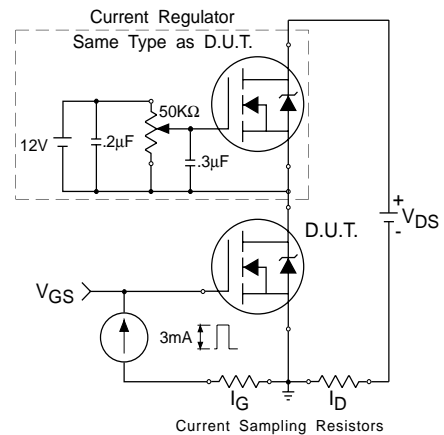
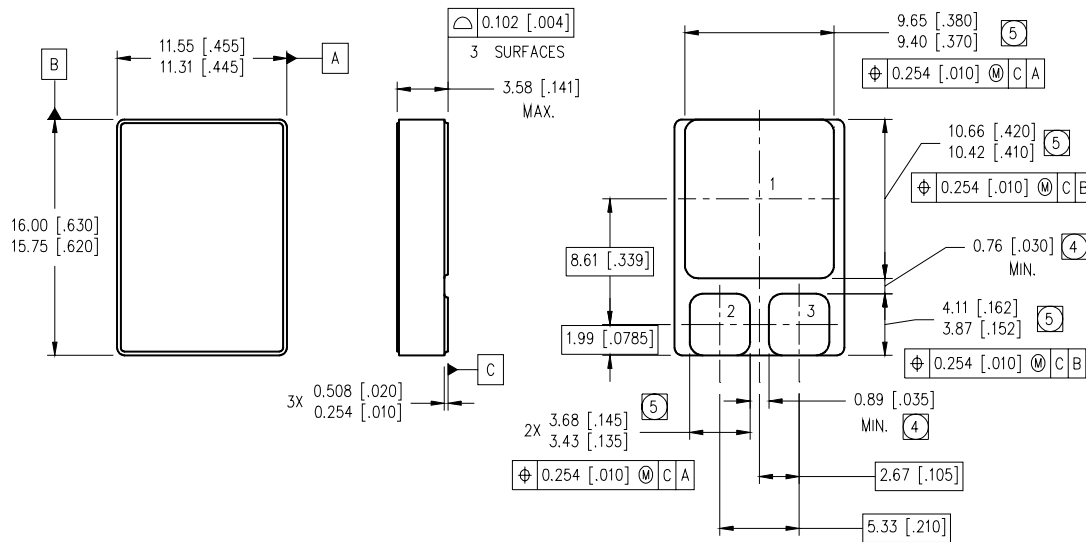

Fig 29b. Gate Charge Test Circuit

Foot Notes:

- ① Repetitive Rating; Pulse width limited by maximum junction temperature.
- ② $V_{DD} = 25V$, starting $T_J = 25^{\circ}C$, $L=1.48mH$
Peak $I_L = 26A$, $V_{GS} = 12V$
- ③ $I_{SD} \leq 26A$, $di/dt \leq 190A/\mu s$,
 $V_{DD} \leq 200V$, $T_J \leq 150^{\circ}C$
- ④ Pulse width $\leq 300 \mu s$; Duty Cycle $\leq 2\%$
- ⑤ **Total Dose Irradiation with V_{GS} Bias.**
12 volt V_{GS} applied and $V_{DS} = 0$ during irradiation per MIL-STD-750, method 1019, condition A.
- ⑥ **Total Dose Irradiation with V_{DS} Bias.**
160 volt V_{DS} applied and $V_{GS} = 0$ during irradiation per MIL-STD-750, method 1019, condition A.

Case Outline and Dimensions — SMD-1



NOTES:

- 1. DIMENSIONING & TOLERANCING PER ASME Y14.5M-1994.
- 2. CONTROLLING DIMENSION: INCH.
- 3. DIMENSIONS ARE SHOWN IN MILLIMETERS [INCHES].
- ④ DIMENSION INCLUDES METALLIZATION FLASH.
- ⑤ DIMENSION DOES NOT INCLUDE METALLIZATION FLASH.

PAD ASSIGNMENTS

- 1 = DRAIN
- 2 = GATE
- 3 = SOURCE



IR WORLD HEADQUARTERS: 233 Kansas St., El Segundo, California 90245, USA Tel: (310) 252-7105
TAC Fax: (310) 252-7903

Visit us at www.irf.com for sales contact information.
Data and specifications subject to change without notice. 12/01