

LED Lamps InGaN and Phosphor

TL21W01-L1(T34)

1. Applications

- General Lighting

2. Features

- (1) Size: 2.1 (L) mm × 2.5 (W) mm × 0.65 (H) mm
- (2) High luminous flux LED: 16 lm (typ.) @ $I_F = 60$ mA
- (3) Color: White (color temperature: 3000 K (typ.))
- (4) High Color Rendering Index : Ra = 85 (typ.)
- (5) Reflow-soldering is available.

3. Packaging and Internal Circuit

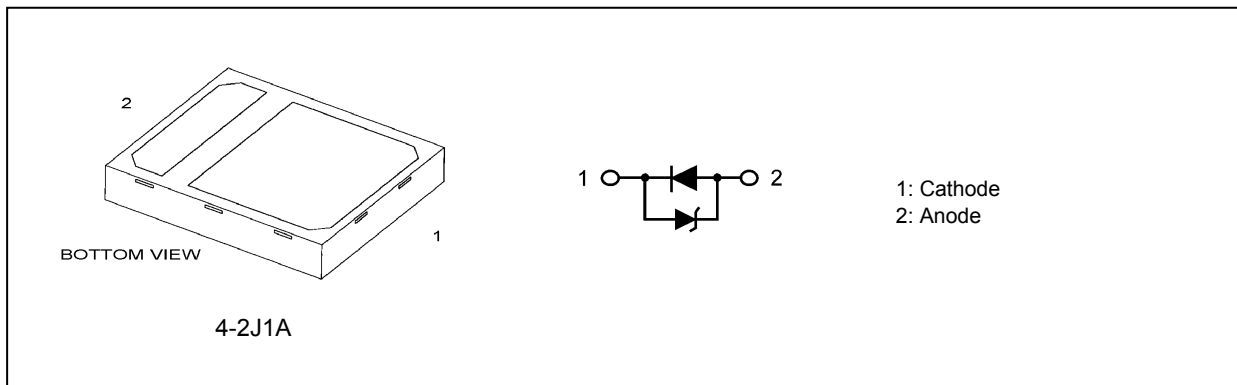

4. Absolute Maximum Ratings (Note) (Unless otherwise specified, $T_a = 25^\circ\text{C}$)

Characteristics	Symbol	Note	Rating	Unit
Forward current (DC)	I_F	See Fig. 4.1	100	mA
Forward current (pulsed)	I_{FP}	(Note 1)	180	
Power dissipation	P_D		0.39	W
Operating temperature	T_{opr}		-40 to 100	°C
Storage temperature	T_{stg}		-40 to 100	
Junction temperature	T_j		120	

Note: Using continuously under heavy loads (e.g. the application of high temperature/current/voltage and the significant change in temperature, etc.) may cause this product to decrease in the reliability significantly even if the operating conditions (i.e. operating temperature/current/voltage, etc.) are within the absolute maximum ratings.

Please design the appropriate reliability upon reviewing the Toshiba Semiconductor Reliability Handbook ("Handling Precautions"/"Derating Concept and Methods") and individual reliability data (i.e. reliability test report and estimated failure rate, etc).

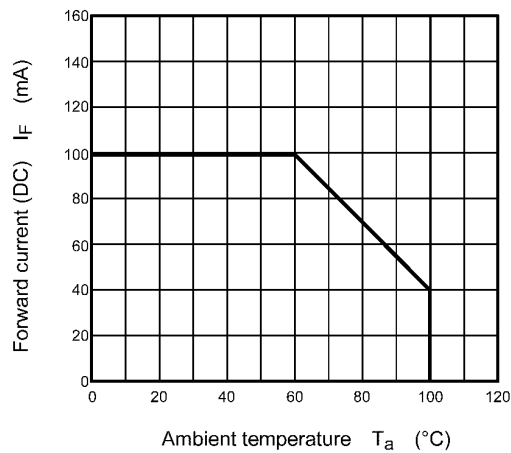

Fig. 4.1 $I_F - T_a$ (Note)

Note: The junction-to-ambient thermal resistance, $R_{th(j-a)}$, should be kept below 150°C/W so that this product is not exposed to a condition beyond the absolute maximum ratings.

$R_{th(j-a)}$: Thermal resistance from the LED junction to ambient temperature

Note 1: Pulse width 10 ms, duty = 1/10

5. Handling Precautions

- This product is sensitive to electrostatic and care must be fully taken when handling products. Particularly in the case that an overvoltage shall be applied, the overflowed energy may cause damage to or possibly result in destruction of the product. Users shall take absolutely secure countermeasures against electrostatic and surge when handling the product.
- Since this product is intended to be used for display lighting, the measurement standard is based on the spectral sensitivity of the human eye. It is not intended to be used for any applications other than display lighting (e.g., sensors and light communications systems.)
- Please note the handling of products during evaluation.
 1. Please do not apply pressure to the upper surface of the product with finger, tweezers, and others. Failure of product to light up may occur due to package deformation, wire deformation and/or disconnection.
 2. Should tweezers be used in product handling, one with flat surfaces is recommended.
 3. Please handle the product widthwise.
 4. Please do not drop the product. There is a possibility for package transformation etc. to occur when the product is dropped.
 5. Please do not stack the printed circuit boards on which the product is mounted to prevent damages to product surface. Also, please note not to damage the surface of the product with cushioning material etc. Surface damage to the product may influence their optical characteristics.

6. Electrical Characteristics (Unless otherwise specified, $T_a = 25^\circ\text{C}$)

Characteristics	Symbol	Note	Test Condition	Min	Typ.	Max	Unit
Forward voltage	V_F	See Table 6.1	$I_F = 60 \text{ mA}$	2.7	3.1	3.6	V
Reverse voltage	V_R		$I_R = 1 \text{ mA}$	—	0.75	—	
Thermal resistance (junction-to-soldering point)	$R_{th(j-s)}$	(Note 1)	$I_F = 60 \text{ mA}$	—	40	—	$^\circ\text{C/W}$

Note 1: $R_{th(j-s)}$: Thermal resistance from the LED junction to solder point.

Table 6.1 Forward Voltage (Note)

Rank	Test Condition	Forward Voltage (Min)	Forward Voltage (Max)	Unit
1	$I_F = 60 \text{ mA}$, $T_a = 25^\circ\text{C}$, Tolerance $\pm 0.1 \text{ V}$	2.7	3.0	V
2		3.0	3.3	
3		3.3	3.6	

Note: This LED lamp is sorted into forward voltage (V_F) ranks shown above. Each reel includes the same rank LEDs. Let the delivery ratio of each rank be unquestioned.

7. Optical Characteristics (Unless otherwise specified, $T_a = 25^\circ\text{C}$)

Characteristics	Symbol	Note	Test Condition	Min	Typ.	Max	Unit
Chromaticity	C_x	(Note 1)	$I_F = 60 \text{ mA}$	—	—	—	—
	C_y	(Note 1)	$I_F = 60 \text{ mA}$	—	—	—	
Luminous flux	ϕ_v	(Note 2)	$I_F = 60 \text{ mA}$	10.7	16	21.4	lm
Color temperature	CCT		$I_F = 60 \text{ mA}$	—	3000	—	K
Color rendering index	Ra	(Note 3)	$I_F = 60 \text{ mA}$	80	85	—	—

Note 1: See Fig. 7.1 and Table 7.1 for chromaticity rank.

Note 2: See Table 7.2 for luminous flux rank.

Note 3: Tolerance: ± 5

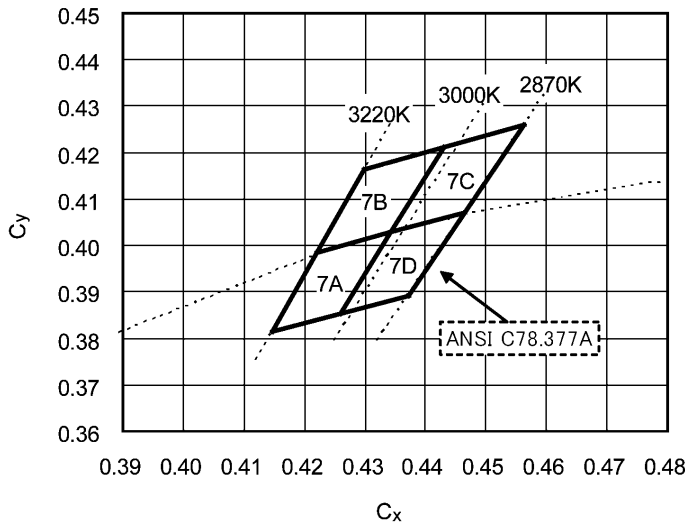

Fig. 7.1 Chromaticity Rank (Note)

Note: Test conditions: $I_F = 60 \text{ mA}$, $T_a = 25^\circ\text{C}$, Tolerance: ± 0.01

Table 7.1 Chromaticity Rank (Note)

	C_x	C_y		C_x	C_y
7A	0.4147	0.3814	7C	0.4342	0.4028
	0.4221	0.3984		0.4430	0.4212
	0.4342	0.4028		0.4562	0.4260
	0.4259	0.3853		0.4465	0.4071
7B	0.4221	0.3984	7D	0.4259	0.3853
	0.4299	0.4165		0.4342	0.4028
	0.4430	0.4212		0.4465	0.4071
	0.4342	0.4028		0.4373	0.3893

Note: This LED lamp is sorted into chromaticity coordinate groups shown above. Each reel includes the same rank LEDs. Let the delivery ratio of each rank be unquestioned.

Table 7.2 Luminous Flux Rank (Note)

Rank	Test Condition	Luminous Flux (Min)	Luminous Flux (Max)	Unit
C10	$I_F = 60 \text{ mA}$, $T_a = 25^\circ\text{C}$, Tolerance $\pm 10\%$	10.7	12.7	lm
C11		12.7	15.1	
C12		15.1	18.0	
C13		18.0	21.4	

Note: This LED lamp is sorted into luminous flux ranks shown above. Each reel includes the same rank LEDs. Let the delivery ratio of each rank be unquestioned.

Rank notations: The luminous flux, chromaticity and V_F ranks are printed on labels as shown below:

Example: 7A C12 2

7A: Chromaticity rank

C12: Luminous flux rank

2: V_F rank

8. Characteristics Curves (Note)

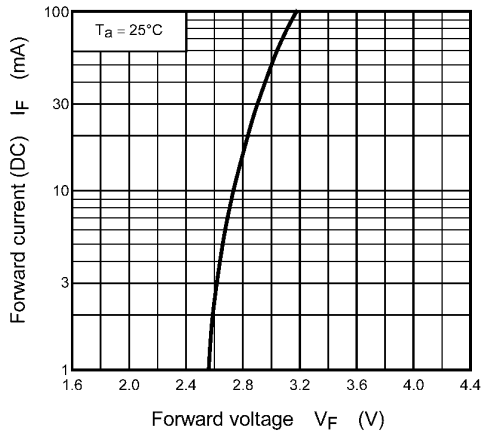

Fig. 8.1 $I_F - V_F$

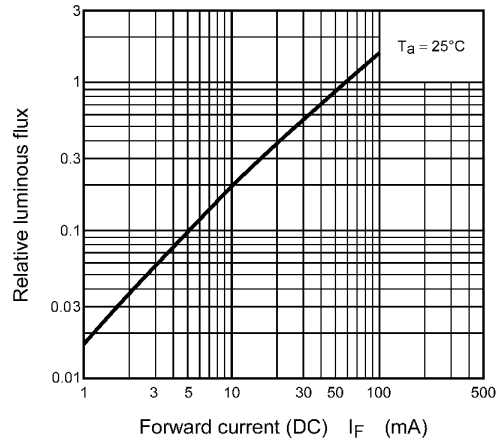

Fig. 8.2 Relative luminous flux - I_F

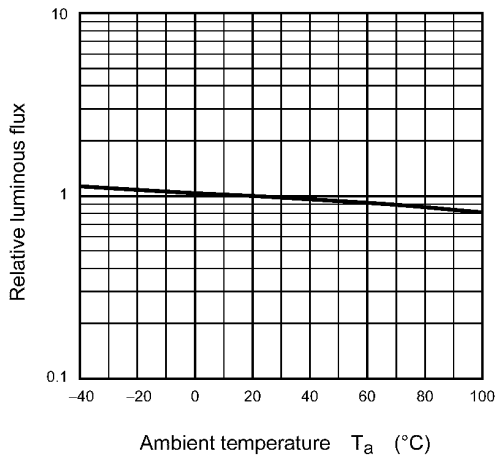

Fig. 8.3 Relative luminous flux - T_a

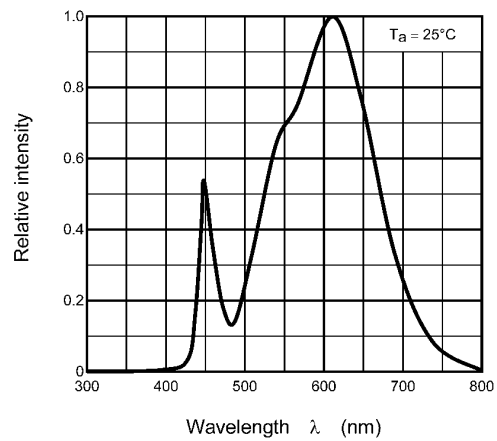

Fig. 8.4 Wavelength characteristic

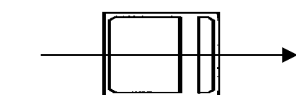
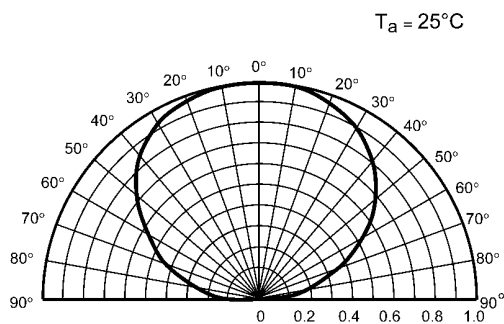

Fig. 8.5 Radiation Pattern

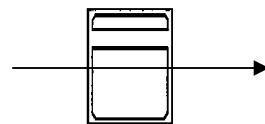
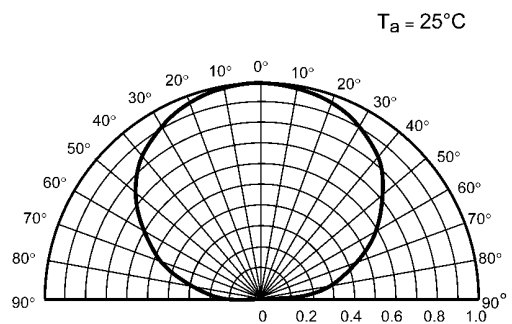

Fig. 8.6 Radiation pattern

Note: The above characteristics curves are presented for reference only and not guaranteed by production test, unless otherwise noted.

9. Packing

9.1. Moisture-Proof Packing

These LED devices are packed in an aluminum envelope with a silica gel and a moisture indicator to avoid moisture absorption. The optical characteristics of the device may be affected by exposure to moisture in the air before soldering and the device should therefore be stored under the following conditions:

- This moisture proof bag may be stored unopened within 12 months at the following conditions.
Temperature: 5°C to 30°C
Humidity: 90% (max)
- After opening the moisture proof bag, the device should be assembled within 168 hours in an environment of 5°C to 30°C/60% RH or below.
- If upon opening, the moisture indicator card shows humidity 30% or above (Color of indication changes to pink) or the expiration date has passed, the device should be baked in taping with reel.
After baking, use the baked device within 72 hours, but perform baking only once.
Baking conditions: 60±5°C, for 12 to 24 hours.
Expiration date: 12 months from sealing date, which is imprinted on the label affixed.
- Repeated baking can cause the peeling strength of the taping to change, then leads to trouble in mounting. Furthermore, prevent the devices from being destructed against static electricity for baking of it.
- If the packing material of laminate would be broken, the hermeticity would deteriorate. Therefore, do not throw or drop the packed devices.

10. Mounting

10.1. Mounting Precautions

- Do not apply mechanical stress to the resin body at high temperature.
The time taken for a device to return to the room temperature after reflow soldering depends on the mounting board and environmental conditions.
- The resin body is easily scratched. Avoid friction against hard materials.
- When installing an assembled board into equipment, ensure that the devices on the board do not contact with other components.

10.2. Soldering

Following show examples of reflow soldering.

- Temperature Profile (see following figures.)

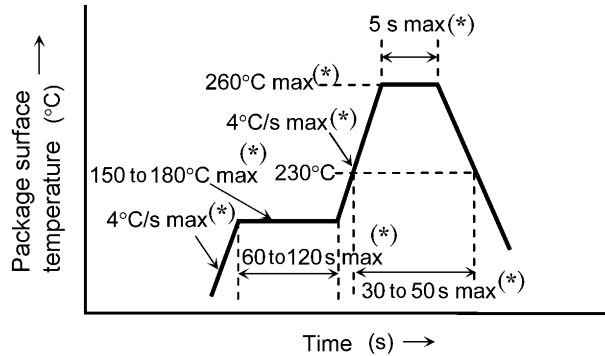
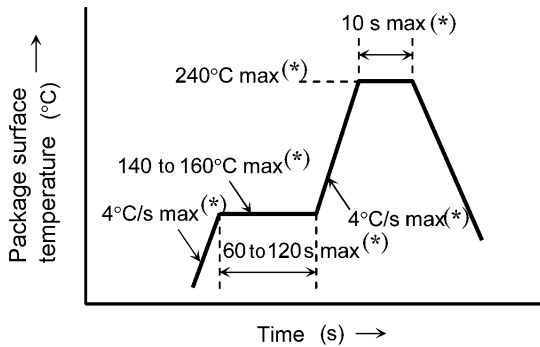

Fig. 10.2.1 Temperature Profile for Pb Soldering (example)

Fig. 10.2.2 Temperature profile for Lead(Pb)-free soldering (example)

- The product is evaluated using above reflow soldering conditions. No additional test is performed exceed the condition (i.e. the condition more than (*)MAX values) as a evaluation. Please perform reflow soldering under the above conditions.
- Please perform the first reflow soldering with reference to the above temperature profile and within 168 hours of opening the package.
- If a second reflow process is necessary, reflow soldering should be performed within 168 h of the first reflow under the above conditions. Storage conditions before the second reflow soldering: 30°C, 60% RH (max)
- Do not perform wave soldering.

10.3. Land Pattern Dimensions for Reference Only

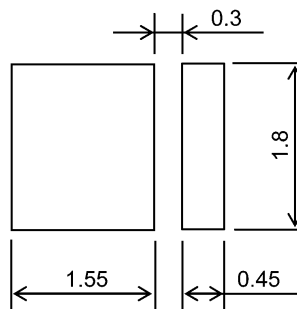

Fig. 10.3.1 Land Pattern Dimensions for Reference Only (Unit: mm)

11. Cleaning

When cleaning is required after soldering, Toshiba recommends the following cleaning solvents. It is confirmed that these solvents have no effect on semiconductor devices in our dipping test (under the recommended conditions). In selecting the one for your actual usage, please perform sufficient review on washing condition, using condition and etc.

Recommended cleaning solvents

ASAHI CLEAN AK-225AES: (made by ASAHI GLASS)

KAO CLEANTHROUGH 750HS: (made by KAO)

PINE ALPHA ST-100S: (made by ARAKAWA CHEMICAL)

12. Tape Specifications

12.1. Product Naming Conventions

The type of package used for shipment is denoted by a symbol suffix after the part number. The method of classification is as below. (this method, however does not apply to products whose electrical characteristics differ from standard Toshiba specifications)

Example: TL21W01-L1(T34

Toshiba part number: TL21W01-L1

Tape type: T34 (4·mm pitch)

12.2. Handling Precautions

- (1) The tape is antistatic-coated. However, if the tape is charged with excess static electricity, devices might cling to the tape or waggle in the tape when the cover tape peeled off. Be aware of the following to avoid this:

Use an ionizer to neutralize the ions when utilizing an automatic mounter.

For transport and temporary storage of devices, use containers (boxes, jigs, bags) that are made with antistatic materials or materials that dissipate static electricity.

12.3. Tape Dimensions

Table 12.3.1 Tape Dimensions (Unit: mm)

	D	E	P ₀	t	F	D ₁	P ₂	W	P	A ₀	B ₀	K ₀
Dimensions	1.5	1.75	4.0	0.2	3.5	1.1	2.0	8.0	4.0	2.38	2.78	0.8
Tolerance	+0.1/-0	±0.1	±0.1	±0.05	±0.05	±0.1	±0.05	±0.2	±0.1	±0.1	±0.1	±0.05

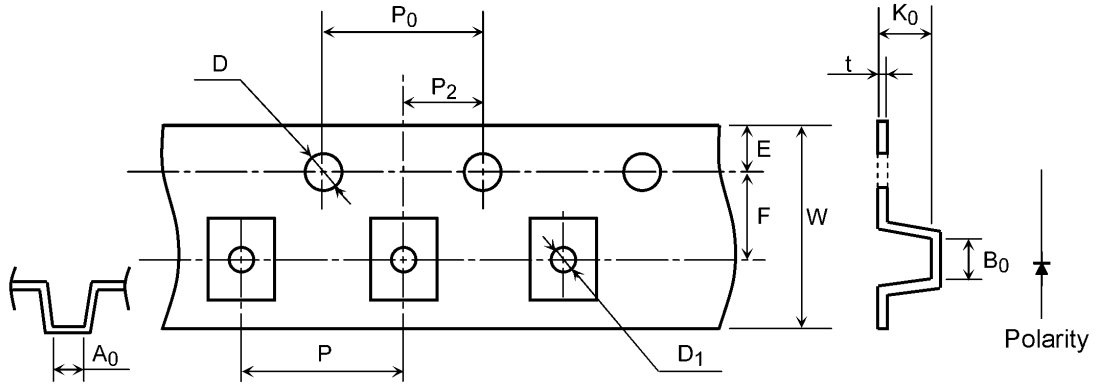

Fig. 12.3.1 Tape Dimensions

12.4. Reel Specification

12.4.1. Reel Dimensions

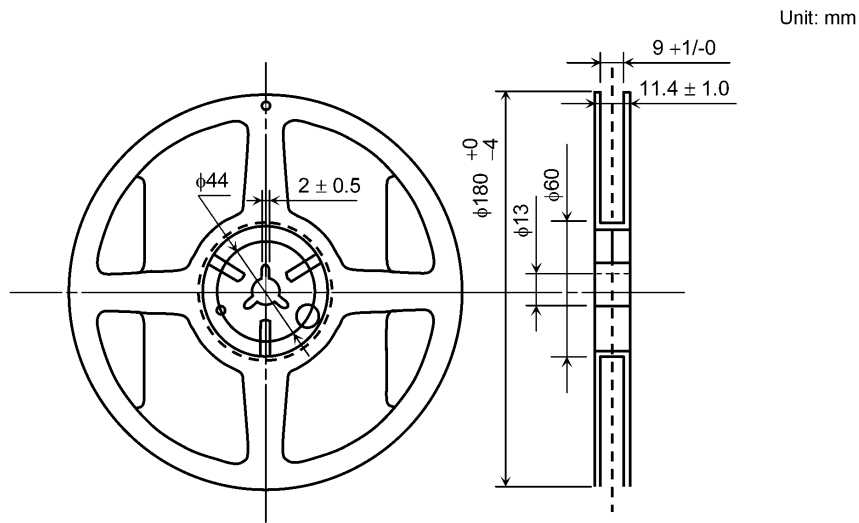

Fig. 12.4.1.1 Reel Dimensions

12.4.2. Tape Leader and Trailer

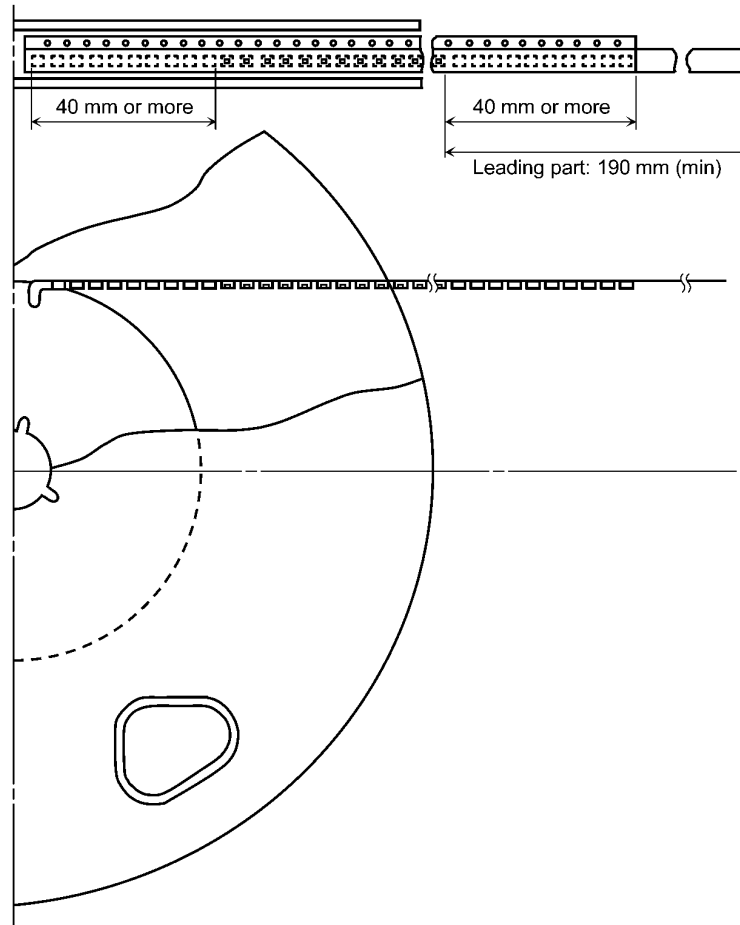

Fig. 12.4.2.1 Tape Leader and Trailer

12.5. Packing Form

Each reel is sealed in an aluminum pack with silica gel. Packing quantity is as shown below.

- Reel: 2,000 pcs
- Carton: 10,000 pcs
- Sealed aluminum pack with silica gel

12.6. Label Format

Label example for TL21W01-L1(T34 and label location are as shown below.

12.6.1. Label Example

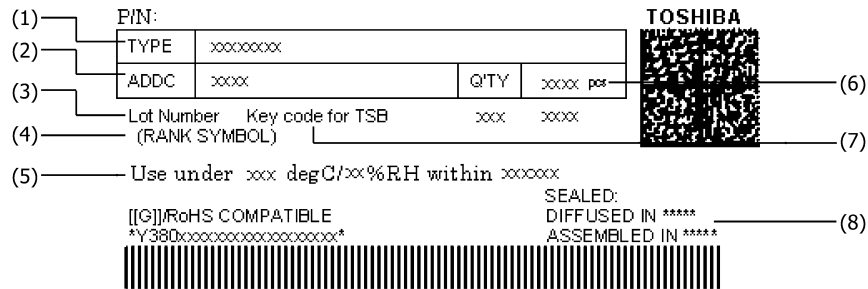

Fig. 12.6.1.1 Label Example

12.6.2. Label Details

No. (# refer to to the above label example)	Information for Customers Use	Information for Toshiba Use
(1)	Part No.	TL21W01-L1(T34
(2)	ADD code	Notation explanation (O Assembled in Japan, sales for domestic and overseas customers (J Assembled in overseas factory, sales for domestic customers (T Assembled in overseas factory, sales for overseas customers
(3)	Lot code	Example: 270xxxxx
(4)	Rank symbol	Example: 7AC122
(5)	Storage condition after Opening	Use under 5-30°C/60%RH within 168 h
(6)	Packing quantity	Example: 2,000 pcs
(7)	Key code	Example: 12345
(8)	Country of origin	Example: JAPAN

12.6.3. Label Location

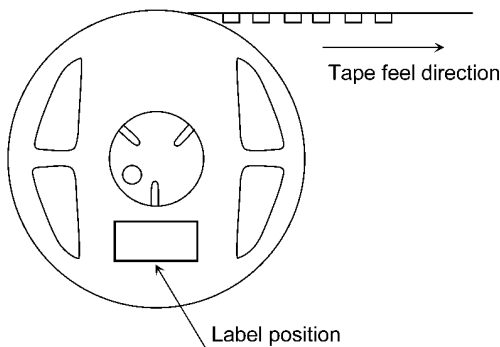

Fig. 12.6.3.1 Label Position on the Reel

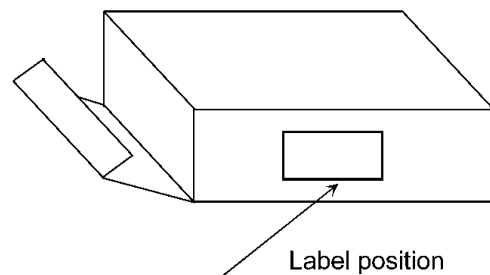
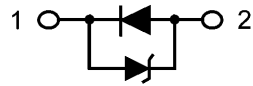

Fig. 12.6.3.2 Label Position on the Carton

Aluminum pack: The aluminum pack in which the reel is supplied also has the label attached to center of one side.

13. Internal Circuit



1: Cathode
2: Anode

Fig. 13.1 Internal Circuit

Package Dimensions

Unit: mm

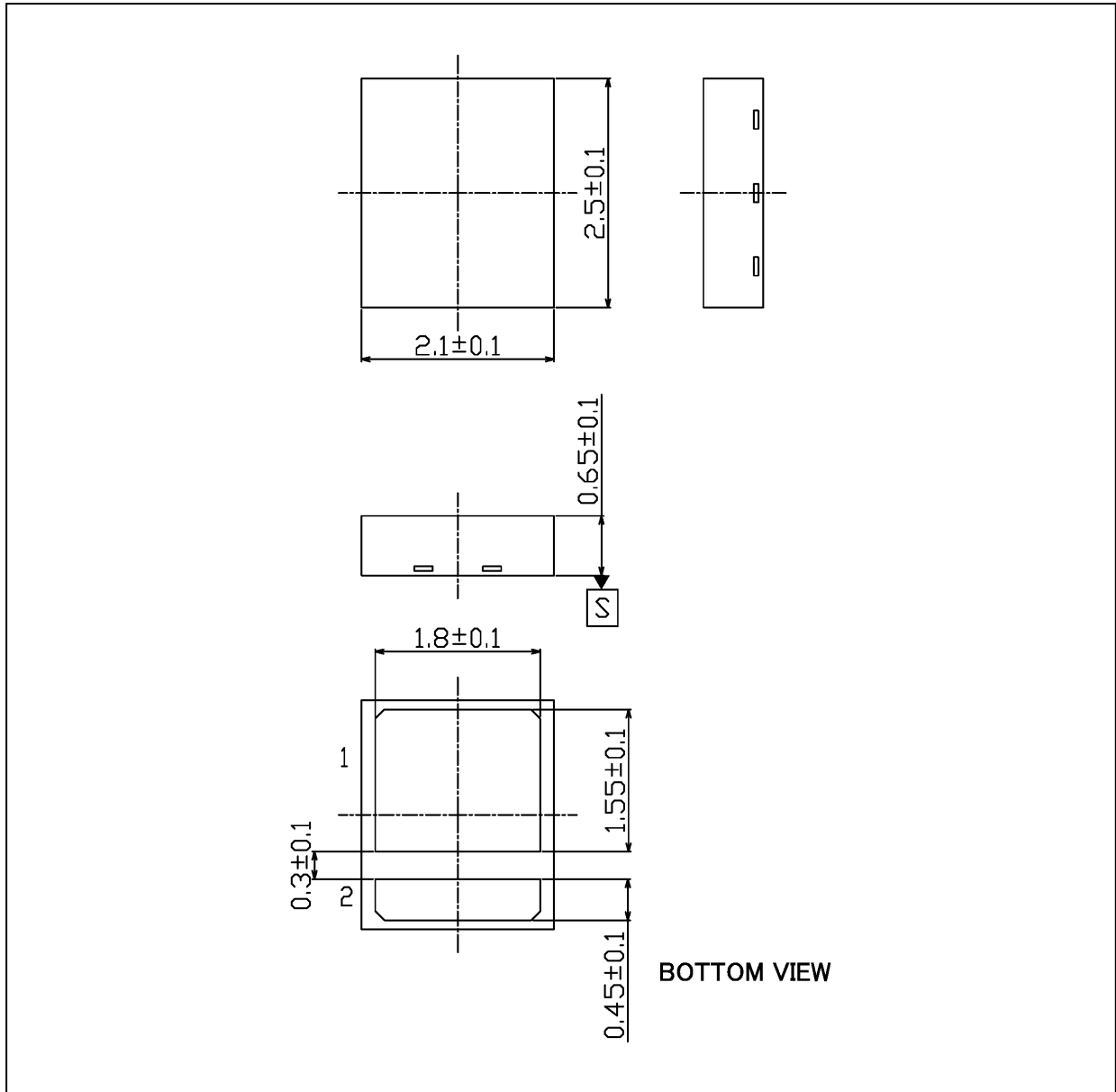

Weight: 0.007 g (typ.)

Package Name(s)
TOSHIBA: 4-2J1A

RESTRICTIONS ON PRODUCT USE

- Toshiba Corporation, and its subsidiaries and affiliates (collectively "TOSHIBA"), reserve the right to make changes to the information in this document, and related hardware, software and systems (collectively "Product") without notice.
- This document and any information herein may not be reproduced without prior written permission from TOSHIBA. Even with TOSHIBA's written permission, reproduction is permissible only if reproduction is without alteration/omission.
- Though TOSHIBA works continually to improve Product's quality and reliability, Product can malfunction or fail. Customers are responsible for complying with safety standards and for providing adequate designs and safeguards for their hardware, software and systems which minimize risk and avoid situations in which a malfunction or failure of Product could cause loss of human life, bodily injury or damage to property, including data loss or corruption. Before customers use the Product, create designs including the Product, or incorporate the Product into their own applications, customers must also refer to and comply with (a) the latest versions of all relevant TOSHIBA information, including without limitation, this document, the specifications, the data sheets and application notes for Product and the precautions and conditions set forth in the "TOSHIBA Semiconductor Reliability Handbook" and (b) the instructions for the application with which the Product will be used with or for. Customers are solely responsible for all aspects of their own product design or applications, including but not limited to (a) determining the appropriateness of the use of this Product in such design or applications; (b) evaluating and determining the applicability of any information contained in this document, or in charts, diagrams, programs, algorithms, sample application circuits, or any other referenced documents; and (c) validating all operating parameters for such designs and applications.
TOSHIBA ASSUMES NO LIABILITY FOR CUSTOMERS' PRODUCT DESIGN OR APPLICATIONS.
- Product is intended for use in general electronics applications (e.g., computers, personal equipment, office equipment, measuring equipment, industrial robots and home electronics appliances) or for specific applications as expressly stated in this document. Product is neither intended nor warranted for use in equipment or systems that require extraordinarily high levels of quality and/or reliability and/or a malfunction or failure of which may cause loss of human life, bodily injury, serious property damage or serious public impact ("Unintended Use"). Unintended Use includes, without limitation, equipment used in nuclear facilities, equipment used in the aerospace industry, medical equipment, equipment used for automobiles, trains, ships and other transportation, traffic signaling equipment, equipment used to control combustions or explosions, safety devices, elevators and escalators, devices related to electric power, and equipment used in finance-related fields. Do not use Product for Unintended Use unless specifically permitted in this document.
- Do not disassemble, analyze, reverse-engineer, alter, modify, translate or copy Product, whether in whole or in part.
- Product shall not be used for or incorporated into any products or systems whose manufacture, use, or sale is prohibited under any applicable laws or regulations.
- The information contained herein is presented only as guidance for Product use. No responsibility is assumed by TOSHIBA for any infringement of patents or any other intellectual property rights of third parties that may result from the use of Product. No license to any intellectual property right is granted by this document, whether express or implied, by estoppel or otherwise.
- **ABSENT A WRITTEN SIGNED AGREEMENT, EXCEPT AS PROVIDED IN THE RELEVANT TERMS AND CONDITIONS OF SALE FOR PRODUCT, AND TO THE MAXIMUM EXTENT ALLOWABLE BY LAW, TOSHIBA (1) ASSUMES NO LIABILITY WHATSOEVER, INCLUDING WITHOUT LIMITATION, INDIRECT, CONSEQUENTIAL, SPECIAL, OR INCIDENTAL DAMAGES OR LOSS, INCLUDING WITHOUT LIMITATION, LOSS OF PROFITS, LOSS OF OPPORTUNITIES, BUSINESS INTERRUPTION AND LOSS OF DATA, AND (2) DISCLAIMS ANY AND ALL EXPRESS OR IMPLIED WARRANTIES AND CONDITIONS RELATED TO SALE, USE OF PRODUCT, OR INFORMATION, INCLUDING WARRANTIES OR CONDITIONS OF MERCHANTABILITY, FITNESS FOR A PARTICULAR PURPOSE, ACCURACY OF INFORMATION, OR NONINFRINGEMENT.**
- Do not use or otherwise make available Product or related software or technology for any military purposes, including without limitation, for the design, development, use, stockpiling or manufacturing of nuclear, chemical, or biological weapons or missile technology products (mass destruction weapons). Product and related software and technology may be controlled under the Japanese Foreign Exchange and Foreign Trade Law and the U.S. Export Administration Regulations. Export and re-export of Product or related software or technology are strictly prohibited except in compliance with all applicable export laws and regulations.
- Please contact your TOSHIBA sales representative for details as to environmental matters such as the RoHS compatibility of Product. Please use Product in compliance with all applicable laws and regulations that regulate the inclusion or use of controlled substances, including without limitation, the EU RoHS Directive. TOSHIBA assumes no liability for damages or losses occurring as a result of noncompliance with applicable laws and regulations.