

PLEASE CHECK WWW.MOLEX.COM FOR LATEST PART INFORMATION

Part Number: [0679260021](#)
Status: **Active**
Description: 3.81mm (.150") Pitch Serial ATA IDT Power Receptacle, Gold (Au) Flash, 18AWG, with Latch, with Bump, Lead free

Documents:

[3D Model](#)
[Drawing \(PDF\)](#)

[RoHS Certificate of Compliance \(PDF\)](#)

General

Product Family	IDT and Solder Connectors
Series	67926
Crimp Quality Equipment	Yes
Product Name	Serial ATA
Use With	67926-0040 Feed-to Cover, 67926-0041 Feed-Through Cover

Physical

Circuits (Loaded)	5
Color - Resin	Black
Durability (mating cycles max)	50
Gender	Female
Glow-Wire Compliant	No
Lock to Mating Part	Yes
Material - Metal	Copper Alloy
Material - Plating Mating	Gold
Material - Plating Termination	Tin
Number of Rows	1
Packaging Type	Tray
Panel Mount	No
Pitch - Mating Interface (in)	0.150 In
Pitch - Mating Interface (mm)	3.81 mm
Pitch - Term. Interface (in)	0.150 In
Pitch - Term. Interface (mm)	3.81 mm
Plating min: Mating (µin)	2
Plating min: Mating (µm)	0.05
Plating min: Termination (µin)	75
Plating min: Termination (µm)	1.90
Polarized to Mating Part	Yes
Temperature Range - Operating	-35°C to +85°C
Wire Size AWG	18

Electrical

Current - Maximum per Contact	1.5A
Voltage - Maximum	15V DC

Solder Process Data

Process Temperature max. C	230
----------------------------	-----

Material Info

Reference - Drawing Numbers

Sales Drawing	SD-67926-001
---------------	--------------

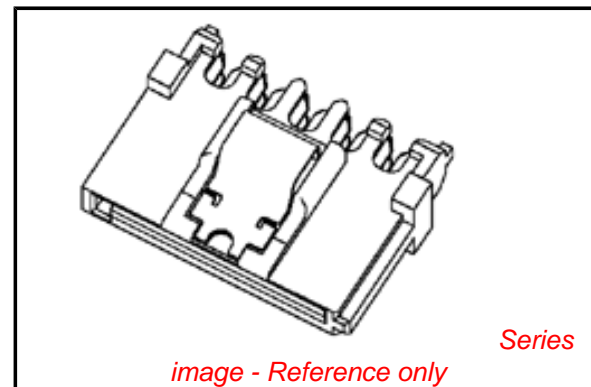

image - Reference only

EU RoHS

ELV and RoHS Compliant

REACH SVHC

Not Reviewed

Halogen-Free

Status

Not Halogen-Free

Need more information on product environmental compliance?

Email productcompliance@molex.com
 For a multiple part number RoHS Certificate of Compliance, [click here](#)

Please visit the [Contact Us](#) section for any non-product compliance questions.

China RoHS



Search Parts in this Series

[67926Series](#)

Mates With

[87679](#)

Application Tooling | FAQ

Tooling specifications and manuals are found by selecting the products below. Crimp Height Specifications are then contained in the Application Tooling Specification document.

Global

Description	Product #
Insertion Tool for 3.96mm (.156") Pitch KK® IDT Crimp Terminals	0638133503

PLEASE CHECK WWW.MOLEX.COM FOR LATEST PART INFORMATION

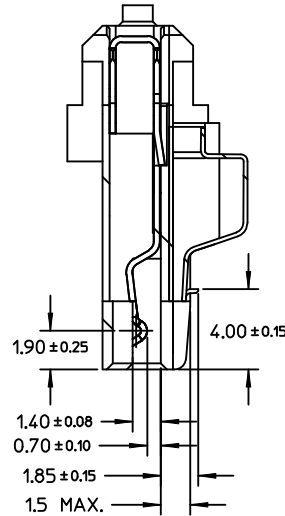
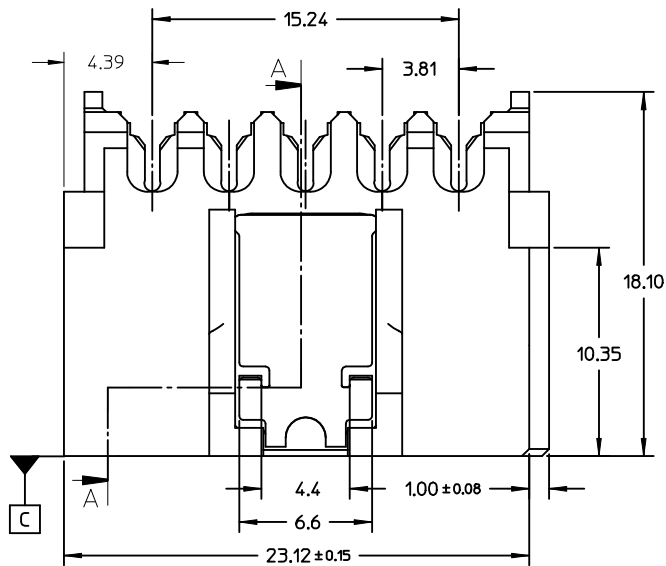

SECTION A-A

NOTES:

1. MATERIAL:

- HOUSING: THERMAL PLASTIC, G.F., UL94V-0, COLOR: BLACK
- COVER: THERMAL PLASTIC, COLOR: BLACK
- TERMINAL: COPPER ALLOY
- METAL LATCH: STAINLESS STEEL

2. TERMINAL PLATING:

- CONTACT AREA: GOLD PLATED
- IDT TAIL: PLATE TIN, 1.9 MICRONS MINIMUM
- UNDER PLATE: PLATE NICKEL 1.25 MICRONS MINIMUM

3. PACKAGING: TRAY

4. PRODUCT SPECIFICATION REFER TO PS-67490-001

5. ASSEMBLE WITH COVER 679260040/0041 AFTER WIRE TERMINATION

6. MATING PART 87679

7. RECOMMENDED TERMINATING WIRE SIZE: SEE TABLE

8. PRODUCT COMPLIANT TO RoHS DIRECTIVE 2002/95/EC AND ELV DIRECTIVE 2000/53/EC

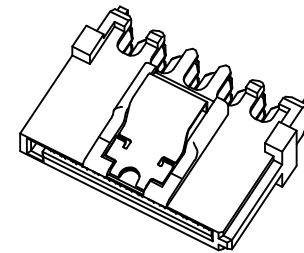

WITH LATCH TYPE

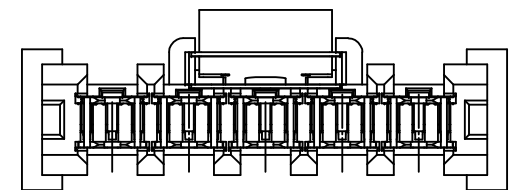
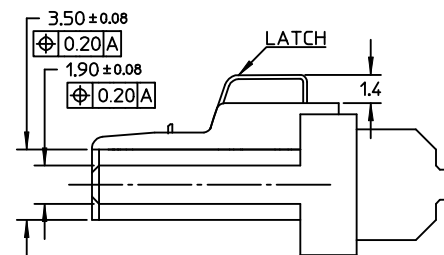
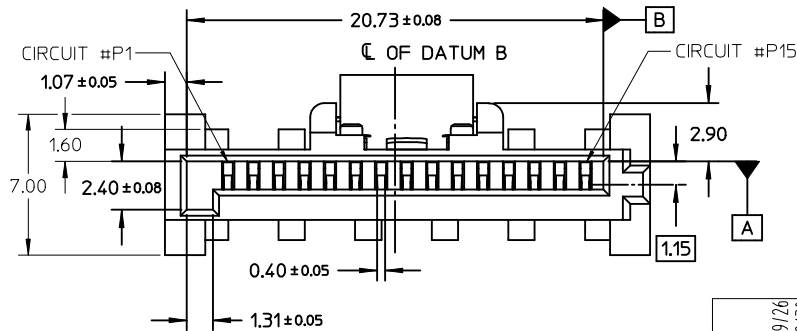

REVISED EC NO: SH2009-0098 DRW: CWTANG CHK: XJSONG APPR: HWANG	DESCRIPTION 2008/09/26 2008/09/30 2008/11/01	QUALITY SYMBOLS	GENERAL TOLERANCES (UNLESS SPECIFIED)		DIMENSION STYLE		SCALE	DESIGN UNITS	THIRD ANGLE PROJECTION	
		▽=0 ◻=0	mm	INCH	MM ONLY	4:1	METRIC			
		4 PLACES ± --- ± --- 3 PLACES ± --- ± --- 2 PLACES ± 0.25 ± --- 1 PLACE ± 0.3 ± ---	DRAWN BY DATE		TITLE		SERIAL ATA POWER CONNECTOR IDT TYPE MOLEX INCORPORATED			
		ANGULAR ± 1°	DRAWN BY DATE		TITLE					
DRAFT WHERE APPLICABLE MUST REMAIN WITHIN DIMENSIONS	MATERIAL NO.		DOCUMENT NO.		SHEET NO. 1 OF 3					
SIZE A3	THIS DRAWING CONTAINS INFORMATION THAT IS PROPRIETARY TO MOLEX INCORPORATED AND SHOULD NOT BE USED WITHOUT WRITTEN PERMISSION									

10 9 8 7 6 5 4 3 2 1

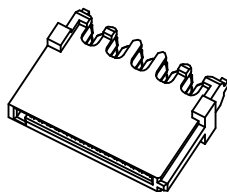
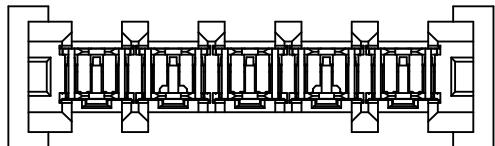

WITHOUT LATCH TYPE

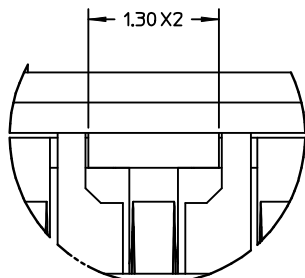
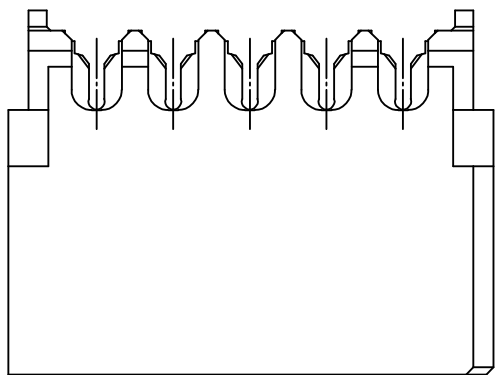

Detail2

SCALE 20:1

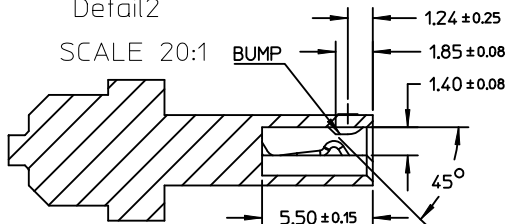

SECTION B-B

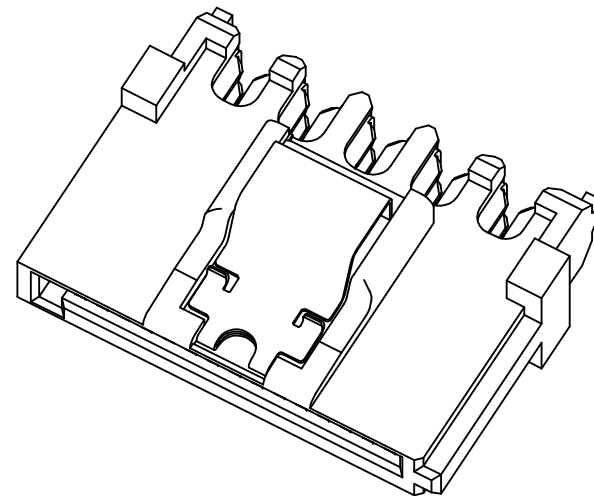
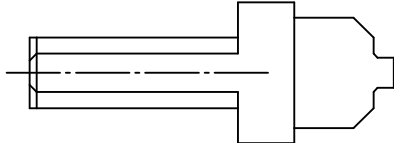

See Detail2

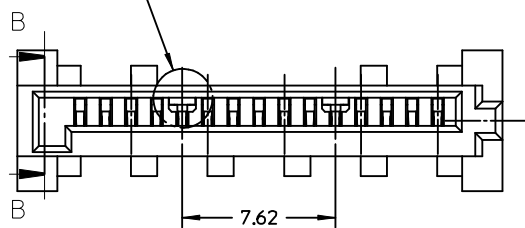

NOTES:
OTHER INFORMATION REFER TO SHEET 1

REVISED EC NO: SH2009-0098 G DRWIN: CWTANG CHKD: XJSONG APPR: HWANG	DESCRIPTION REV	QUALITY SYMBOLS	GENERAL TOLERANCES (UNLESS SPECIFIED)	DIMENSION STYLE	SCALE	DESIGN UNITS	THIRD ANGLE PROJECTION		
		▽=0 ⊕=0	mm INCH	MM ONLY	4:1	METRIC			
			4 PLACES ± --- ± --- 3 PLACES ± --- ± --- 2 PLACES ± 0.25 ± --- 1 PLACE ± 0.3 ± ---	DRAWN BY DATE GRATE MA 2004/01/17	CHECKED BY DATE YA JUN 2004/01/17	APPROVED BY DATE SAM 2004/01/17	TITLE SERIAL ATA POWER CONNECTOR IDT TYPE		
			ANGULAR ± 1 °	MATERIAL NO. SEE CHART	DOCUMENT NO. SD-67926-001	MOLEX INCORPORATED			
		DRAFT WHERE APPLICABLE MUST REMAIN WITHIN DIMENSIONS	SIZE A3	THIS DRAWING CONTAINS INFORMATION THAT IS PROPRIETARY TO MOLEX INCORPORATED AND SHOULD NOT BE USED WITHOUT WRITTEN PERMISSION					
							SHEET NO. 2 OF 3		

9 8 7 6 5 4 3 2 1

P/N	RECOMMENDED WIRE SIZE	PLATE TYPE	REMARK
67926-0001	18AWG	GOLD FLASH	WITH LATCH,WITHOUT BUMP
67926-0301	20AWG		
67926-0401	22AWG		
67926-0002	18AWG	0.76 MICRON GOLD PLATED	
67926-0302	20AWG		
67926-0402	22AWG		
67926-0005	18AWG	0.38 MICRON GOLD PLATED	
67926-0305	20AWG		
67926-0405	22AWG		
67926-0021	18AWG	GOLD FLASH	WITH LATCH,WITH BUMP
67926-0321	20AWG		
67926-0421	22AWG		
67926-0022	18AWG	0.76 MICRON GOLD PLATED	
67926-0322	20AWG		
67926-0422	22AWG		
67926-0025	18AWG	0.38 MICRON GOLD PLATED	
67926-0325	20AWG		
67926-0425	22AWG		
67926-0011	18AWG	GOLD FLASH	WITHOUT LATCH,WITH BUMP
67926-0311	20AWG		
67926-0411	22AWG		
67926-0012	18AWG	0.76 MICRON GOLD PLATED	
67926-0312	20AWG		
67926-0412	22AWG		
67926-0015	18AWG	0.38 MICRON GOLD PLATED	
67926-0315	20AWG		
67926-0415	22AWG		

REVISED EC NO: SH2009-0098 DRWN: CWTANG CHKD: XJSONG APPR: HWANG	2008/09/26 2008/09/30 2008/11/01	DESCRIPTION REV	QUALITY SYMBOLS	GENERAL TOLERANCES (UNLESS SPECIFIED)	DIMENSION STYLE	SCALE	DESIGN UNITS	THIRD ANGLE PROJECTION
			$\nabla = 0$ $\square = 0$	mm INCH	MM ONLY	4:1	METRIC	
			4 PLACES ± --- ± --- 3 PLACES ± --- ± --- 2 PLACES ± 0.25 ± --- 1 PLACE ± 0.3 ± --- ANGULAR ± 1 °	DRAWN BY DATE GRATE MA 2004/01/17 CHECKED BY DATE YA JUN 2004/01/17 APPROVED BY DATE SAM 2004/01/17	TITLE			
			DRAFT WHERE APPLICABLE MUST REMAIN WITHIN DIMENSIONS	MATERIAL NO. SEE CHART SIZE A3	MOLEX INCORPORATED DOCUMENT NO. SD-67926-001 SHEET NO. 3 OF 3			