

## CDBM140LR-G

**Reverse Voltage: 40 Volts**  
**Forward Current: 1.0 Amp**  
**RoHS Device**

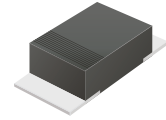

### Features

- Low reverse leakage current.
- High current capability, Low forward voltage drop .
- High surge capability .
- Guardring for over voltage protection.
- Ultra high-speed switching.
- Silicon epitaxial planar chip, metal silicon junction.

### Mechanical data

- Case: SOD-123F, molded plastic.
- Terminals: solderable per MIL-STD-750, method 2026
- Polarity: Color band denotes cathode end.
- Weight: 0.0004 ounces, 0.010 grams

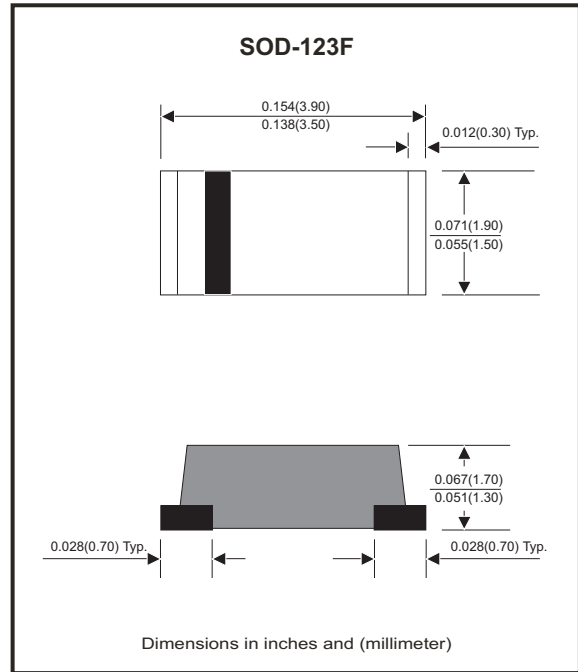

### Maximum Ratings (at TA=25°C unless otherwise noted)

Parameter	Conditions	Symbol	Min	Typ	Max	Unit
Maximum Recurrent peak reverse voltage		VRRM			40	V
Maximum RMS Voltage		VRMS			28	V
DC Blocking voltage		VDC			40	V
Operating temperature		TJ	-50		+125	°C

### Electrical Characteristics (at TA=25°C unless otherwise noted)

Parameter	Conditions	Symbol	Min	Typ	Max	Unit
Average forward current		Io			1	A
Forward current, surge peak	8.3ms single half sine-wave superimposed on rate load(JEDEC method)	IFSM			30	A
Forward voltage	IF = 1 A	VF		0.4	0.45	V
Reverse current	VR = 30 V , TA= 25°C	IR			200	uA
Thermal resistance	Junction to ambient	RθJA		98		°C/W
Diode Junction capacitance	f=1MHz and applied 4V DC reverse voltage	CJ		200		pF
Storage temperature		TSTG	-50		+150	°C

## RATING AND CHARACTERISTIC CURVES (CDBM140LR-G)

Fig.1 Typical Forward Current Derating Curve

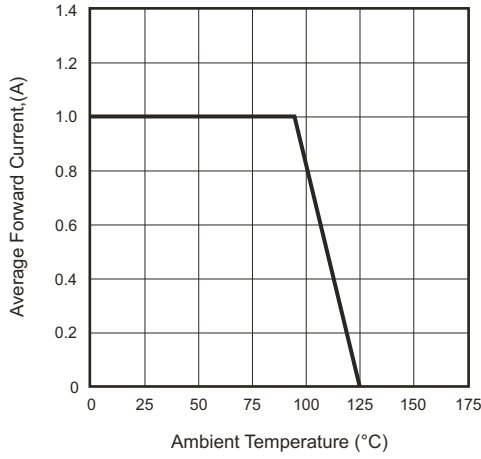

Fig.2 Typical Forward Characteristics

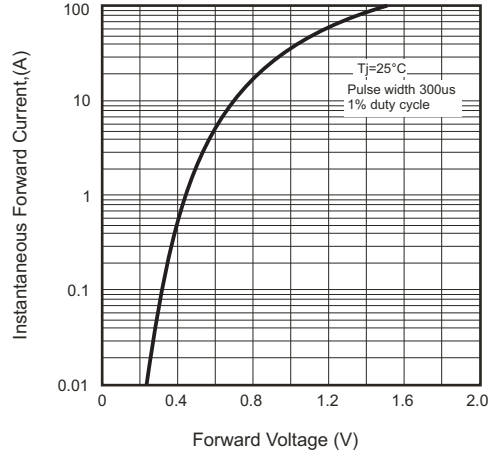

Fig.3 Non-repetitive Forward Surge Current

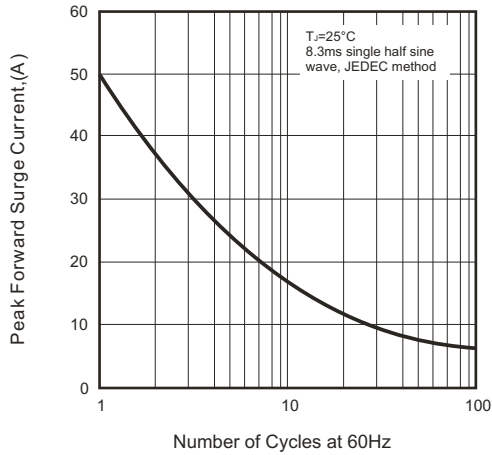

Fig.4 -Typical Reverse Characteristics

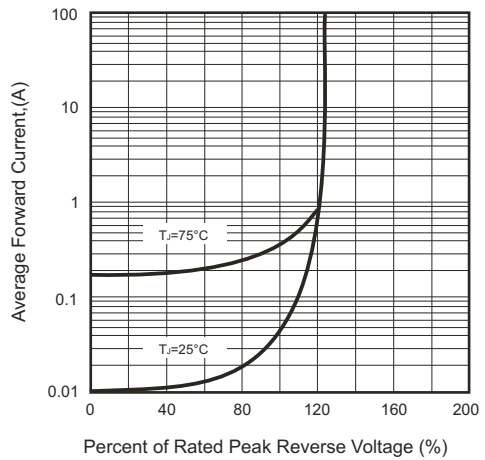
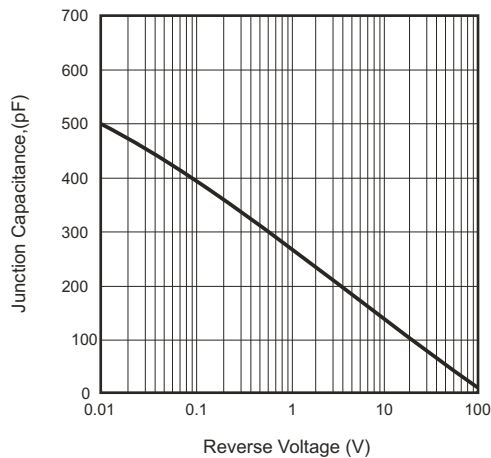
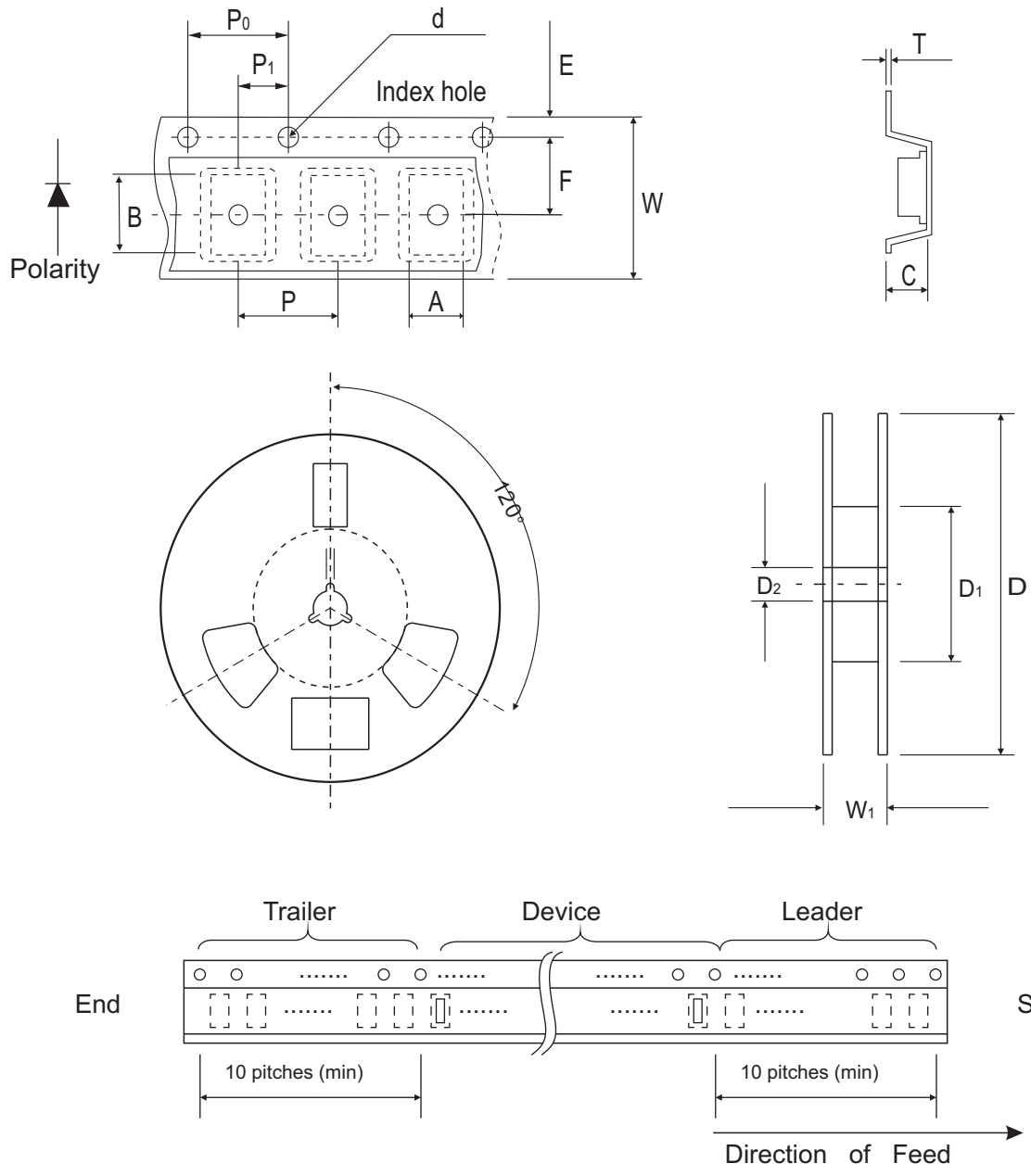

Fig.5 Typical Junction Capacitance



## Reel Taping Specification



SOD-123F	SYMBOL	A	B	C	d	D	D1	D2
	(mm)	1.90 ± 0.10	3.90 ± 0.10	1.68 ± 0.10	1.50 ± 0.10	178.00 ± 2.00	62.00 MIN.	13.0 ± 0.50
	(inch)	0.075 ± 0.004	0.154 ± 0.004	0.114 ± 0.004	0.059 ± 0.004	7.008 ± 0.079	2.441 MIN.	0.512 ± 0.020

SOD-123F	SYMBOL	E	F	P	P0	P1	W	W1
	(mm)	1.75 ± 0.10	3.50 ± 0.10	4.00 ± 0.10	4.00 ± 0.10	2.00 ± 0.10	8.00 ± 0.30	11.40 ± 1.0
	(inch)	0.069 ± 0.004	0.138 ± 0.004	0.157 ± 0.004	0.157 ± 0.004	0.079 ± 0.002	0.315 ± 0.008	0.449 ± 0.039

## Marking Code

Part Number	Marking Code
CDBM140LR-G	24



xx = Product type marking code

## Suggested PAD Layout

SIZE	SOT-123F	
	(mm)	(inch)
A	1.90	0.075
B	1.40	0.055
C	1.90	0.075
D	3.30	0.130
E	4.70	0.185

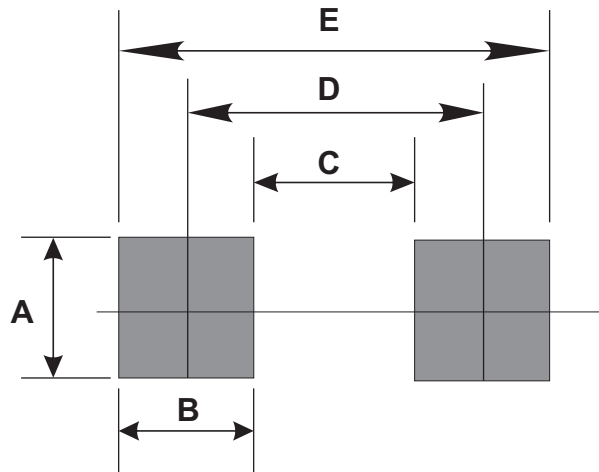

## Standard Packaging

Case Type	REEL PACK	
	REEL ( pcs )	Reel Size (inch)
SOT-123F	2,500	7