

RoHS

K78XX-2000(L) Series

**WIDE INPUT NON-ISOLATED & REGULATED
SINGLE OUTPUT**

FEATURES

- Efficiency up to 92%, No heatsink required
- 2A large current output
- Operating temperature : -40°C ~ +85°C
- Short circuit protection, thermal shutdown
- Low ripple and noise
- Micro miniature SIP package, meet UL94-V0 requirement
- Ultra low power loss
- Industry standard pinout
- Pin-out compatible with LM78XX Linear
- MTBE>2000,000Hours

APPLICATIONS

Upgraded K78xx-2000(L) series switching regulators are ideal replacement for K78xx linear regulators and LDOs. The efficiency of up to 92% means that very little energy is wasted as heat so there is no need for any heat sinks with their additional space and mounting costs. They are widely used in industrial control, instrumentation, and electric power applications.

MODEL SELECTION

K7805-2000

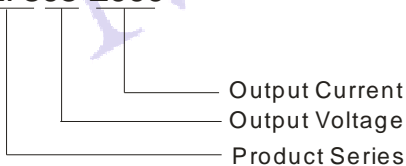

MORNSUN Science & Technology Co.,Ltd.

Address: No. 5, Kehui St. 1, Kehui development center, Science Ave., Guangzhou Science City, Luogang district, Guangzhou, P.R.China.

Tel: 86-20-28203030

Fax: 86-20-28203068

[Http://www.mornsun-power.com](http://www.mornsun-power.com)

PRODUCT PROGRAM

Part Number	Input Voltage(VDC)		Output		Efficiency (%) (Typ.)	
	Nominal	Range	Voltage (VDC)	Current (mA)	Vin (min.)	Vin (max.)
K7801-2000(L)	12	4.75-18	1.5	2000	79	76
K78X2-2000(L)	12	4.75-18	1.8	2000	81	79
K7802-2000(L)	12	4.75-18	2.5	2000	85	83
K7803-2000(L)	12	4.75-18	3.3	2000	87	86
K7805-2000(L)	12	7-18	5	2000	91	88
K78X6-2000(L)	12	8.5-18	6.5	2000	92	91

Add suffix "L" for 90° bend pins, for example: K7805-2000L.

OUTPUT SPECIFICATIONS

Item	Test conditions	Min.	Typ.	Max.	Units
Output voltage accuracy	100% full load, input voltage range		±2	±3	%
Line regulation	Vin=min. to max, at full load		±0.5	±0.75	
Load regulation	10% to 100% load		±0.5	±1.0	
Ripple & Noise*	20MHz bandwidth (refer to figure 6)		25	45	mVp-p
Short circuit input power			0.5	1.8	W
Short circuit protection		Continuous, auto-recovery			
Thermal shutdown	Internal IC junction		150		°C
Output current limit			5000		mA
Switching frequency	Full load, input voltage range	300	340	380	KHz
Quiescent current			5	10	mA
Temperature coefficient	-40°C ~ +85°C ambient			±0.03	%/°C
Max capacitance load				1000	µF

*Test ripple and noise by "parallel cable" method.

COMMON SPECIFICATIONS

Operating temp. range	-40~+85 °C (above 71°C power derating)	
Operating case temp.	+100 °C (max)	
Storage temp. range	-55~+125 °C	
Cooling	Free air convection	
Lead temperature**	300 °C (max)	
Storage humidity range	≤ 95%	
Case material	Plastic(UL94-V0)	
MTBF	> 2000k hours (25°C, MIL-HDBK-217F)	
Weight	4.0g	
Conducted emissions (Refer to Figure 5)	EN55022	CLASS B
Radiated emissions	EN55022	CLASS B
ESD	EN61000-4-2 Level 3 6kV/8kV perf. Criteria B	

**1.5mm from case for 10 seconds

TYPICAL CHARECTERISTICS

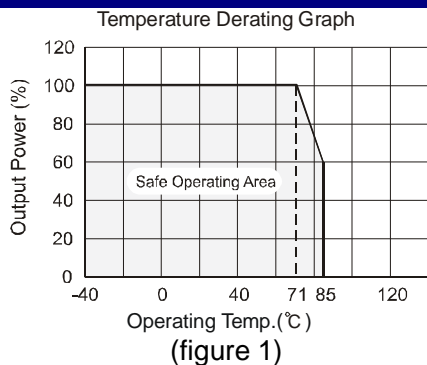

EXTERNAL CAPACITOR TABLE

Part Number	C1 (Ceramic capacitor)	C2 (Ceramic capacitor)
K7801-2000(L)	10 μ F/25V	22 μ F/6.3V
K78X2-2000(L)	10 μ F/25V	22 μ F/6.3V
K7802-2000(L)	10 μ F/25V	22 μ F/6.3V
K7803-2000(L)	10 μ F/25V	22 μ F/6.3V
K7805-2000(L)	10 μ F/25V	22 μ F/16V
K78X6-2000(L)	10 μ F/25V	22 μ F/16V

TYPICAL APPLICATION CIRCUIT

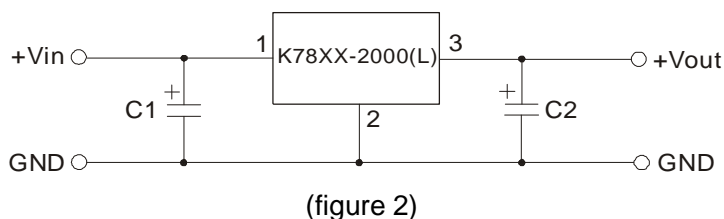

Note:

1. C1 and C2 are required and should be fitted close to the converter pins.
2. The capacitance of C1 and C2 sees external capacitor table, it can be increased properly if required, and tantalum or low ESR electrolytic capacitors may also suffice.
3. No parallel connection or plug and play.

INPUT FILTER CIRCUIT CONNECT

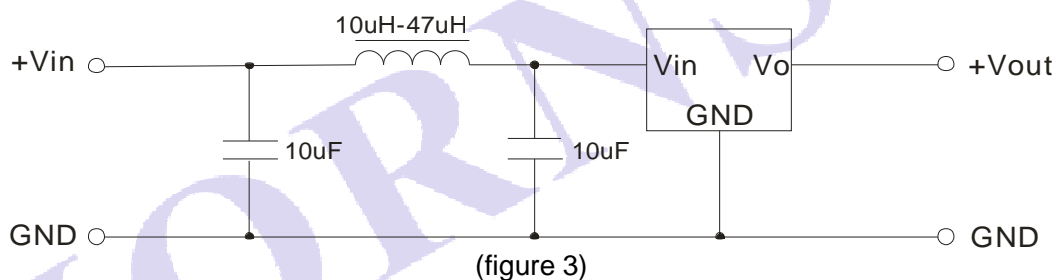

OUTPUT FILTER CIRCUIT CONNECT

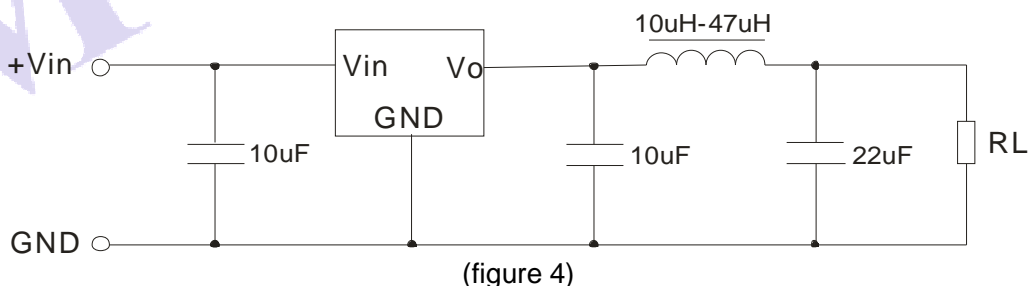

EMC RECOMMENDED CIRCUIT

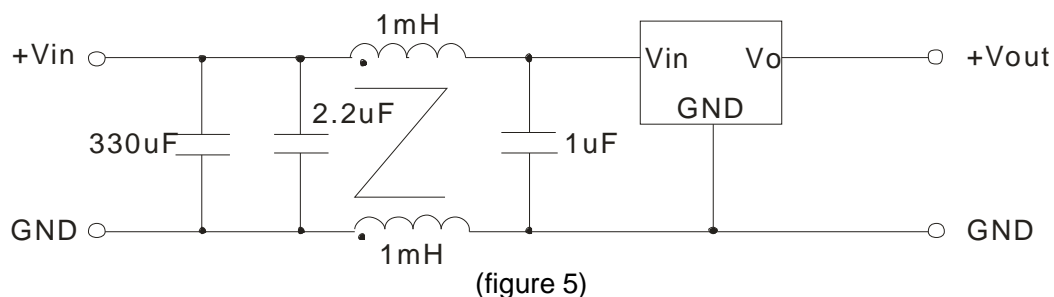

TEST CONFIGURATIONS (TA=25°C)

1 Efficiency and Output Voltage Ripple Test

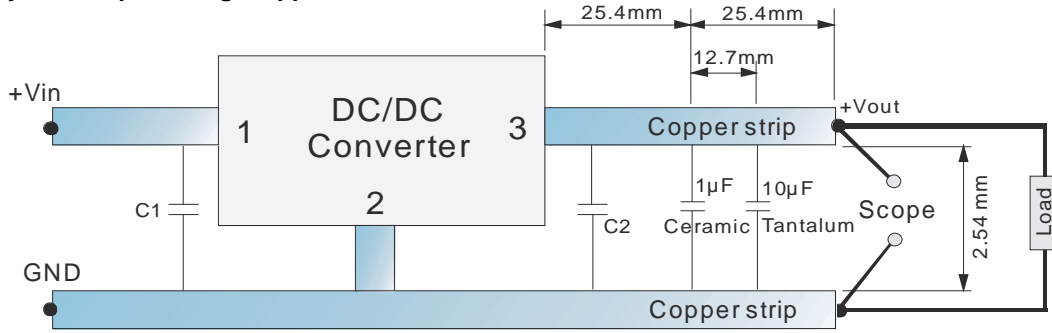

(figure 6)

2 Start-up and Load Transient Response Test

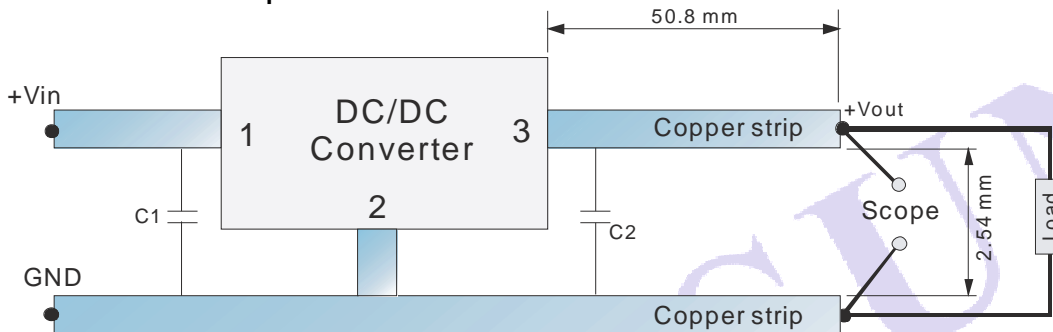

(figure 7)

CHARACTERISTICS CURVE

Efficiency

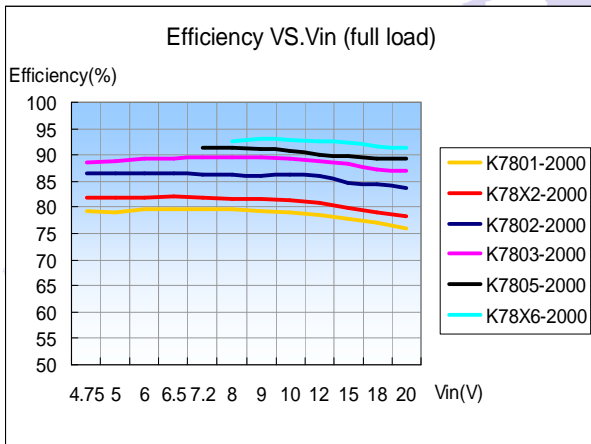

Ripple

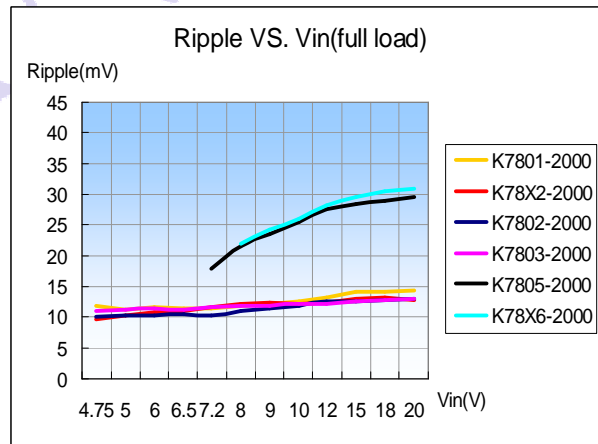

Efficiency VS. Load(Vin=12V)

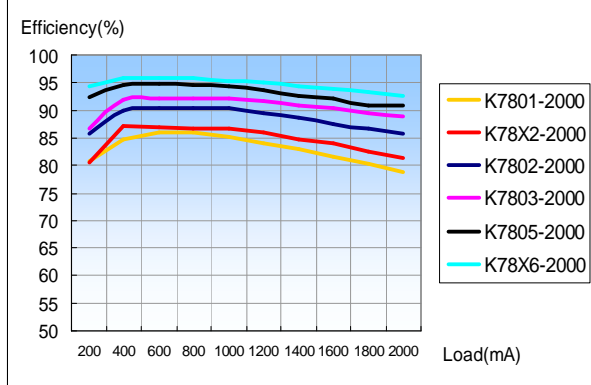

Ripple VS. Load(Vin=12V)

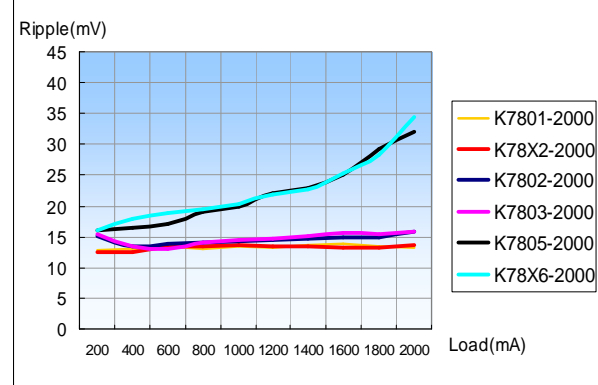

OUTLINE DIMENSIONS & FOOTPRINT DETAILS

MECHANICAL DIMENSIONS

K78XX-2000

Note:
Unit:mm[inch]
Pin section tolerances:± 0.10mm[± 0.004inch]
General tolerances:± 0.25mm[± 0.010inch]

K78XX-2000L

Note:
Unit:mm[inch]
Pin section tolerances± 0.10mm[± 0.004inch]
General tolerances:± 0.25mm[± 0.010inch]

RECOMMENDED FOOTPRINT

K78XX-2000

K78XX-2000L

Note:
grid:2.54*2.54mm.

FOOTPRINT DETAILS	
Pin	Function
1	+Vin
2	GND
3	+Vout

TUBE OUTLINE DIMENSIONS

K78XX-2000

K78XX-2000L

Note:
Unit :mm[inch]
General tolerances: ±0.50mm[±0.020inch]
L=530mm[20.866inch] Devices per tube quantity: 44pcs
L=220mm[8.661inch] Devices per tube quantity: 17pcs
Short tube inner packaging dimensions: L*W*H=255*170*80mm
Short tube outer packaging dimensions(with six inner packaging boxes):
L*W*H=375*280*270mm
Long tube inner packaging dimensions: L*W*H=580*200*100mm
Long tube outer packaging dimensions(with two inner packaging boxes):
L*W*H=600*215*220mm
Long tube outer packaging dimensions(with three inner packaging boxes):
L*W*H=600*215*325mm

- Note:
1. All specifications measured at Ta=25°C, humidity<75%, nominal input voltage and rated output load unless otherwise specified.
 2. Only typical models listed, other models may be different, please contact our technical person for more details.
 3. In this datasheet, all the test methods of indications are based on corporate standards.