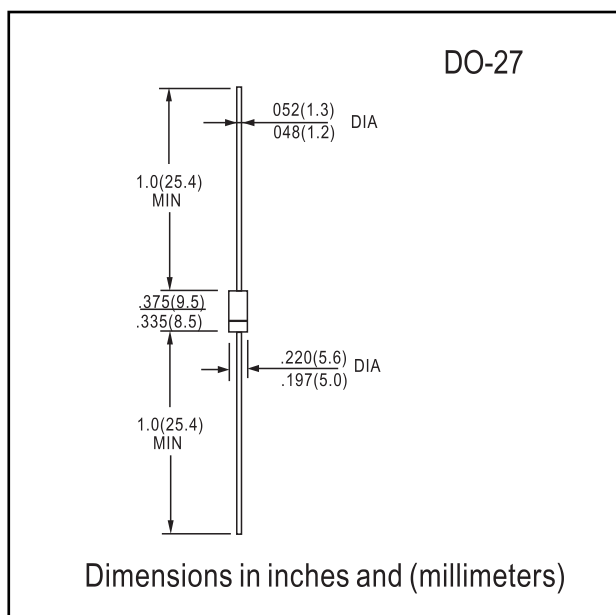

**TAYCHIPST****FAST RECOVERY RECTIFIER****PR3001 THRU PR3005****50V-600V 3.0A****FEATURES**

- Diffused Junction
- Fast Switching for High Efficiency
- High Current Capability and Low Forward Voltage Drop
- Surge Overload Rating to 150 A Peak
- Low Reverse Leakage Current
- Plastic Material: UL Flammability Classification Rating 94V-0

MECHANICAL DATA

- Case: Molded Plastic
- Terminals: Plated Leads Solderable per MIL-STD-202, Method 208
- Polarity: Cathode Band
- Marking: Type Number
- Weight: 1.12 grams (approx.)

**MAXIMUM RATINGS AND ELECTRICAL CHARACTERISTICS**

Single phase, half wave, 60Hz, resistive or inductive load.
For capacitive load, derate current by 20%.

Characteristic	Symbol	PR 3001	PR 3002	PR 3003	PR 3004	PR 3005	Unit
Peak Repetitive Reverse Voltage Working Peak Reverse Voltage DC Blocking Voltage	V_{RRM} V_{RWM} V_R	50	100	200	400	600	V
RMS Reverse Voltage	$V_{R(RMS)}$	35	70	140	280	420	V
Average Rectified Output Current (Note 1) @ $T_A = 90^\circ\text{C}$	I_O	3.0					A
Non-Repetitive Peak Forward Surge Current 8.3ms Single half sine-wave Superimposed on Rated Load (JEDEC Method)	I_{FSM}	150					A
Forward Voltage @ $I_F = 3.0\text{A}$	V_{FM}	1.2					V
Peak Reverse Current @ $T_A = 25^\circ\text{C}$ at Rated DC Blocking Voltage @ $T_A = 100^\circ\text{C}$	I_{RM}	5.0 100					μA
Reverse Recovery Time (Note 3)	t_{rr}	150				250	ns
Typical Junction Capacitance (Note 2)	C_j	50					pF
Typical Thermal Resistance Junction to Ambient	$R_{\theta JA}$	15					K/W
Operating and Storage Temperature Range	T_j, T_{STG}	-65 to +150					$^\circ\text{C}$

- Notes:
1. Valid provided that leads are maintained at ambient temperature at a distance of 9.5mm from the case.
 2. Measured at 1.0MHz and applied reverse voltage of 4.0V DC.
 3. Measured with $I_F = 0.5\text{A}$, $I_R = 1.0\text{A}$, $I_{rr} = 0.25\text{A}$. See figure 5.



RATINGS AND CHARACTERISTIC CURVES PR3001 THRU PR3005

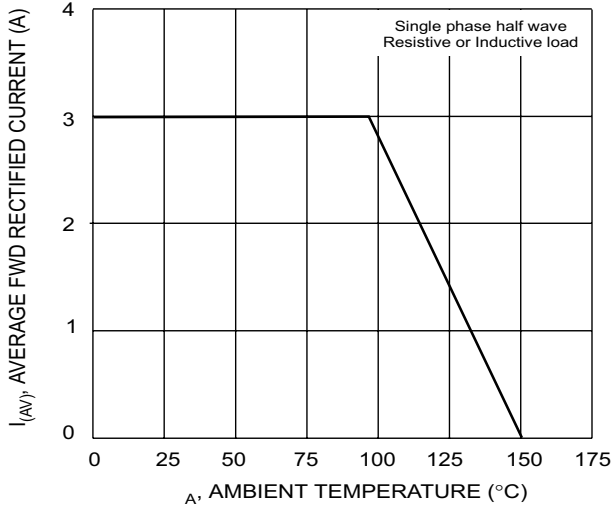

Fig. 1 Forward Derating Curve

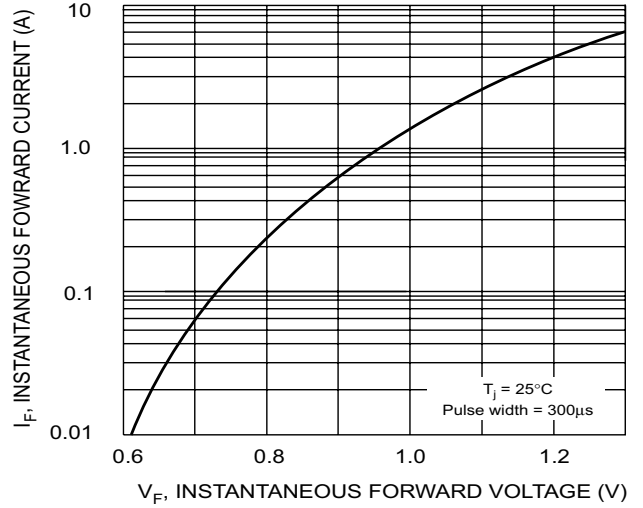

Fig. 2 Typical Forward Characteristics

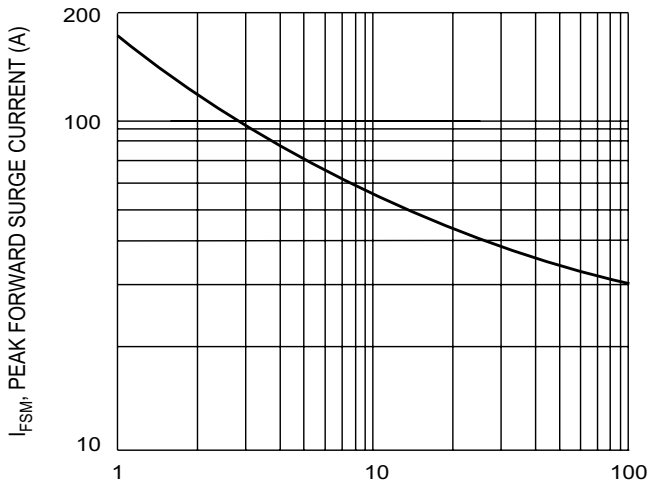

Fig. 3 Peak Forward Surge Current

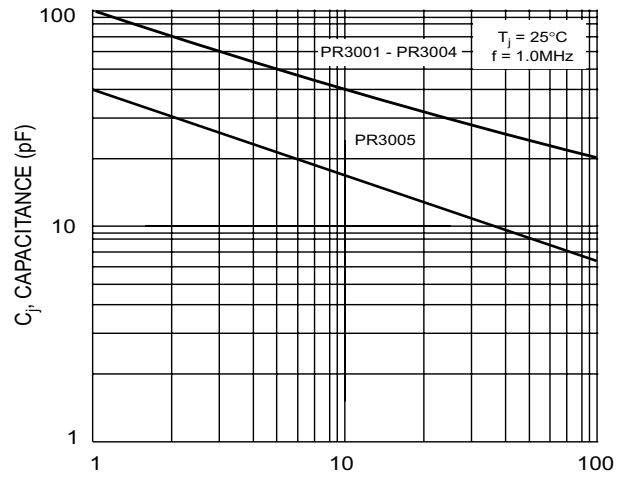
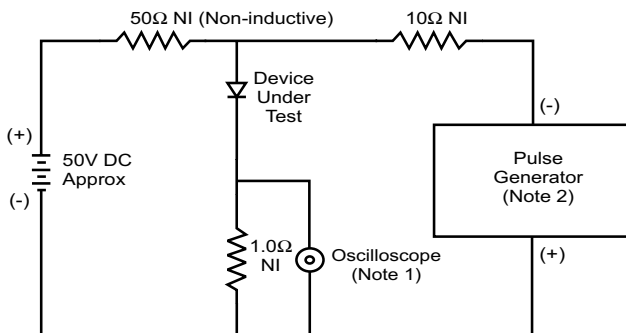
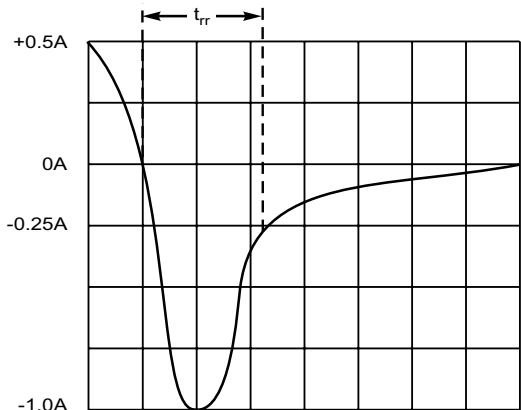

Fig. 4 Typical Junction Capacitance



- Notes:
1. Rise Time = 7.0ns max. Input Impedance = 1.0MΩ, 22pF.
 2. Rise Time = 10ns max. Input Impedance = 50Ω.



Set time base for 50/100 ns/cm

Fig. 5 Reverse Recovery Time Characteristic and Test Circuit