

MITSUBISHI Nch POWER MOSFET

FS100VSJ-03

HIGH-SPEED SWITCHING USE

FS100VSJ-03

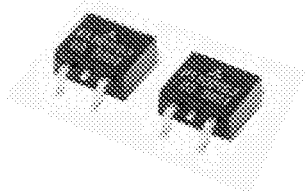

- ∧ 4V DRIVE
- ∧ V_{DSS} 30V
- ∧ r_{DS (ON)} (MAX) 4.7mΩ
- ∧ I_D 100A
- ∧ Integrated Fast Recovery Diode (TYP.) 100ns

OUTLINE DRAWING

Dimensions in mm

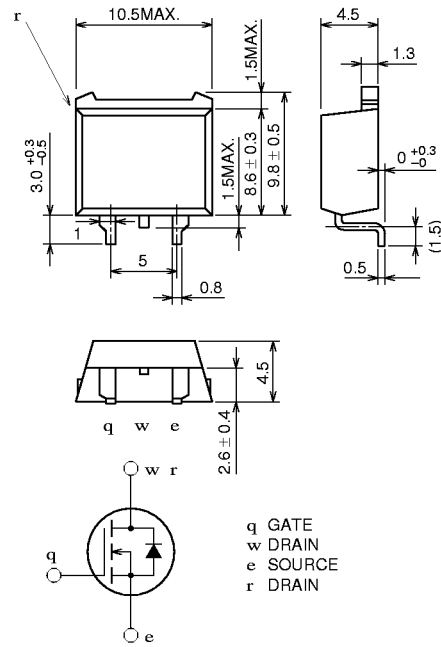

TO-220S

APPLICATION

Motor control, Lamp control, Solenoid control
DC-DC converter, etc.

MAXIMUM RATINGS (T_c = 25°C)

Symbol	Parameter	Conditions	Ratings	Unit
V _{DSS}	Drain-source voltage	V _{GS} = 0V	30	V
V _{GSS}	Gate-source voltage	V _{DS} = 0V	±20	V
I _D	Drain current		100	A
I _{DM}	Drain current (Pulsed)		400	A
I _{DA}	Avalanche drain current (Pulsed)	L = 30μH	100	A
I _S	Source current		100	A
I _{SM}	Source current (Pulsed)		400	A
P _D	Maximum power dissipation		125	W
T _{ch}	Channel temperature		-55 ~ +150	°C
T _{stg}	Storage temperature		-55 ~ +150	°C
—	Weight	Typical value	1.2	g

Feb.1999

FS100VSJ-03

HIGH-SPEED SWITCHING USE

ELECTRICAL CHARACTERISTICS (T_{ch} = 25°C)

Symbol	Parameter	Test conditions	Limits			Unit
			Min.	Typ.	Max.	
V _{(BR)DSS}	Drain-source breakdown voltage	I _D = 1mA, V _{GS} = 0V	30	—	—	V
I _{GSS}	Gate-source leakage current	V _{GS} = ±20V, V _{DS} = 0V	—	—	±0.1	μA
I _{DSS}	Drain-source leakage current	V _{DS} = 30V, V _{GS} = 0V	—	—	0.1	mA
V _{GS(th)}	Gate-source threshold voltage	I _D = 1mA, V _{DS} = 10V	1.0	1.5	2.0	V
r _{DS(on)}	Drain-source on-state resistance	I _D = 50A, V _{GS} = 10V	—	3.5	4.7	mΩ
r _{DS(on)}	Drain-source on-state resistance	I _D = 50A, V _{GS} = 4V	—	4.7	8.0	mΩ
V _{DS(on)}	Drain-source on-state voltage	I _D = 50A, V _{GS} = 10V	—	0.175	0.235	V
y _{fs}	Forward transfer admittance	I _D = 50A, V _{DS} = 10V	—	80	—	S
C _{iss}	Input capacitance	V _{DS} = 10V, V _{GS} = 0V, f = 1MHz	—	8000	—	pF
C _{oss}	Output capacitance		—	2250	—	pF
C _{rss}	Reverse transfer capacitance		—	1300	—	pF
t _{d(on)}	Turn-on delay time	V _{DD} = 15V, I _D = 50A, V _{GS} = 10V, R _{GEN} = R _{GS} = 50Ω	—	55	—	ns
t _r	Rise time		—	190	—	ns
t _{d(off)}	Turn-off delay time		—	800	—	ns
t _f	Fall time		—	470	—	ns
V _{SD}	Source-drain voltage	I _S = 50A, V _{GS} = 0V	—	1.0	1.5	V
R _{th(ch-c)}	Thermal resistance	Channel to case	—	—	1.00	°C/W
t _{rr}	Reverse recovery time	I _S = 50A, dis/dt = -50A/μs	—	100	—	ns

PERFORMANCE CURVES

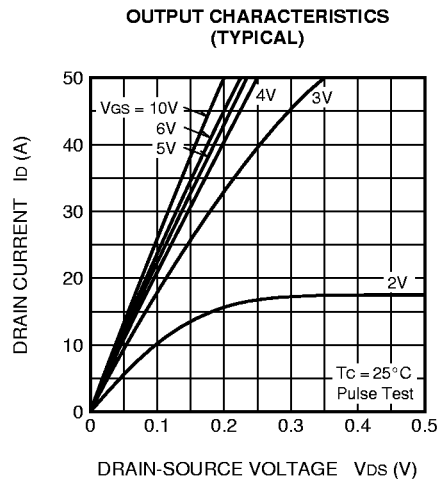
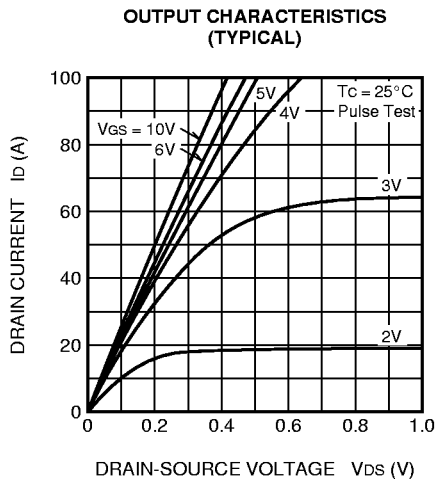
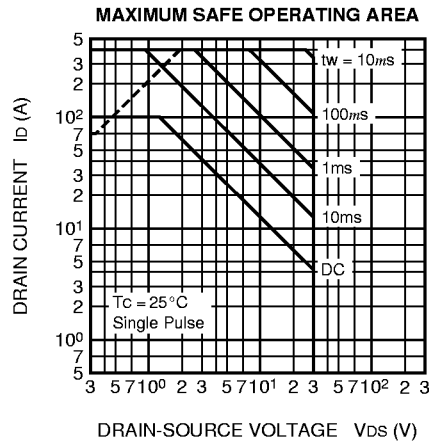
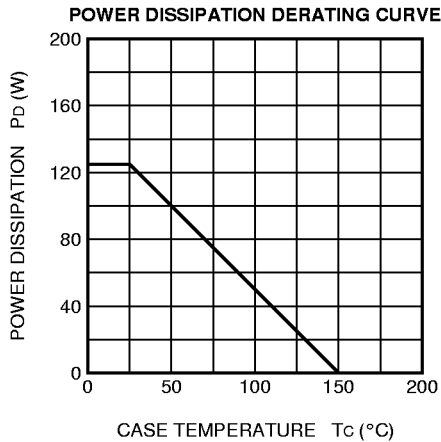

FS100VSJ-03

HIGH-SPEED SWITCHING USE

ON-STATE VOLTAGE VS. GATE-SOURCE VOLTAGE (TYPICAL)

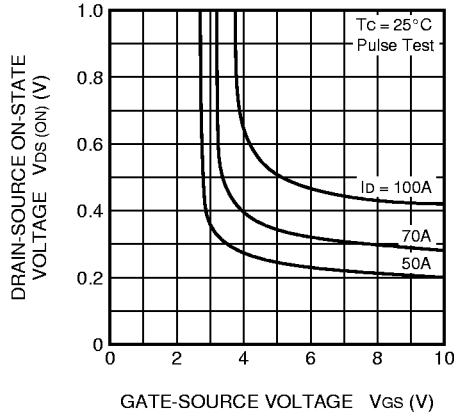

ON-STATE RESISTANCE VS. DRAIN CURRENT (TYPICAL)

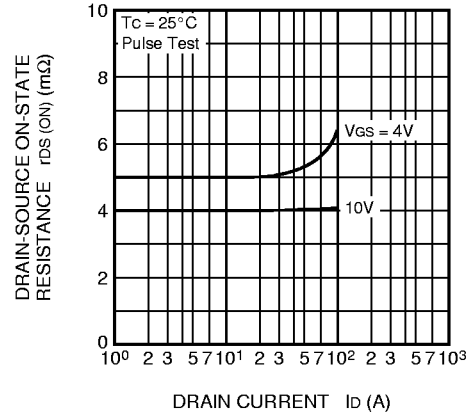

TRANSFER CHARACTERISTICS (TYPICAL)

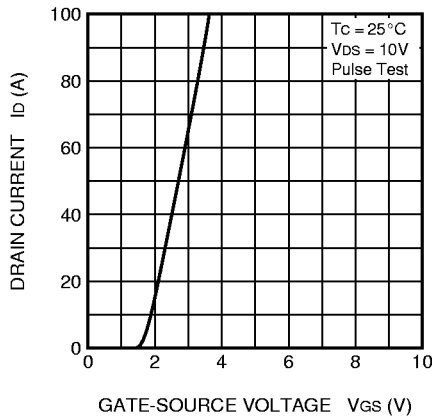

FORWARD TRANSFER ADMITTANCE VS. DRAIN CURRENT (TYPICAL)

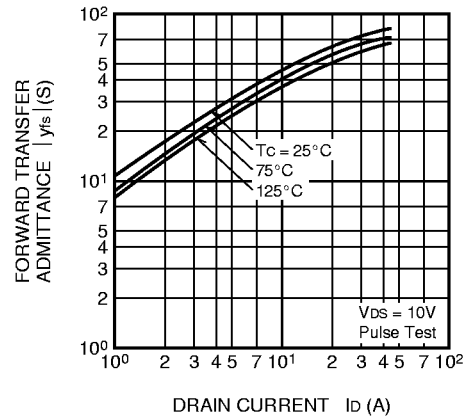

CAPACITANCE VS. DRAIN-SOURCE VOLTAGE (TYPICAL)

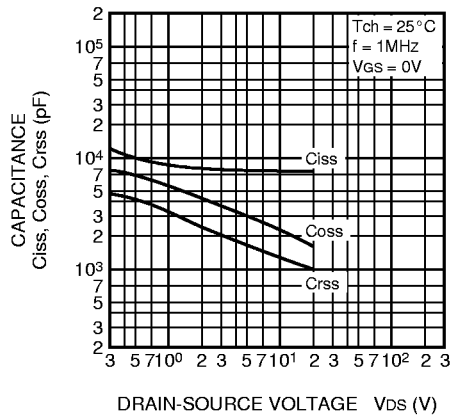

SWITCHING CHARACTERISTICS (TYPICAL)

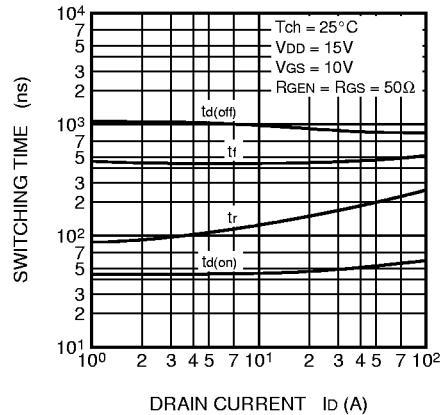

FS100VSJ-03

HIGH-SPEED SWITCHING USE

GATE-SOURCE VOLTAGE VS. GATE CHARGE (TYPICAL)

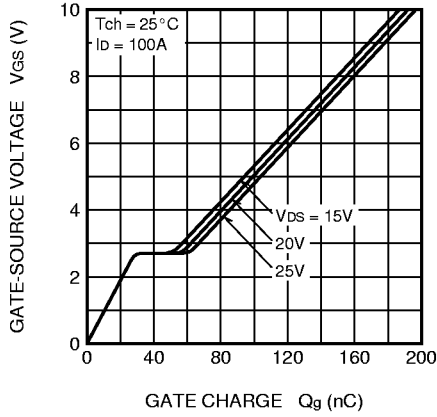

SOURCE-DRAIN DIODE FORWARD CHARACTERISTICS (TYPICAL)

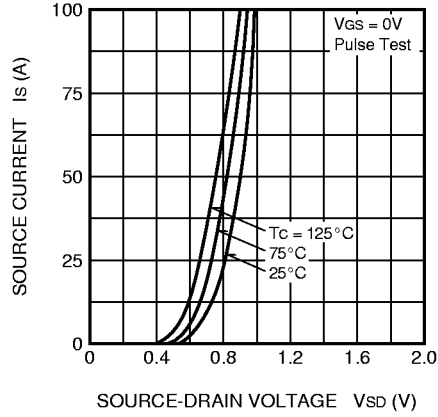

ON-STATE RESISTANCE VS. CHANNEL TEMPERATURE (TYPICAL)

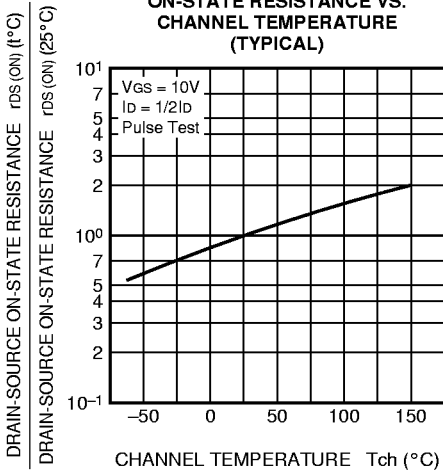

THRESHOLD VOLTAGE VS. CHANNEL TEMPERATURE (TYPICAL)

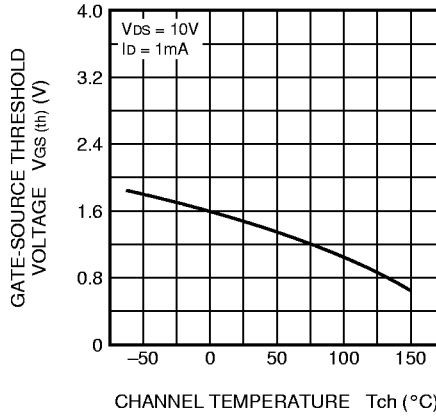

BREAKDOWN VOLTAGE VS. CHANNEL TEMPERATURE (TYPICAL)

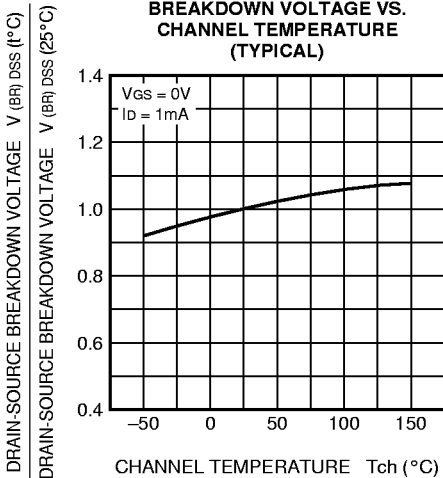

TRANSIENT THERMAL IMPEDANCE CHARACTERISTICS

