



DC COMPONENTS CO., LTD.

RECTIFIER SPECIALISTS

**1N4933
THRU
1N4937**

TECHNICAL SPECIFICATIONS OF FAST RECOVERY RECTIFIER
VOLTAGE RANGE - 50 to 600 Volts **CURRENT - 1.0 Ampere**

FEATURES

- * Low cost
- * Low leakage
- * Low forward voltage drop
- * High current capability

MECHANICAL DATA

- * Case: Molded plastic
- * Epoxy: UL 94V-0 rate flame retardant
- * Lead: MIL-STD-202E, Method 208 guaranteed
- * Mounting position: Any
- * Weight: 0.33 gram

MAXIMUM RATINGS AND ELECTRICAL CHARACTERISTICS

Ratings at 25 °C ambient temperature unless otherwise specified.
 Single phase, half wave, 60 Hz, resistive or inductive load.
 For capacitive load, derate current by 20%.



DO-41

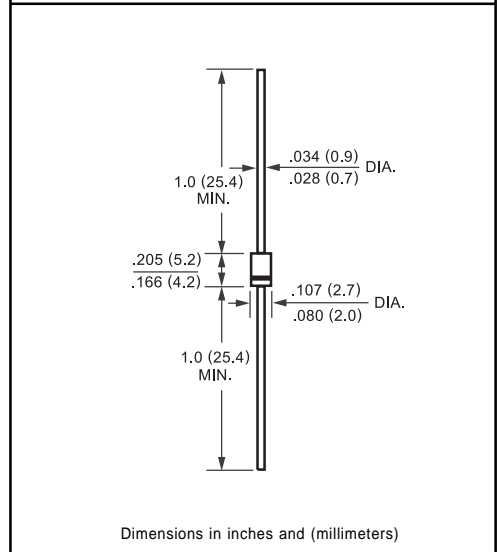

Dimensions in inches and (millimeters)

	SYMBOL	1N4933	1N4934	1N4935	1N4936	1N4937	UNITS
Maximum Recurrent Peak Reverse Voltage	VRRM	50	100	200	400	600	Volts
Maximum RMS Voltage	VRMS	35	70	140	280	420	Volts
Maximum DC Blocking Voltage	VDC	50	100	200	400	600	Volts
Maximum Average Forward Rectified Current at TA = 75°C	Io	1.0					Amps
Peak Forward Surge Current 8.3 ms single half sine-wave superimposed on rated load (JEDEC Method)	IFSM	30					Amps
Maximum Instantaneous Forward Voltage at 1.0A DC	VF	1.3					Volts
Maximum DC Reverse Current at Rated DC Blocking Voltage TA = 25°C	IR	5.0					uAmps
Maximum Full Load Reverse Current Full Cycle Average, .375"(9.5mm) lead length at TL = 55°C		100					uAmps
Maximum Reverse Recovery Time (Note 1)	trr	150			250		nSec
Typical Junction Capacitance (Note 2)	CJ	15					pF
Operating and Storage Temperature Range	TJ, TSTG	-65 to + 150					°C

NOTES : 1. Test Conditions: IF = 0.5A, IR = 1.0A, IRR = 0.25A
 2. Measured at 1 MHz and applied reverse voltage of 4.0 volts

RATING AND CHARACTERISTIC CURVES (1N4933 THRU 1N4937)

FIG. 1 - TYPICAL FORWARD CURRENT DERATING CURVE

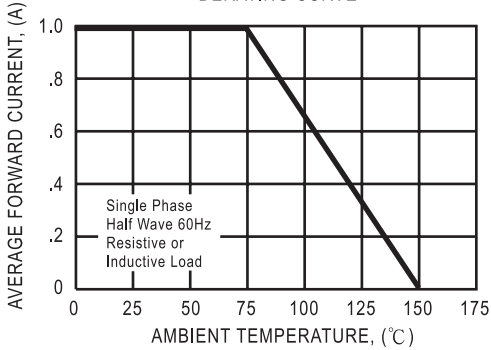

FIG. 2 - MAXIMUM NON-REPETITIVE FORWARD SURGE CURRENT

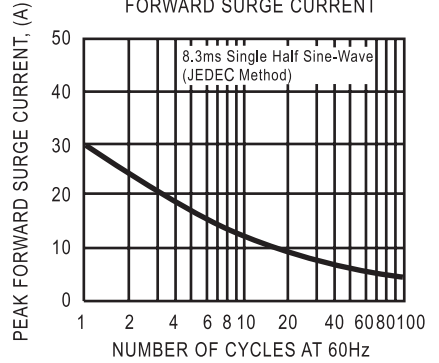

FIG. 3 - TYPICAL JUNCTION CAPACITANCE

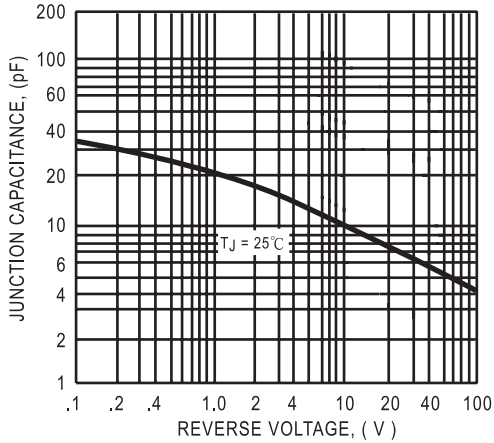

FIG. 4 - TYPICAL INSTANTANEOUS FORWARD CHARACTERISTICS

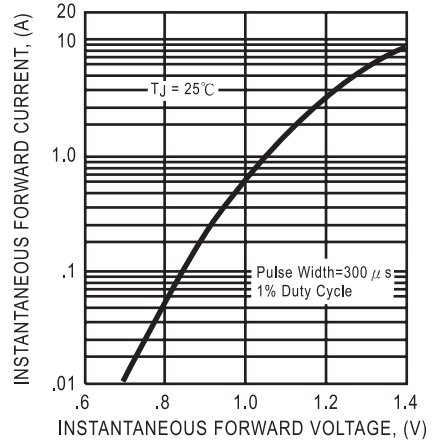
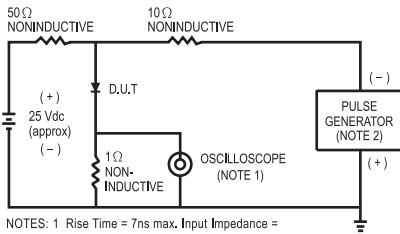
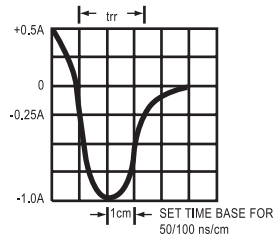

FIG. 5 - TEST CIRCUIT DIAGRAM AND REVERSE RECOVERY TIME CHARACTERISTIC



NOTES: 1 Rise Time = 7ns max. Input Impedance = 1 megohm, 22pF.
2. Rise Time = 10ns max. Source Impedance = 50 ohms.



DC COMPONENTS CO., LTD.