

# SONY CXA1464AS/CXA1465AS

Color TV Y/C/Jungle/RGB Interface/Deflection Compensation

## Description

CXA1464AS/CXA1465AS is bipolar ICs, each having the NTSC color TV luminance signal processing, chrominance signal processing, sync signal processing, RGB interface, auto cut-off, and deflection compensation functions integrated into a chip.

## Features

- Compatible with I<sup>2</sup>C bus. Two bus lines SDA and SCL drive 23 self-contained D/A converters to provide various types of adjustments and user controls.
- Has a Deflection compensation circuit which facilitates adjustments for compensation of deflection distortion.
- Has an auto cut-off function for automatic CRT cut-off adjustment and compensation for changes with time.
- Has built-in dynamic picture capability.
- Has multiple inputs (Y/C separate inputs, analog R, G and B inputs, digital R, G and B inputs for screen display).
- Wide band R, G and B interface (typ. -3dB at 20MHz)

## Absolute Maximum Ratings (Ta=25°C)

• Supply voltage	V <sub>CC</sub>	12	V
• Operating temperature	T <sub>opr</sub>	-20 to +75	°C
• Storage temperature	T <sub>stg</sub>	-65 to +150	°C
• Allowable power dissipation	P <sub>D</sub>	1.9	W

## Operating Condition

• Supply voltage	V <sub>CC</sub>	8.5 to 9.5	V
------------------	-----------------	------------	---

48pin SDIP (Plastic)

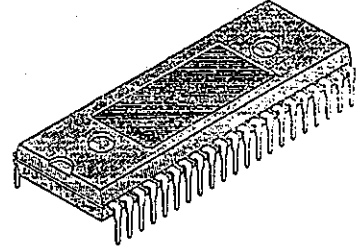

## Applications

TV sets

Note that the CXA1464AS and CXA1465AS are different in demodulation axis.

CXA1464AS: Compatible with Japanese standard

CXA1465AS: Compatible with U.S.A. standard

## Structure

Bipolar silicon monolithic IC



Pin Configuration

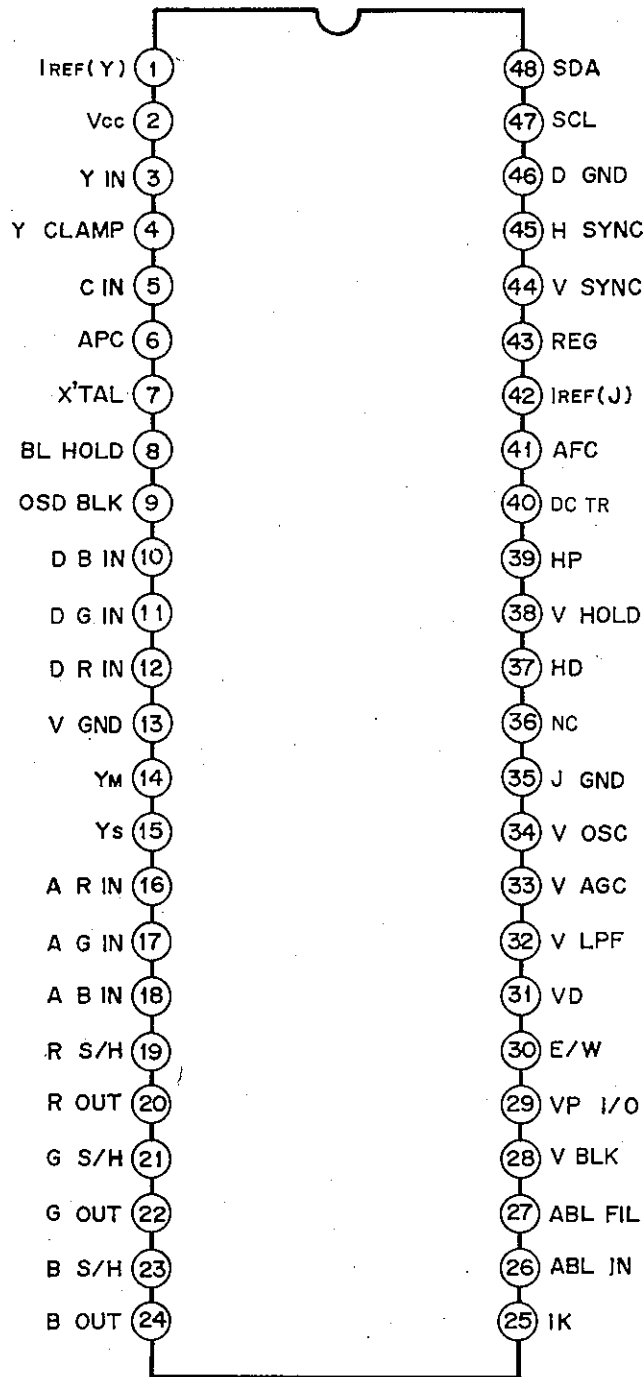

Pin Description

(Pin voltage  $V_{cc}=9V$ )

Pin No.	Symbol	Pin Voltage	Equivalent Circuit	Description
1	$I_{REF}(Y)$	6.4V		Connected to Pin 43 with a resistor in between to produce Y system reference current
2	$V_{cc}$	9V		Power supply pin
3	Y IN	5V		Y signal input pin. The specified level is 2Vp-p. To be input via a capacitor.
4	Y CLAMP	6V		Y clamp capacitor pin
5	C IN	—		C signal input pin. Specified input levels (chroma burst) Internal TOT OFF 200mVp-p Internal TOT ON 500mVp-p
6	APC	5V		APC lag-lead filter CR connection pin
7	X'TAL	2.6V		Used with a 3.58MHz X'tal connected

Pin No.	Symbol	Pin Voltage	Equivalent Circuit	Description
8	BL HOLD	4V		Pin for connection of capacitor for holding black peak level of dynamic picture (auto pedestal).
9	OSD BLK	—		OSD BLK signal input pin for digital R, G and B inputs
10 11 12	DB IN DG IN DR IN	—		Digital R, G and B input pins for screen display
13	V GND	—		Video system (Y/C/RGB) GND pin
14 15	$Y_M$ $Y_S$	—		$Y_M/Y_S$ input pins for analog R, G and B inputs $V_{IL}$ max. = 0.4V $V_{IH}$ min. = 1.0V
16 17 18	AR IN AG IN AB IN	5V		Analog R, G and B input pins. To be input via a capacitor. Specified input level 0.7Vp-p (without sync)
19 21 23	R S/H G S/H B S/H	—		Sample hold pins to connect capacitors to GND for auto cut-off of R, G and B
20 22 24	R OUT G OUT B OUT	—		R, G and B output pins

Pin No.	Symbol	Pin Voltage	Equivalent Circuit	Description
25	$I_K$	—		Signal which is beam current ( $I_K$ ) of CRT converted into voltage is to be input via capacitor.
26	ABL IN	—		ABL voltage input pin
27	ABL FIL	—		Connect capacitor for forming LPF for ABL voltage input signal.
28	V BLK	—		V blanking pulse output pin
29	VP I/O	—		V pulse input and output pin
30 31	E/W VD	— —		E/W=Parabolic wave output pin V/D=V drive output pin
32	V LPF	4.2V		Connect capacitor for forming LPF for AGC voltage of V
33 34	V AGC V OSC	—		VAGC is integrating capacitor pin for producing AGCed saw-tooth wave of V. VOSC is integrating capacitor pin for producing saw-tooth wave of V

Pin No.	Symbol	Pin Voltage	Equivalent Circuit	Description
35	J GND	—		GND pin for jungle system (H/V/picture distortion correction)
36	NC	—		No Function
37	HD	—		H drive output pin. This pin is output at open collector.
38	V HOLD	1V		Peak hold pin for sync separation of V. Capacitor to be connected.
39	HP	3V (when there is no signal)		H pulse input pin.
40	DC TR	—		Varies the DC transmission rate. It can be varied between 84 and 100% by changing the voltage applied to pin 40.
41	AFC	2.9V		AFC lag-lead filter CR connection pin.
42	I <sub>REF(J)</sub>	3.8V		Connected to Pin 43 with a resistor in between to produce jungle system reference current.
43	REG	7.7V		Regulator pin for voltage internally produced from V <sub>CC</sub> in IC. Capacitor is connected for stabilization.

Pin No.	Symbol	Pin Voltage	Equivalent Circuit	Description
44	V SYNC	1.4V (when there is no signal)		V sync separation input pin. Video signal is input at 2Vp-p.
45	H SYNC	1.4V (when there is no signal)		H sync separation input pin. Video signal is input at 2Vp-p.
46	D GND	—		Digital system GND pin
47	SCL	—		I <sup>2</sup> C bus standard SCL (Serial CLock) input pin. V <sub>IL</sub> max.=1.5V V <sub>IH</sub> min.=3.0V
48	SDA	—		I <sup>2</sup> C bus standard SDA (Serial DAta) input and output pin. V <sub>IL</sub> max.=1.5V V <sub>IH</sub> min.=3.0V V <sub>OL</sub> max.=0.4V



**Electrical Characteristics**

Setting conditions

- Ta=25°C V<sub>CC</sub>=9V
- I<sup>2</sup>C bus register should be set at "Test Method, I<sup>2</sup>C Bus Register Initial Setting" before test.

No.	Item	Symbol	Test circuit	Condition	Test pin	Test contents	Min.	Typ.	Max.	Unit
1	Regulator voltage	V <sub>REG</sub>	I		43	Pin voltage test	7.5	7.75	8.0	V
2	Current consumption	I <sub>CC</sub>	I		2	Pin inflow current test	65	90	115	mA
3	ABL threshold voltage	V <sub>ABL</sub>	I		27	Voltage at Pin 26 slowly raised to find voltage that causes voltage at Pin 27 to decrease to less than 6v	0.95	1.05	1.15	V

**H system items**

4	Horizontal oscillation variable range 1	f <sub>H</sub> min 1	2	Pin 40: 0V HFREQ: 7F <sub>H</sub>	37	Frequency test	—	14	15.4	kHz
5	Horizontal oscillation variable range 2	f <sub>H</sub> max 1	2	Pin 40: 0V HFREQ: 00H	37	Frequency test	16	17	—	kHz
6	HCENT operation	Δf <sub>HCENT</sub>	2	Video In: Sig-H1 ALIGN: 1	37	HFREQ continuously incremented by +1, beginning at 0, until IC status register HCENT changes from 1 to 0	—	—	—	—
				AFC: 3		(Frequency test) -15.734KHz	-50	0	50	Hz
7	Horizontal sync Pull-in range	Δf <sub>HP-</sub>	2	Video In: Sig-H2, H3	37	To check that IC status register HLOCKN is caused to be 1 (pull-in range F <sub>H</sub> is shifted from 15.734kHz)	-1.2	-0.9	-0.65	kHz
8		Δf <sub>HP+</sub>	2	Video In: Sig-H4, H5			0.62	0.9	1.2	kHz
9	AFC gain 1	AFC <sub>MID</sub>	2	Video In: Sig-H6 AFC: 0	39	Time from fall of Video In to rise at Pin 39: t <sub>-</sub>	—	—	—	—
				Video In: Sig-H7 AFC: 0		Time from fall of Video In to rise at Pin 39: t <sub>+</sub> , t <sub>+</sub> -t <sub>-</sub>	0.5	0.6	0.7	μs
10	AFC gain 2	AFC <sub>LOW</sub>	2	Video In: Sig-H6 AFC: 1	39	Time from fall of Video In to rise at Pin 39: t <sub>-</sub>	—	—	—	—
				Video In: Sig-H7 AFC: 1		Time from fall of Video In to rise at Pn 39: t <sub>+</sub> , t <sub>+</sub> -t <sub>-</sub>	0.7	0.85	1.1	μs
11	AFC gain 3	AFC <sub>HIGH</sub>	2	Video In: Sig-H6 AFC: 2	39	Time from fall of Video In to rise at Pin 39: t <sub>-</sub>	—	—	—	—
				Video In: Sig-H7 AFC: 2		Time from fall of Video In to rise at Pin 39: t <sub>+</sub> , t <sub>+</sub> -t <sub>-</sub>	0.25	0.4	0.5	μs
12	HD output pulse width	HDW	2	Video In Sig-H1	37		23	24.5	26	μs
13	HD output high level	V <sub>HDH</sub>					8.5	9	9.2	V
14	HD output low level	V <sub>HDL</sub>					0.8	1.05	1.5	V



No.	Item	Symbol	Test circuit	Condition	Test pin	Test contents	Min.	Typ.	Max.	Unit	
15	Horizontal phase operating range 1	$H_{PHAC}$	2	Video In: Sig-Y1 HPHASE: 7	24 39	<p>Time difference between BOUT center at Pin 24 and HP center at Pin 39 (BOUT)-(HP)</p>	-0.2	0.10	0.3	$\mu s$	
16	Horizontal phase operating range 2	$H_{PHAL}$		Video In Sig-Y1 HPHASE: 0			-2.6	-2.2	-1.9	$\mu s$	
17	Horizontal phase operating range 3	$H_{PHAR}$		Video In: Sig-Y1 HPHASE: $F_H$			2.4	2.7	3.0	$\mu s$	
18	Video horizontal blanking width	$P_{ICBLKW}$	2	Video In: Sig-Y1	24		9	9.6	10	$\mu s$	
19	Video horizontal blanking phase	$P_{ICBLKD}$					Phase difference between video center and blanking center (Video)-(BLK)	-250	0	250	ns
20	HP blanking delay time	$t_{DBLK1}$						0	100	200	ns
21	HP blanking delay time	$t_{DBLK2}$						0	100	200	ns

V system items



22	Vertical oscillation variable range 1	$f_{V \text{ min } 1}$	I	VFREQ: $1F_H$	29	Frequency test	-	45	50	Hz
23	Vertical oscillation variable range 2	$f_{V \text{ max } 2}$	I	VFREQ: 0	29	Frequency test	60	65	-	Hz
24	Vertical pull-in range 1	$f_{VP1}$	I	Video In Sig-V1, 2	29	Frequency pulled when frequency of V of Video In signal is made higher than 55Hz. Synchronized with 63Hz but not with 69Hz.	60	66	70	Hz
25	Vertical oscillation variable range 3	$f_{V \text{ min } 2}$	I	VSMO: 1 VFREQ: $1F_H$		Frequency test	-	37	42	Hz
26	Vertical oscillation variable range 4	$f_{V \text{ max } 2}$	I	VSMO: 1 VFREQ: 0		Frequency test	48	53	-	Hz
27	Vertical pull-in range 2	$f_{VP2}$	I	VSMO: 1	29	Adjust VFREQ so that frequency at Pin 29 will be 15Hz.	-	-	-	-
				VSMO: 1 Video In: Sig-V3, V4		Frequency pulled when frequency of V of Video In signal is made higher than 45Hz. Synchronized with 73Hz but not with 79Hz.	70	76	80	Hz
28	VP I/O low level	$V_{LPIO}$	I	Video In: Sig-V5	29		0	0.1	0.4	V
29	VP I/O high level	$V_{HVPIO}$					4.0	5.0	5.5	V
30	VP I/O delay time	$t_{DVPIO}$					0	20	30	$\mu s$
31	V BLK low level	$V_{LVBLK}$	I	Video In: Sig-V5	28		0	0.1	0.4	V
32	V BLK high level	$V_{HVBLK}$					4.0	4.6	5.5	V
33	V BLK delay time	$t_{DVBLK}$					0	20	30	$\mu s$
34	RGBD blanking put-off time	$t_{DRGB}$	I	Video In: Sig-V5	20 22 24	<p>* Reference pulse for picture distortion correction</p>	0	20	30	$\mu s$

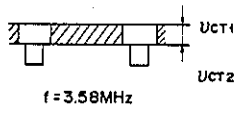
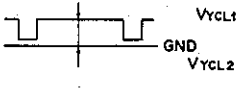
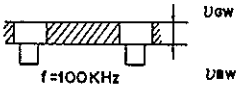
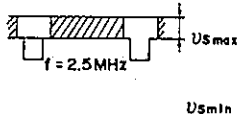
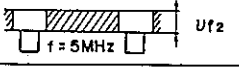
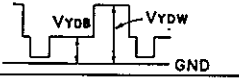
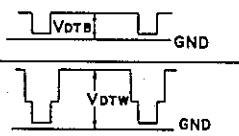
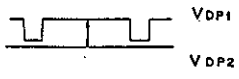
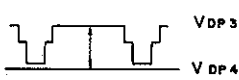

Y system items

No.	Item	Symbol	Test circuit	Condition	Test pin	Test contents	Min.	Typ.	Max.	Unit	
54	Chroma trap attenuation	ATTf <sub>RAP</sub>	2	Video In: Sig-Y5 OFFCT: 0 SHARPNESS: F <sub>H</sub>	20	 f=3.58MHz	$20 \log \frac{V_{CT2}}{V_{CT1}}$	-	-36	-25	dB
				Video In: Sig-Y5 SHARPNESS: F <sub>H</sub>							
55	Y clamp range	ΔV <sub>YCL</sub>	2	Video In: Sig-HI Pin 3: 6V	20	 VYCL1 GND VYCL2	$V_{YCL2} - V_{YCL1}$	-30	-4	20	mV
				Video In: Sig-HI Pin 3: 4V							
56	R output gain	G <sub>RW</sub>	2	Video In: Sig-Y2	20	 f=100KHz	$20 \log \frac{V_{RW}}{0.4}$	6	8.5	11	dB
57	G output gain deviation	ΔG <sub>RG</sub>	2	Video In: Sig-Y2	22		$20 \log \frac{V_{GW}}{V_{RW}}$	0.5	1.5	2.5	dB
58	B output gain deviation	ΔG <sub>RB</sub>	2	Video In: Sig-Y2	24		$20 \log \frac{V_{BW}}{V_{RW}}$	0.5	1.5	2.5	dB
59	Picture variable range	ΔG <sub>PIX</sub>	2	Video In: Sig-Y2 PICTURE: 0			$20 \log \frac{V_{PIX}}{V_{RW}}$	-	-26	-18	dB
60	RGB output frequency characteristic 1	Gf <sub>1</sub>	2	Video In: Sig-Y3	20 22 24	 f=2.5MHz	$20 \log \frac{V_{f1}}{V_W}$ V <sub>W</sub> = V <sub>RW</sub> , V <sub>GW</sub> , V <sub>BW</sub>	1	3	5	dB
61	Sharpness control 1	G <sub>S</sub> max	2	Video In: Sig-Y3 SHARPNESS: F <sub>H</sub>	20		$20 \log \frac{V_{S \text{ MAX}}}{V_{RW}}$	6	7.5	9	dB
62	Sharpness control 2	G <sub>S</sub> min	2	Video In: Sig-Y3 SHARPNESS: 0	20		$20 \log \frac{V_{S \text{ min}}}{V_{RW}}$	-7.5	-5.0	-3	dB
63	R output frequency characteristic 2	Gf <sub>2</sub>	2	Video In: Sig-Y4	20	 f=5MHz	$20 \log \frac{V_{f2}}{V_{RW}}$	-2.5	0	1.5	dB
64	Y dynamic range	ΔG <sub>YDR</sub>	2	Video In: Sig-Y6	20	 VYDB VYDW GND	$20 \log \frac{V_{YDW} - V_{YDB}}{1.43}$ -G <sub>RW</sub>	-2	-0.5	1	dB
65	DC transmission rate	G <sub>DT</sub>	2	Video In: Sig-HI PICTURE: 3F <sub>H</sub>	20	 VDTB GND VDTW GND	$\frac{V_{DTW} - V_{DTB}}{V_{YDW} - V_{YDB}} \times 100$	80	84	88	%
				Video In: Sig-Y7 PICTURE: 3F <sub>H</sub>	20						
66	Black pull-in amount 1	ΔV <sub>DP1</sub>	2	Video In: Sig-HI Pin 8: 3V	20	 VDP1 VDP2	$V_{DP1} - V_{DP2}$	200	300	400	mV
				Video In: Sig-HI Pin 8: 5V							
67	Black pull-in amount 2	ΔV <sub>DP2</sub>	2	Video In: Sig-Y8 Pin 8: 3V	20	 VDP3 VDP4	$V_{DP3} - V_{DP4}$	-5	15	35	mV
				Video In: Sig-Y8 Pin 8: 5V							
68	Black pull-in amount 3	ΔV <sub>DP3</sub>	2	Video In: Sig-HI Pin 8: Voltage source open	20	 VDP5 VDP6	$V_{DP1} - V_{DP5}$	30	60	90	mV
69	Black pull-in amount 4	ΔV <sub>DP3</sub>	2	Video In: Sig-Y9 Pin 8: Voltage source open							

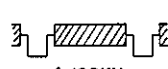
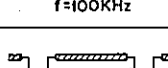
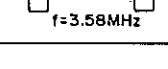
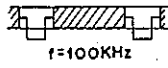
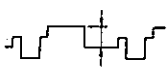
C system items





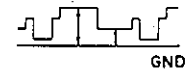
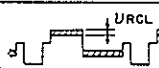
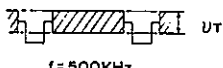
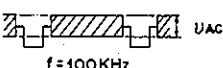

No.	Item	Symbol	Test circuit	Condition	Test pin	Test contents	Min.	Typ.	Max.	Unit	
70	APC pull-in range 1	$f_{APC1}$	2	Video In: Sig-H1 C In: Sig-C1	24	 Pull-in at burst frequency $\pm 350$ Hz	-	-	-350	Hz	
71	APC pull-in range 2	$f_{APC2}$	2	Video In: Sig-H1 C In: Sig-C2	24	 $f=100$ KHz	350	-	-	Hz	
72	Carrier leak	$V_{CL}$	2	Video In: Sig-H1	24	 $f=3.58$ MHz	0	5	50	mVp-p	
73	Color output level	$V_{CC \max}$	2	Video In: Sig-H1 C In: Sig-C3	24	$U_{CC \max}$	0.8	1.1	1.8	Vp-p	
74	Color control characteristic 1	$G_{CC \text{ cent}}$	2	Video In: Sig-H1 C In: Sig-C3 SATURATION: $3F_H$	24	$U_{CC \text{ cent}}$ $20 \log \frac{V_{CC \text{ cent}}}{V_{CC \max}}$	-6	-4.8	-3.0	dB	
75	Color control characteristic 2	$G_{CC \text{ min}}$	2	Video In: Sig-H1 C In: Sig-C3 SATURATION: 0	24	 $f=100$ KHz $U_{CC \text{ min}}$ $20 \log \frac{V_{CC \text{ min}}}{V_{CC \max}}$	-	-55	-40	dB	
76	Chroma picture variable range	$G_{CP}$	2	Video In: Sig-H1 C In: Sig-C3 PICTURE: 0	24	$U_{CP \text{ min}}$ $20 \log \frac{V_{CP \text{ min}}}{V_{CC \max}}$	-	-25	-18	dB	
77	Detection axis R	$\phi_R$	2	Video In: Sig-H1 C In: Sig-C4 PICTURE: $1F_H$	20	 $\Delta V_{R1}$ $\Delta V_{R2}$	$90^\circ - \tan^{-1} \frac{\Delta V_{R2}}{\Delta V_{R1}}$	* 91 (107)	98 (114)	105 (121)	deg
				Video In: Sig-H1 C In: Sig-C5 PICTURE: $1F_H$	20						
78	Detection axis R	$\phi_G$	2	Video In: Sig-H1 C In: Sig-C4 PICTURE: $1F_H$	22	 $\Delta V_{G1}$ $\Delta V_{G2}$	$270^\circ - \tan^{-1} \frac{\Delta V_{G2}}{\Delta V_{G1}}$	* 236 (248)	243 (255)	250 (262)	deg
				Video In: Sig-H1 C In: Sig-C5 PICTURE: $1F_H$	22						
79	Detection output ratio R	$G_R$	2	Video In: Sig-H1 C In: Sig-C3	20	 $U_{RC}$ $\frac{V_{RC}}{V_{CC \max}} \frac{V_{RW}}{V_{RW}}$	0.67	0.78	0.9	-	
80	Detection output ratio G	$G_G$			22	$U_{GC}$ $\frac{V_{GC}}{V_{CC \max}} \frac{V_{RW}}{V_{GW}}$	0.27	0.31	0.36	-	

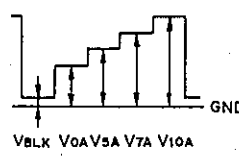
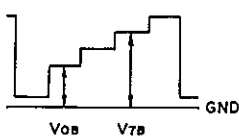

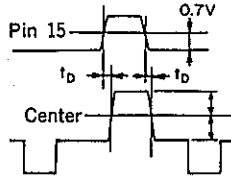
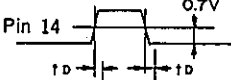
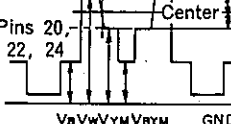
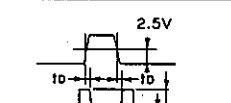
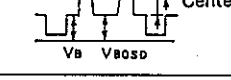
※ The value in brackets is the value of CXA1465AS

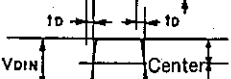
No.	Item	Symbol	Test circuit	Condition	Test pin	Test contents	Min.	Typ.	Max.	Unit
81	HUE variable range 1	$\phi$	2	Video In: Sig-H1 C In: Sig-C4, C5 PICTURE: 1F <sub>H</sub> , HUE: 0	24	 CIn: Sig-C4 Vc1 Vc2 CIn: Sig-C5 Vc3 Vc4	-	-38	-28	deg
82	HUE variable range 2	$\phi_c$	2	Video In: Sig-H1 C In: Sig-C4, C5 PICTURE: 1F <sub>H</sub> , HUE: 3F <sub>H</sub>			0	9	18	deg
83	HUE variable range 3	$\phi_+$	2	Video In: Sig-H1 C In: Sig-C4, C5 PICTURE: 1F <sub>H</sub> , HUE: 7F <sub>H</sub>			42	48	-	deg
84	Residual carrier level	V <sub>RCL</sub>	2	Video In: Sig-H1 C In: Sig-C4	24	 3.58MHz component +7.16MHz component	0	10	100	mVp-p
85	Chroma frequency characteristic -	G <sub>T-</sub>	2	Video In: Sig-H1 C In: Sig-C6 (-500KHz)	 f=500KHz	$20 \log \frac{V_T}{V_{CC \max}}$	-9	-4	0	dB
86	Chroma frequency characteristic +	G <sub>T+</sub>	2	Video In: Sig-H1 C In: Sig-C7 (+500KHz)			-3.5	-1.5	0.5	dB
87	Chroma frequency characteristic 2	G <sub>TOFF</sub>	2	Video In: Sig-H1 C In: Sig-C6 OFFTOT: 1			-3.5	-1.5	0.5	dB
88	ACC amplitude characteristic +	G <sub>ACC+</sub>	2	Video In: Sig-H1 C In: Sig-C8 (+6dB)	 f=100KHz	$20 \log \frac{V_{ACC}}{V_{CC \max}}$	-0.5	0.2	1.5	dB
89	ACC amplitude characteristic -	G <sub>ACC-</sub>	2	Video In: Sig-H1 C In: Sig-C9 (-20dB)			-8	-1.2	0	dB
90	Killer point	KP	2	Video In: Sig-H1 C In: Sig-C10, C11			Check that output ceases to appear at -41dB and appears at -24dB.	-41	-30	-24

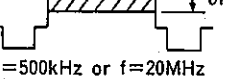
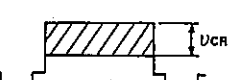
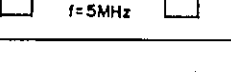
RGB interface system items

No.	Item	Symbol	Test circuit	Condition	Test pin	Test contents	Min.	Typ.	Max.	Unit	
91	A-IN gain 1	G <sub>AIN</sub>	2	RGBPIX : 7F <sub>H</sub>  Video In: Sig-H1 Ain: Sig-R1 Pin 15: 1.4V	20 22 24	 VBLK V0AV5A V7A V10A	$20 \log \frac{V_{7A} - V_{0A}}{0.7}$	9	10	11	dB
92	A-IN linearity	L <sub>EXT</sub>	2				$\frac{V_{10A} - V_{0A}}{2(V_{5A} - V_{0A})} \times 100$	95	98	100	%
93	A-IN gain deviation	$\Delta G_{AIN}$	2				1.1	1.7	2.3	dB	
94	Blanking level	V <sub>BLK</sub>	2				V <sub>BLK</sub>	0	0.25	0.4	V
95	A-IN gain 2	G <sub>PIX</sub>	2	RGBPIX: 0	20 22 24	$20 \log \frac{V_{7R} - V_{0R}}{0.7}$	-14.5	-13.5	-12	dB	
96	Drive variable range	G <sub>DRIVE</sub>	2	GAMP: 0 BAMP: 0	22 24	$20 \log \frac{V_{7R} - V_{0R}}{V_{7A} - V_{0A}}$	-6.5	-5.5	-4.5	dB	
97	Dynamic color operation R	D <sub>COLR</sub>	2	DYCOL: 1	20	 V0B V7B	$\frac{V_{7R} - V_{0R}}{V_{7A} - V_{0A}} \times 100$	94.5	97	98.5	%
98	Dynamic color operation G	D <sub>COLG</sub>	2		22			98	100	102	%
99	Dynamic color operation B	D <sub>COLB</sub>	2		24			104	106	108	%
100	Dynamic color off-set	$\Delta V_{DCOL}$	2		20 22 24			V <sub>0B</sub> - V <sub>0A</sub>	-30	0	30

No.	Item	Symbol	Test circuit	Condition	Test pin	Test contents	Min.	Typ.	Max.	Unit		
101	Ys delay time	$t_{DYS}$	2	Video In: Sig-H1 A In: Sig-R2 Pin 15: SIG-R3	20 22 24		$t_D$	0	50	70	ns	
102	$Y_M$ delay time	$t_{DYS}$	2	Video In: Sig-Y10 Pin 15: SIG-R3	20 22 24		$t_D$	0	30	70	ns	
103	$Y_M$ attenuation	$G_{YM}$					$20 \log \frac{V_{YM} - V_B}{V_W - V_B}$	-6.4	-5.4	-4.4	dB	
104	$Y_M$ Black variation	$\Delta V_{YM}$					$V_B - V_{BYM}$	-30	25	120	mV	
105	OSDBLK delay time	$t_{DOSD}$	2	Video In: Sig-H1 A In: Sig-R5 Pin 9: Sig-R7	20 22 24		$t_D$	0	40	70	ns	
106	OSDBLK black variation	$\Delta V_{OSD}$					$V_B - V_{BOSD}$	-150	130	400	mV	
107	DIN delay time	$t_{DDIN}$	2	Video In: Sig-H1 D In: Sig-R6	20 22 24		$t_D$	0	30	70	ns	
108	DIN level H.	$V_{DH}$	2		DRGBP: 0	20 22 24		$V_{DIN}$	1.55	1.8	2.05	V
109	DIN level L	$V_{DL}$	2		DRGBP: 1	20 22 24		$V_{DIN}$	1.25	1.45	1.65	
110	AIN frequency characteristic	$G_{FREQ}$	2		Video In: Sig-H1 A In: Sig-R7, R8 (R7: 500KHz, R8: 20MHz)	20 22 24		$20 \log \frac{v_f(20M)}{v_f(500K)}$	-5	-3	0	dB
111	Crosstalk 1	$G_{CROS1}$	2	Video In: Sig-Y14 Pin 15: 0V/1.4V	20 22 24		$20 \log \frac{v_{CR}(1.4V)}{v_{CR}(0V)}$	-	-60	-50	dB	
112	Crosstalk 2	$G_{CROS1}$	2	Video In: Sig-H1 A In: Sig-R9 Pin 15: 0V/1.4V	20 22 24		$20 \log \frac{v_{CR}(0V)}{v_{CR}(1.4V)}$	-	-60	-50	dB	

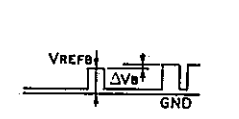
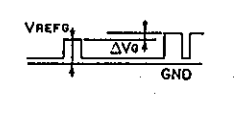
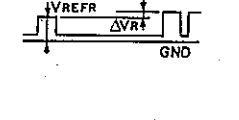
No.	Item	Symbol	Test circuit	Condition	Test pin	Test contents	Min.	Typ.	Max.	Unit		
113	ABL operation 1	$G_{ABL11}$	2	BRIGHTNESS: $7F_H$ BLM: 1 Video In: Sig-Y10 Pin 27: 8V/5V/2V	20		$20 \log \frac{V_{WA2} - V_{BA2}}{V_{WA1} - V_{BA1}}$	-	-10	-6	dB	
114	ABL operation 2	$V_{ABL11}$					$V_{BA2} - V_{BA1}$	-50	0	50	mV	
115	ABL operation 3	$G_{ABL12}$					$20 \log \frac{V_{WA3} - V_{BA3}}{V_{WA1} - V_{BA1}}$	-	-42	-19	dB	
116	ABL operation 4	$V_{ABL12}$					$V_{BA3} - V_{BA1}$	-	-1.4	-1.0	V	
117	ABL operation 5	$G_{ABL2}$	2	BRIGHTNESS: $7F_H$ BLM: 0 Video In: Sig-Y10 Pin 27: 8V/5V	20	<p>Pin 27 8V <math>V_{BA1}</math> <math>V_{WA1}</math> Pin 27 5V <math>V_{BA2}</math> <math>V_{WA2}</math> Pin 27 2V <math>V_{BA3}</math> <math>V_{WA3}</math></p> 	$20 \log \frac{V_{WA2} - V_{BA2}}{V_{WA1} - V_{BA1}}$	-	-3	-1.5	dB	
118	ABL operation 6	$V_{ABL2}$					$V_{BA2} - V_{BA1}$	-	-0.5	-0.4	V	
119	A-IN ABL operation 1	$G_{ABL31}$	2	BRIGHTNESS: $7F_H$ BLM: 1 Video In: Sig-H1 A In: Sig-R1 Pin 27: 8V/5V/2V	20		$20 \log \frac{V_{TA2} - V_{OA2}}{V_{TA1} - V_{OA1}}$	-	-8	-4.5	dB	
120	A-IN ABL operation 2	$V_{ABL31}$					$V_{OA2} - V_{OA1}$	-50	0	50	mV	
121	A-IN $G_{ABL32}$ operation 3	$G_{ABL32}$					$20 \log \frac{V_{TA3} - V_{OA3}}{V_{TA1} - V_{OA1}}$	-	-18	-8	dB	
122	A-IN ABL operation 4	$V_{ABL32}$					$V_{OA3} - V_{OA1}$	-	-1.4	-1.1	V	
123	$I_K$ clamp level	$V_{CLAMP}$	3	Video In: Sig-V5 Pin 15: 1.4V	25		$V_{CLAMP}$	1.25	1.35	1.45	V	
124	$I_K R$ level	$V_{IKR}$					$V_{IKR}$	2.15	2.25	2.35	V	
125	$I_K$ variable range 1	$V_{IK \max}$					GCUT OFF: $F_H$ BCUT OFF: $F_H$	$V_{IKG} \cdot V_{IKB}$	2.45	2.55	2.65	V
126	$I_K$ variable range 2	$V_{IK \min}$						GCUT OFF: 0 BCUT OFF: 0	$V_{IKG} \cdot V_{IKB}$	1.55	1.65	1.75
127	RGB output DC range 1	$V_{REF \max}$	1	Video in: Sig-V5 Pin 15: 1.4V $V_{SH}$ : 4.6V	20 22 24		$V_{REFR1}$ $V_{REFG1}$ $V_{REFB}$	3.0	3.3	3.7	V	
128	RGB output DC range 2	$V_{REF \min}$					Video in: Sig-V5 Pin 15: 1.4V $V_{SH}$ : 8V	$\Delta V_{R1}$ $\Delta V_{G1}$ $\Delta V_{R}$	0.5	0.85	1.3	V
129	BRIGHT variable range 1	$V_{BRT \min}$					BRIGHTNESS: 0	$\Delta V_{R1}$ $\Delta V_{G1}$ $\Delta V_{R}$	-1.4	-1.0	-0.8	V
130	BRIGHT variable range 2	$V_{BRT \max}$					BRIGHTNESS: $7F_H$	$\Delta V_{R1}$ $\Delta V_{G1}$ $\Delta V_{R}$	0.24	0.3	0.41	V
131	A-IN DC offset	$\Delta V_{AIN}$	1	BRIGHTNESS: Adjustment Video In: Sig-V5 Pin 15: 1.4V	20 22 24		First adjust BRIGHTNESS to reduce $\Delta V_R$ to a minimum. Offset voltage between Pins 20, 22 and 24 ( $\Delta V_{R1}$ $\Delta V_{G1}$ $\Delta V_{R}$ )	-30	0	30	mV	
132	Y-IN DC offset	$\Delta V_{YIN}$	1	BRIGHTNESS: Adjustment Video In: Sig-V5			First adjust BRIGHTNESS to reduce $\Delta V_R$ to a minimum. Offset voltage between Pins 20, 22 and 24 ( $\Delta V_{R1}$ $\Delta V_{G1}$ $\Delta V_{R}$ )	-30	0	30	mV	



I<sup>2</sup>C Bus Items (SDA, SCL)

No.	Item	Symbol	Min.	Typ.	Max.	Unit
133	High level input voltage	V <sub>IH</sub>	3.0	—	5.0	V
134	Low level input voltage	V <sub>IL</sub>	0	—	1.5	V
135	High level input voltage	I <sub>IH</sub>	—	—	10	μA
136	Low level input voltage	I <sub>IL</sub>	—	—	10	μA
137	Low level output voltage (during SDA (Pin 48) 3mA inflow)	V <sub>OL</sub>	0	—	0.4	V
138	Maximum inflow current	I <sub>OL</sub>	3	—	—	mA
139	Input capacitance	C <sub>I</sub>	—	—	10	pF
140	Maximum clock frequency	f <sub>SCL</sub>	0	—	100	kHz
141	Data change minimum waiting time	t <sub>BUF</sub>	4.7	—	—	μs
142	Minimum waiting time at start of data transfer	t <sub>HD:STA</sub>	4.0	—	—	μs
143	Low level clock pulse width	t <sub>LOW</sub>	4.7	—	—	μs
144	High level clock pulse width	t <sub>HIGH</sub>	4.0	—	—	μs
145	Minimum waiting time for start preparation	t <sub>SU:STA</sub>	4.7	—	—	μs
146	Minimum data hold time	t <sub>HD:DAT</sub>	5	—	—	μs
147	Minimum data preparation time	t <sub>SU:DAT</sub>	250	—	—	ns
148	Rise time	t <sub>R</sub>	—	—	1	μs
149	Fall time	t <sub>F</sub>	—	—	300	ns
150	Minimum waiting time for stop preparation	t <sub>SU:STO</sub>	4.7	—	—	μs

I<sup>2</sup>C bus load conditions: Pll up resistor 4kΩ (Connect to +5V)  
Load capacity 200pF (Connect to GND)

I<sup>2</sup>C Bus Control Signal

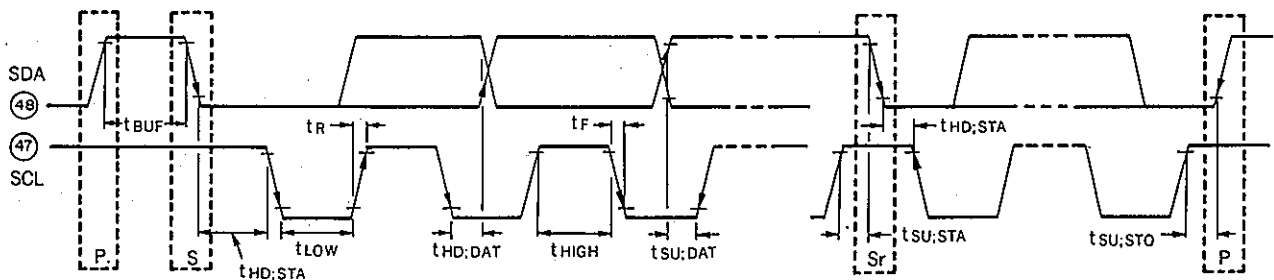

Electrical Characteristics Test Circuit

Test circuit 1

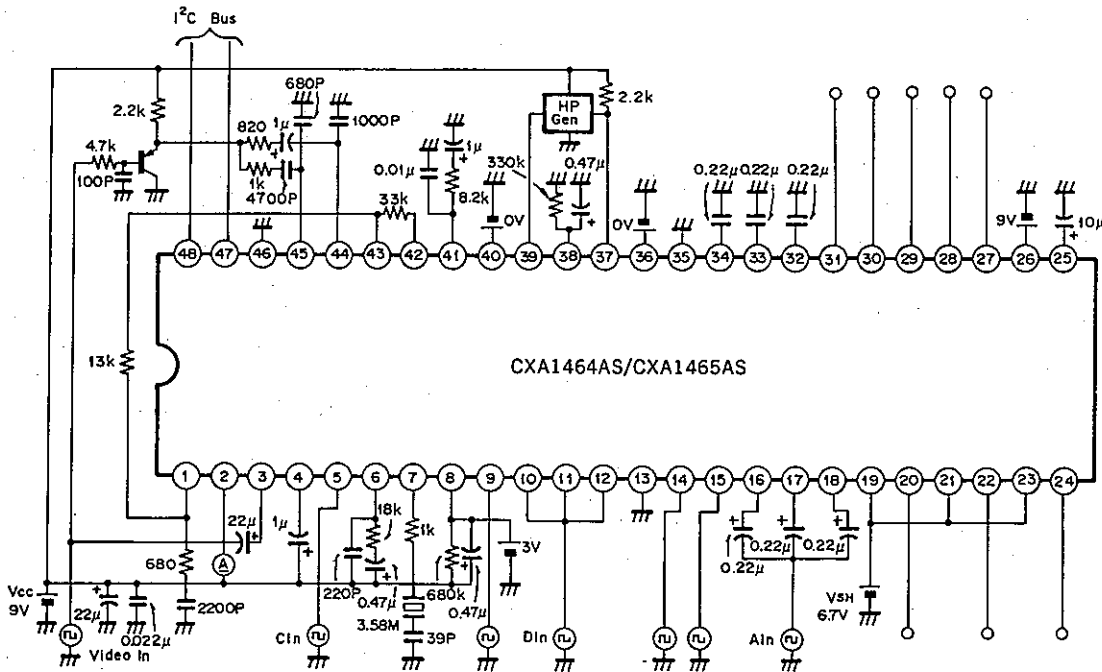

※ All  $\text{Ⓢ}$  except those specified in the "Condition" column of the electrical characteristics should be connected to GND.

Test circuit 2

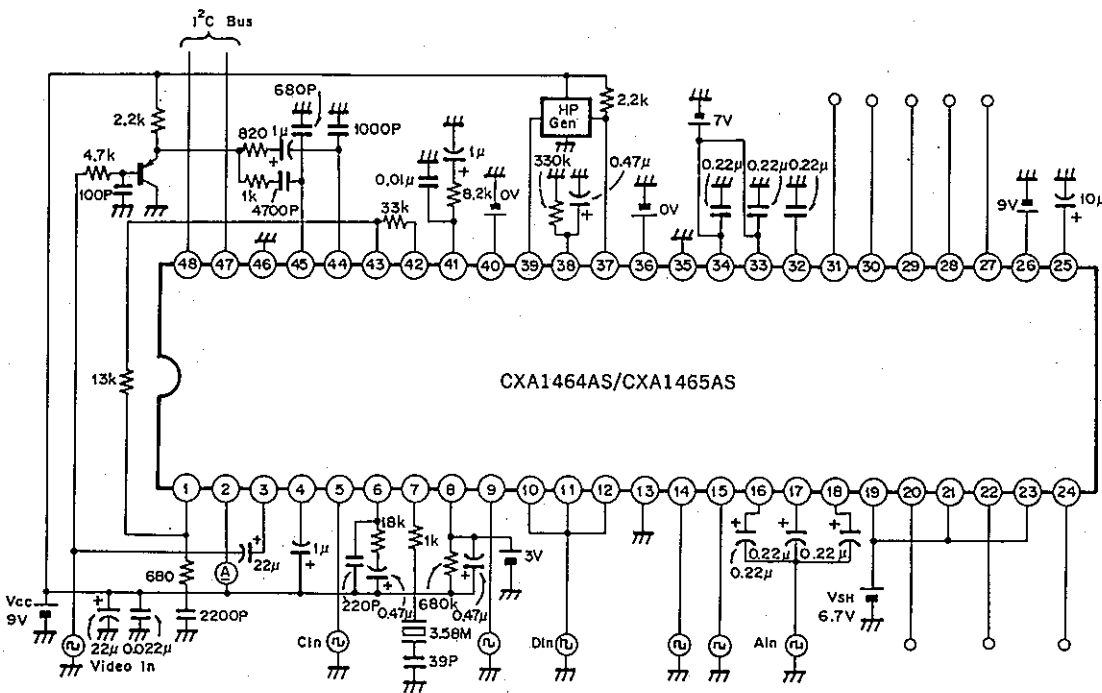

※ All  $\text{Ⓢ}$  except those specified in the "Condition" column of the electrical characteristics should be connected to GND.

Test circuit 3

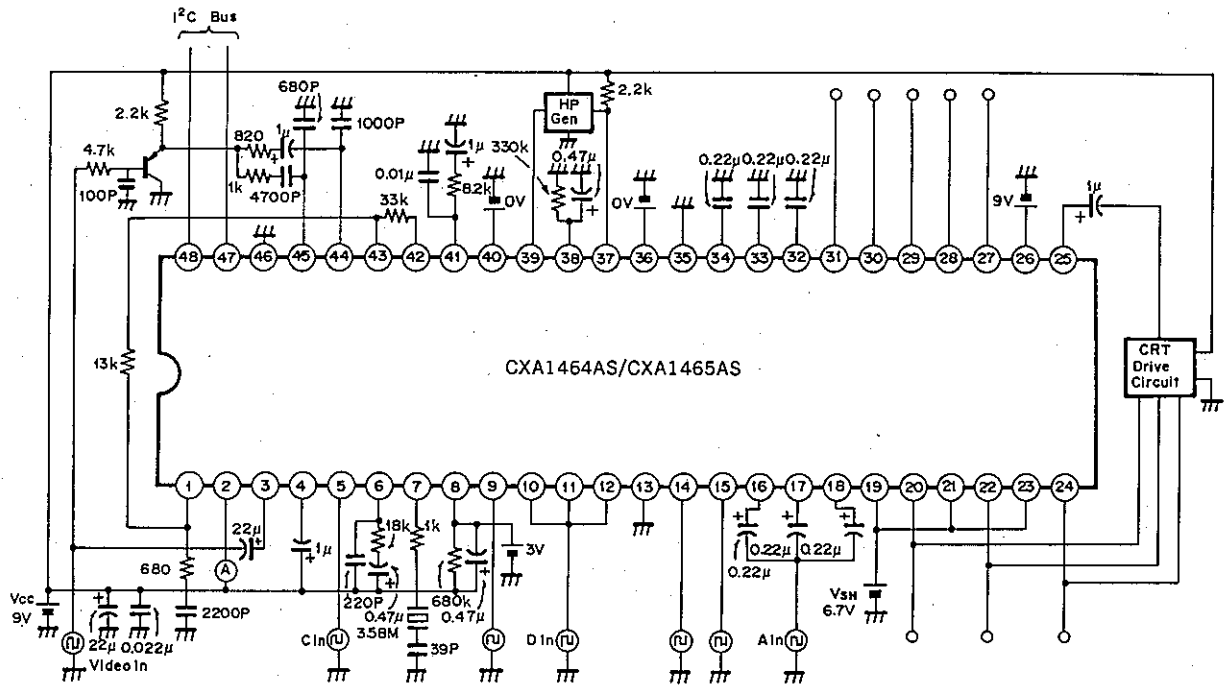

※ All ⊕ except those specified in the "Condition" column of the electrical characteristics should be connected to GND.

Reference Circuit

CRT Drive Circuit

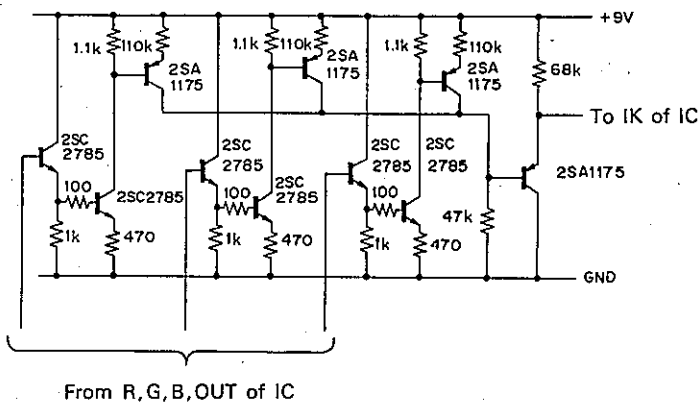

HP Gen.

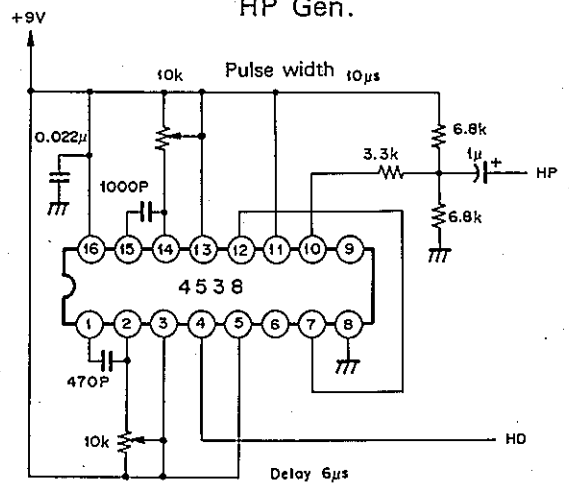

Video Signals Used for Test  
H system test signals

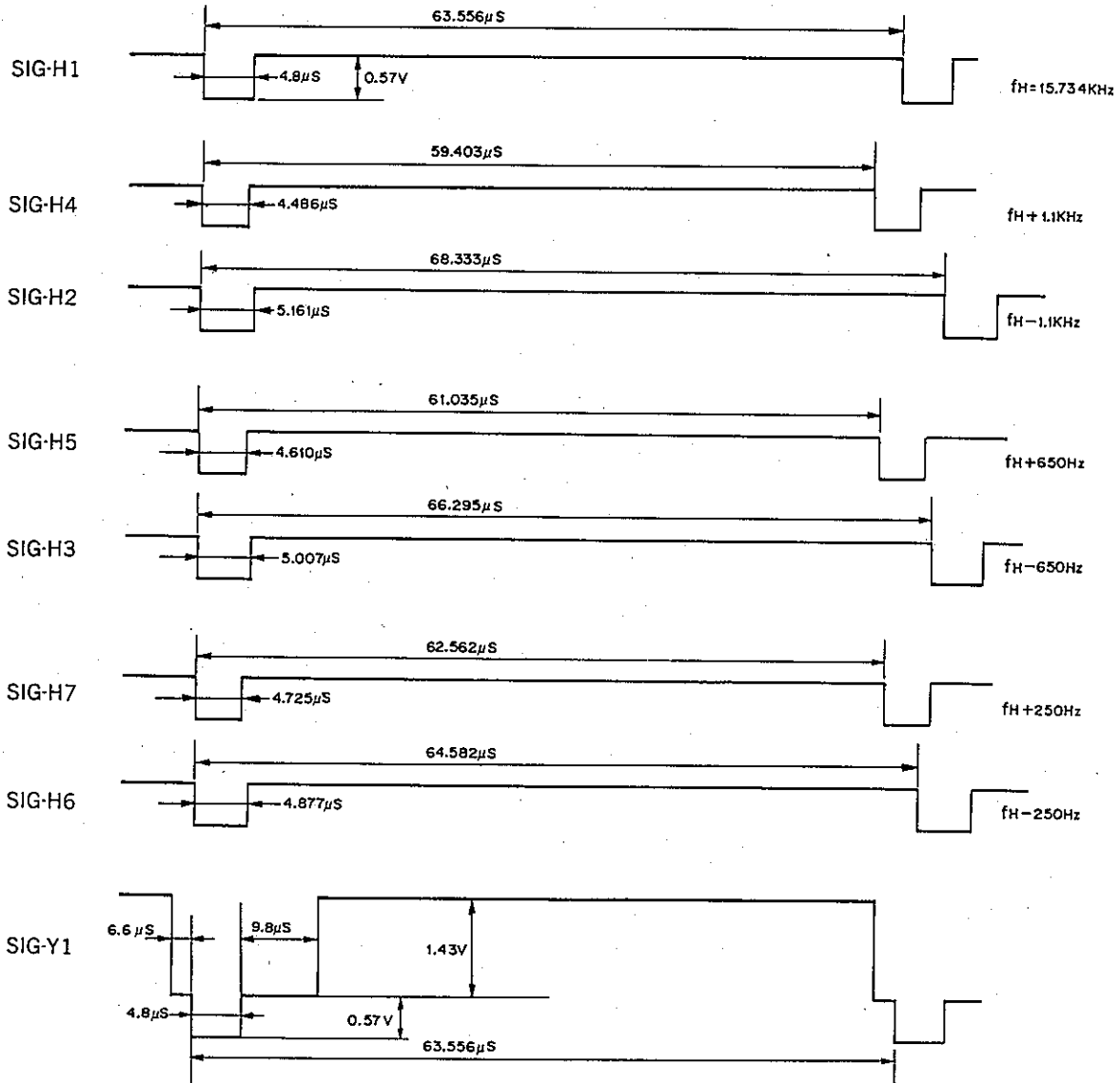

V and Deflection compensation systems test signals

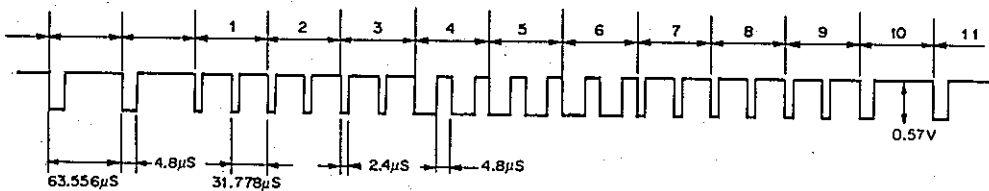

- SIG-V1  $f_V = f_H / 250$       SIG-V4  $f_V = f_H / 199$
- SIG-V2  $f_V = f_H / 228$       SIG-V5  $f_V = f_H / 262$
- SIG-V3  $f_V = f_H / 215.5$

Y system test signals

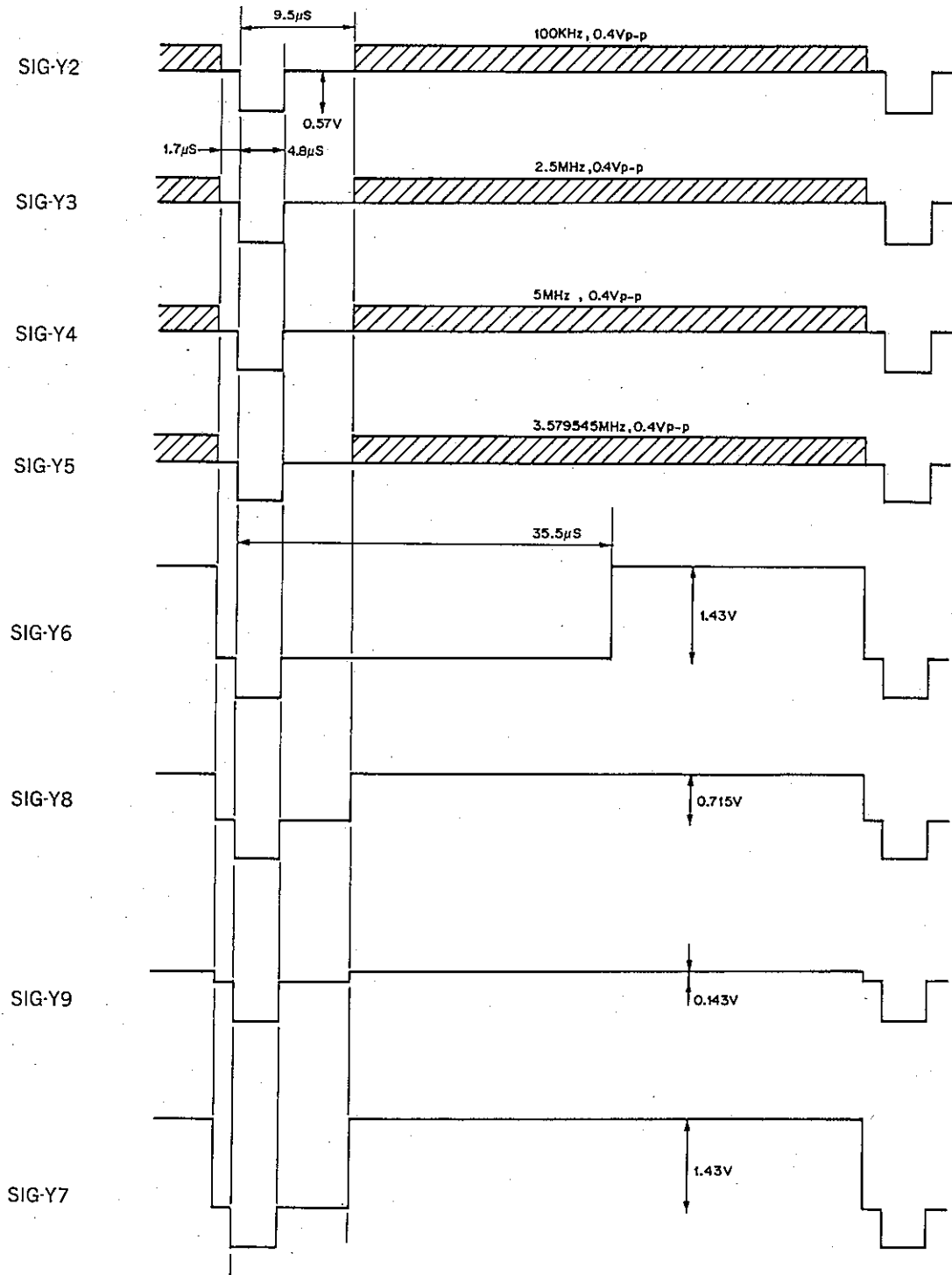

C system test signals  $f_{SC} = 3.579545\text{MHz}$

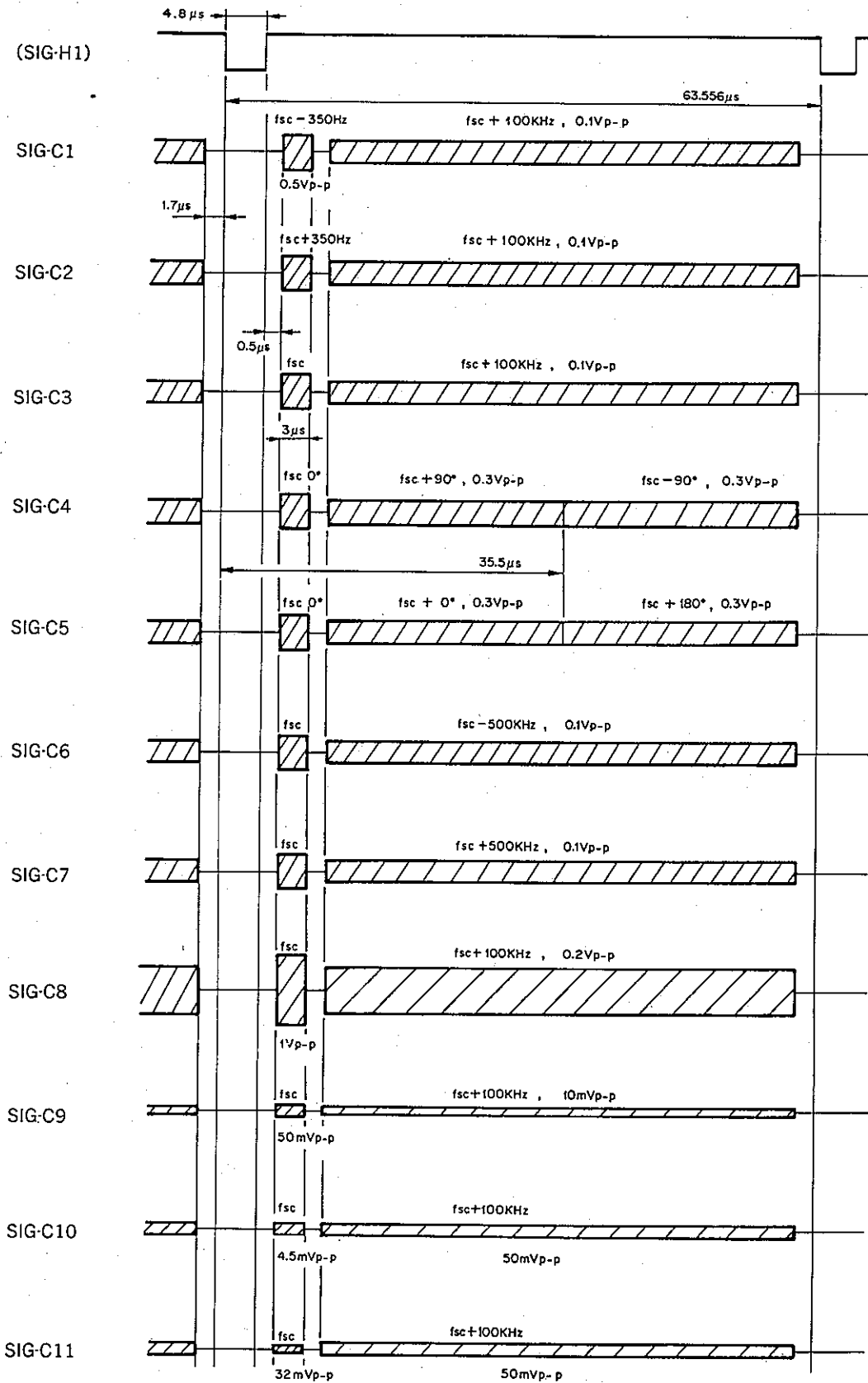

RGB system test signals

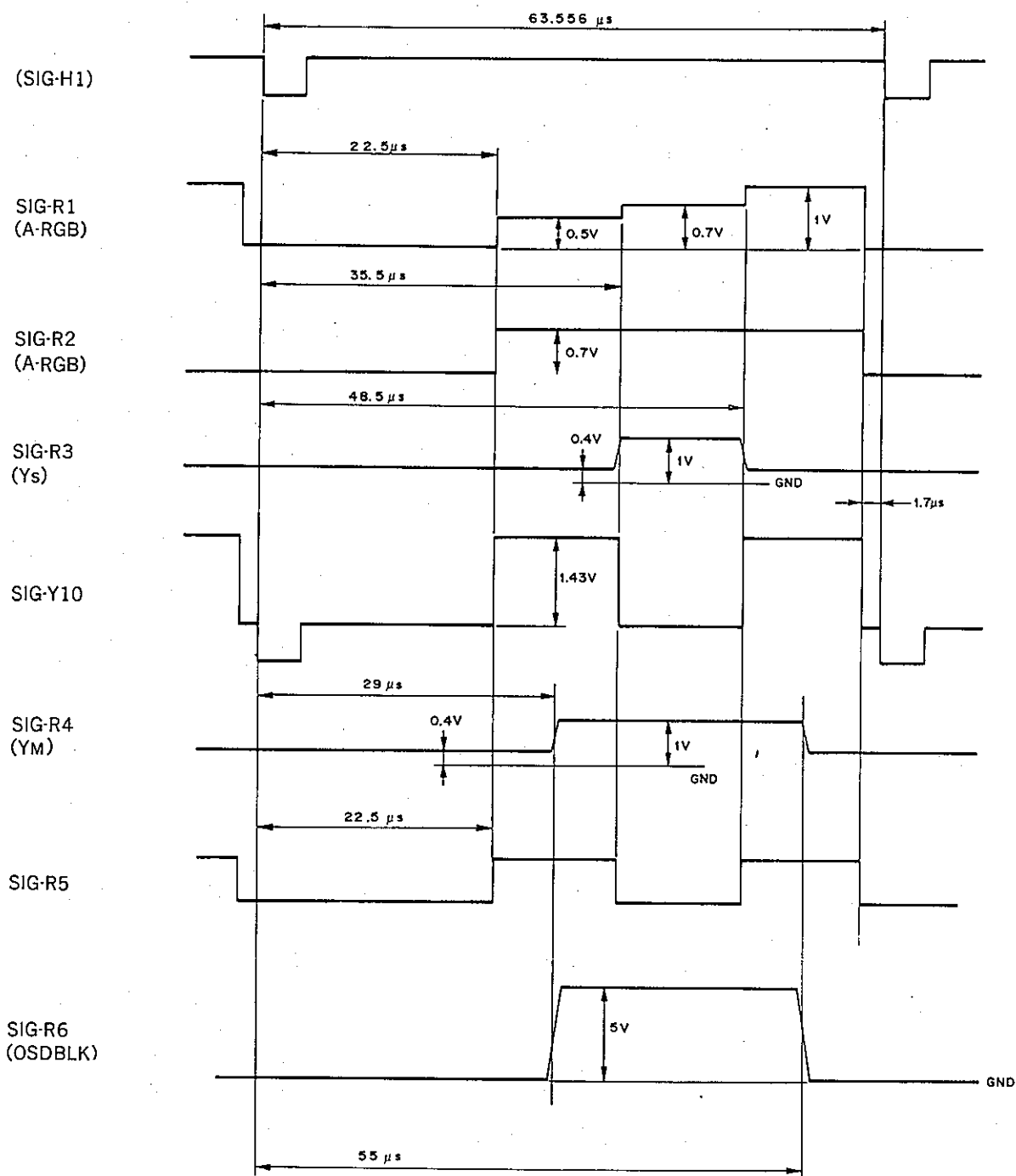

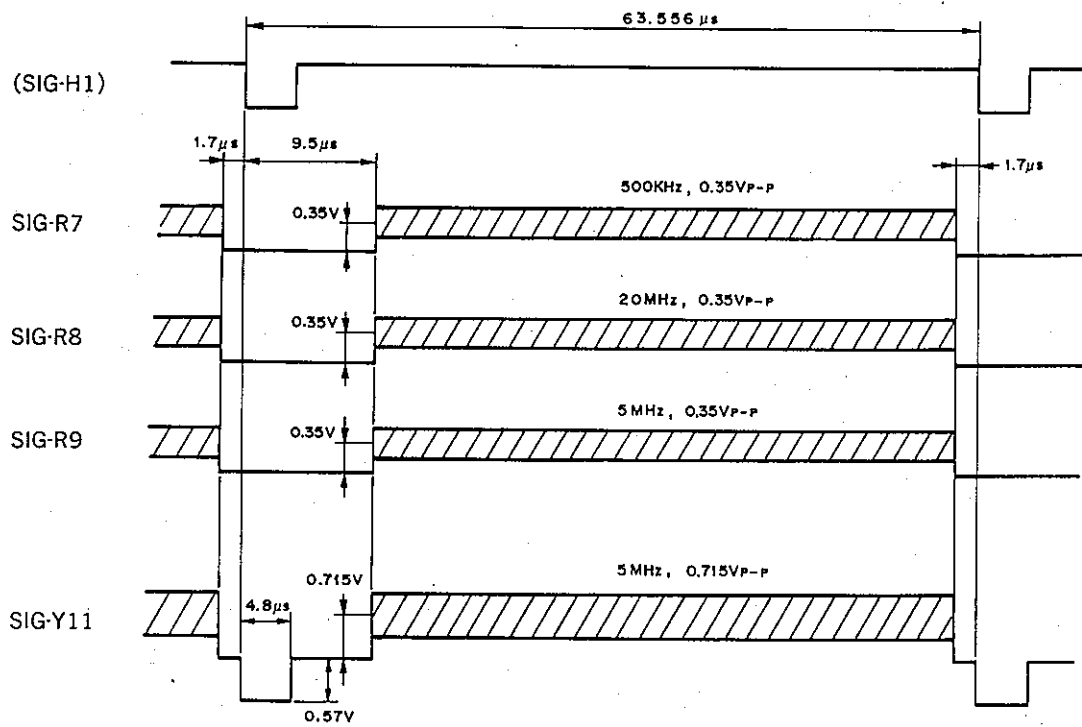



## Test Methods

I<sup>2</sup>C Bus Register Data Initial Settings

Register Name	No. of Bit	Initial Setting	Description	Register Name	No. of Bit	Initial Setting	Description
HFREQ	7	Adjustment point		BAMP	5	1F <sub>H</sub>	Maximum value
PMUTE	1	1 <sub>H</sub>	Canceling picture muting	GCUTOFF	4	F <sub>H</sub>	Maximum value
VFREQ	5	Adjustment point		OFFNR	1	1 <sub>H</sub>	R output ON
VSMO	1	1 <sub>H</sub>	V pull-in 55 to 65Hz	OFFNG	1	1 <sub>H</sub>	G output ON
VTRIG	1	0 <sub>H</sub>	V trigger Pin 44	OFFNB	1	1 <sub>H</sub>	B output ON
VSHIFT	5	F <sub>H</sub>	Center point	BCUTOFF	4	F <sub>H</sub>	Maximum value
OFFNV	1	1 <sub>H</sub>	Delivering VD output	DYCOL	1	0 <sub>H</sub>	New dynamic color OFF
VSIZE	6	1F <sub>H</sub>	Center point	RGB	2	0 <sub>H</sub>	Normal mode
VLIN	4	7 <sub>H</sub>	Center point	CHRTRAP	6	Adjustment point	
VCOMP	3	3 <sub>H</sub>	Center point	OFFCT	1	1 <sub>H</sub>	Chroma trap OFF
HPHASE	4	7 <sub>H</sub>	Center point	PICTURE	7	7F <sub>H</sub>	Maximum value
AFC	2	0 <sub>H</sub>	Loop gain in effect	HUE	7	Adjustment point	
HSIZE	5	F <sub>H</sub>	Center point	SATURATION	7	7F <sub>H</sub>	Maximum value
REF	0	2 <sub>H</sub>	Minimum value	OFFTOT	1	0 <sub>H</sub>	Passed through TOT filter
PINAMP	5	F <sub>H</sub>	Center point	BRIGHTNESS	7	3F <sub>H</sub>	Center point
CORNER PIN	3	3 <sub>H</sub>	Center point	BLM	1	1 <sub>H</sub>	Picture ABL mode
PIN PHASE	4	7 <sub>H</sub>	Center point	SHARPNESS	4	7 <sub>H</sub>	Center point
VS CORR	4	7 <sub>H</sub>	Center point	RGBPIX	7	7F <sub>H</sub>	Maximum value
GAMP	5	1F <sub>H</sub>	Maximum value	DRGBP	1	0 <sub>H</sub>	0dB
ALIGN	1	0 <sub>H</sub>	Ordinary mode	CTL	8	0 <sub>H</sub>	Minimum value

## Adjustment Method

## 1. HFREQ

Set the same condition as for Electrical Characteristics No.5 Horizontal Oscillation Variable Range 1 and adjust HFREQ so that the frequency at Pin 37 will have data closest to 15.734kHz.

## 2. VFREQ

Set the same condition as for Electrical Characteristics No.27 Vertical Oscillation Variable Range 1 and adjust VFREQ so that the frequency at Pin 29 will have data closest to 55Hz.

## 3. CHRTRAP

Set the same condition as for Electrical Characteristics No.59 Chroma Trap Attenuation (OFFCT=0) and adjust CHRTRAP so that  $U_{CT}$  will be reduced to a minimum.

## 4. HUE

Set the same condition as for Electrical Characteristics No.86 HUE Variable Range 1 (Video In: Sig-C4) and adjust HUE so that  $V_{C2-C1}$  will be reduced to a minimum.

## Operation

### 1. Synchronizing and deflection compensation systems

The video signals (2Vp-p standard) input to Pins 44 and 45 are led to the horizontal and vertical sync separator circuits for sync separation. First the horizontal sync signal obtained by the horizontal sync separator circuit is compared with the horizontal oscillation output to detect a phase difference. The error voltage resulting from the phase difference is minimized by the lag-lead filter which attenuates medium and high region components before application to the horizontal oscillator. The horizontal oscillator output is phase shifted to match the phase of the flyback transformer before it is output to Pin 37.

The vertical sync signal obtained by the vertical sync separator circuit is used to trigger the vertical oscillator for synchronization with the input signal. To ensure that the amplitude of the saw-tooth wave output of the vertical oscillator is maintained constant irrespective of the vertical frequency of the input, AGC is achieved before the output is delivered to the picture distortion correction circuit. The picture distortion correction circuit produces vertical saw-tooth wave and parabolic wave which are respectively output to Pins 31 and 32. Note that the horizontal and vertical oscillators require respective free running frequency adjustments.

The burst gate pulse produced by differentiation of the horizontal sync separated signal is supplied to the Y/C system block.

#### [Caution]

- When the Y/C and RGB interface systems are to be tested for evaluation, make sure that the free running frequencies of the horizontal and vertical oscillators are adjusted beforehand.

### 2. Y/C system

The Y signal (specified input level 2Vp-p) input to Pin 3 is passed through the delay line, sharpness control, clamp, dynamic picture and contrast control circuits and is mixed with color difference signal and is passed through the clamp circuit again before it is input to the RGB interface system block. The dynamic picture circuit pulls 50 IRE or lower signals toward the black side so that the black peak hold signal at Pin 8 will be at the pedestal level. Since a built-in chroma trap is provided, video signal can be directly input. The trap frequency should be adjusted by the I<sup>2</sup>C bus register. In this case, the delay amount of the delay line and the peaking frequency of the sharpness control are simultaneously adjusted.

The chroma signal (specified input level, burst 500mVp-p, or video signal 2Vp-p) input from Pin 5 is passed through the TOT, ACC, color control (saturation control), killer circuit, etc., and the burst locked VCO oscillation output is detected as the carrier. The signal is then fed to the matrix circuit for separation of color difference signals R-Y, B-Y and G-Y and fed through the Y/C mix circuit to provide R, G and B outputs.

#### [Caution]

- The chroma trap can be switched between the ON and OFF states. Even when it is to be used in the OFF state, it should first be placed in the ON state and the trap point adjusted to 3.58Hz for adjustment of the delay line, sharpness control, etc.
- The TOT (chroma BPF) can be switched between the ON and OFF states but it should be normally used in the ON state.
- Picture control is achieved for Y signal contrast control and chroma signal color control.

### 3. RGB interface system

Analog R, G and B signals input from Pins 16, 17 and 18 are led through the contrast control and clamp circuits and switched to the R, G and B signals of the Y/C system block. Thereafter, the R, G and B signals from Pins 10, 11 and 12 are added. The signals are then passed through the new dynamic color, brightness control, white balance drive amplifier, auto cut-off DC level shift and blanking control circuits to output R, G and B primary color signals from Pins 20, 22 and 24. The new dynamic color circuit detects the flesh and white colors from the amplitude ratio of R, G and B primary color signals and changes the ratio of the R, G and B outputs so that the color temperature will be higher as the color is closer to white without changing the color temperature of the flesh colored portion. (The circuit can be switched between the ON and OFF states by the I<sup>2</sup>C bus register.) The digital R, G and B signals are mainly used for screen display of channels, etc.

Switchover between the analog R, G and B signals and the R, G and B signals of the Y/C block is made by the I<sup>2</sup>C bus register and signal input to the Y<sub>s</sub> pin at Pin 15. The signal input to the Y<sub>m</sub> pin at Pin 14, is used for half blanking of the R, G and B signals of the Y/C block (approx. -6dB). As for the Y<sub>s</sub>/Y<sub>m</sub> for the digital R, G and B signals, the signal input to the OSDCLK Pin at Pin 9, is used. The attenuation of the R, G and B signals depends on the voltage to be input.

The signal input to Pin 26 is compared with the internal reference voltage and is then integrated by the capacitor connected to Pin 27 for control of picture and brightness. Switchover between the picture ABL mode and the combined picture ABL and brightness ABL mode can be made by the I<sup>2</sup>C bus register.

#### [Caution]

- When the digital R, G and B signals and OSDCLK signal are not to be used, connect Pins 9, 10, 11 and 12 to GND.

#### [About auto cut-off]

For white balance, drive control (R, G and B output gain control) and cut-off control (black side DC level control) are involved. The CXA1312S or CXA1313S uses the I<sup>2</sup>C bus register for drive control. For cut-off control, a loop is formed between the IC and CRT to achieve auto cut-off control. The auto cut-off arrangement makes it possible to compensate for the change of the CRT with time. To absorb the variability of the CRT, the G and B outputs are led to the I<sup>2</sup>C bus register for adjustment of the cut-off voltage.

The auto cut-off loop is configured as described below.

- The B, G and R reference pulses for auto cut-off, shifted 1H each in the order mentioned, are added to the top of picture.
- The 1k of each of the R, G and B outputs is converted into a voltage before it is input to Pin 25.
- The voltage input to Pin 25 is compared with the reference voltage in the IC to change the DC level of reference pulse.

(The DC level is changed by changing the DC shift amount of each of the R, G and B outputs.)

The loop mentioned above determines the DC shift amount of each of the R, G and B outputs and lets the capacities connected to Pins 19, 21 and 23 hold the DC shift amounts during the 1V section. If the voltage at any of the Pins 19, 21 and 23 is less than 4.2V, the R, G and B outputs except the reference pulses are blanked. The positions of reference pulses can be changed by the I<sup>2</sup>C bus register.

Positions of reference pulses

REF	Pin 40: 0V			Pin 40: 4.5V			Pin 40: 9V		
	R	G	B	R	G	B	R	G	B
00	20H	19H	18H	27H	26H	25H	34H	33H	32H
01	22H	21H	20H	30H	29H	28H	38H	37H	36H
10	24H	23H	22H	33H	32H	31H	42H	41H	40H
11	26H	25H	24H	36H	35H	34H	46H	45H	44H

R, G and B output V blanking and VBLK go low at 3H and go high (V blanking canceled) at R reference pulse position +3H.

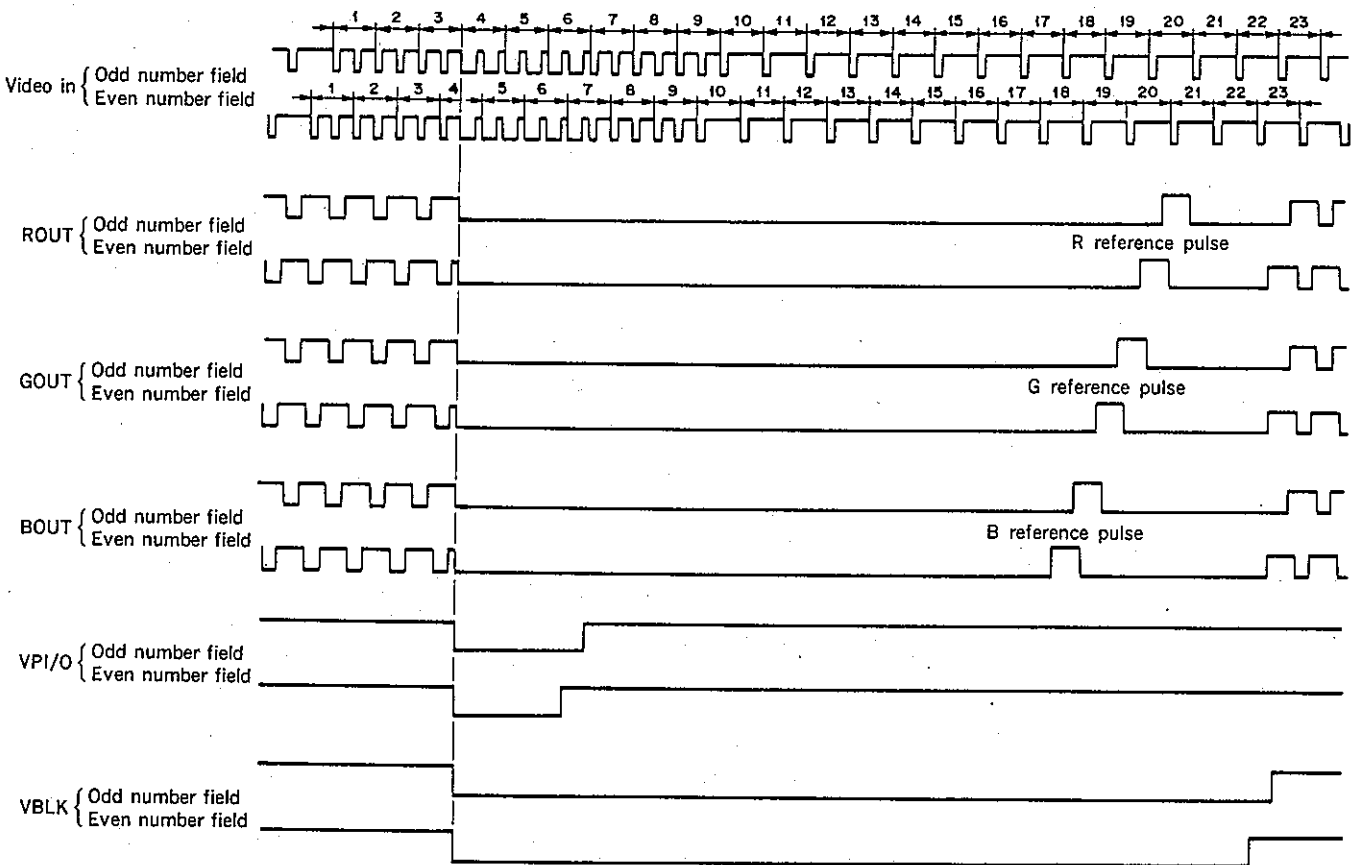

Automatic cut-off reference pulse time chart (Ref; Pins 0 and 40: 0V)

[Picture muting mode]

- Mode where all, including reference pulses, are picture muted
  - When XRAY is input
  - PMUTE: 0
  - OFFNV: 0
- Mode where all except reference pulses are picture muted
  - OFFNR: 0 (ROUT only)
  - OFFNG: 0 (GOUT only)
  - OFFNB: 0 (BOUT only)
  - When I<sub>k</sub> pin voltage is so low that S/H pin voltage at any of Pins 19, 21 and 23 is lower than 4.2V

**Definition of I<sup>2</sup>C Bus Register**

**Slave addresses**

- 88<sub>H</sub>: SLAVE RECEIVER
- 89<sub>H</sub>: SLAVE TRANSMITTER

**Register table**

- All registers are set at 0 when the IC is reset.
- '\*' is not defined.

[Control registers]

Sub Address	bit 7	bit 6	bit 5	bit 4	bit 3	bit 2	bit 1	bit 0
XXX00000	HFREQ							PMUTE
XXX00001	VFREQ				*	VSMO	VTRIG	
XXX00010	VSHIFT				*	*	OFFNV	
XXX00011	VSIZE					*	*	
XXX00100	VLIN			*	VCOMP			
XXX00101	HPHASE			*	*	AFC		
XXX00110	HSIZE				*	REF		
XXX00111	PINAMP				CORNER PIN			
XXX01000	PIN PHASE			VS CORR				
XXX01001	GAMP				*	0	ALIGN	
XXX01010	BAMP				*	*	*	
XXX01011	GCUTOFF			*	OFFNR	OFFNG	OFFNB	
XXX01100	BCUTOFF			*	DYCOL	RGB		
XXX01101	CHRTRAP					*	OFFCT	
XXX01110	PICTURE						*	
XXX01111	HUE						*	
XXX10000	SATURATION						OFFTOT	
XXX10001	BRIGHTNESS						BLM	
XXX10010	SHARPNESS			*	*	*	*	
XXX10011	RGBPIX						DRGBP	
XXX11100	CTL							

[Status register]

1st byte	bit 7	bit 6	bit 5	bit 4	bit 3	bit 2	bit 1	bit 0
	PONRES	HLOCKN	HCENT	0	0	IK	0	0
2st byte	RET							

**Description of Registers**

H FREQ (7): H f<sub>o</sub> adjustment

- 0=Maximum frequency
- 127=Minimum frequency

P MUTE (1): Picture muting ON/OFF

0=Picture muting ON (Auto cut-off reference pulse is also muted.)

1=Picture muting OFF

V FREQ (5): V f<sub>o</sub> adjustment

0=Maximum frequency

31=Minimum frequency

VSMO (1): To switch between V lock ranges

0=Normal range (Pull-in range=55 to 65Hz)

1=Wide range (Pull-in range=45 to 75Hz)

VTRIG (1): To switch internal and external V triggers and input and output definitions

0=To derive V trigger from inside (Pin 29 to serve as output)

1=To input V trigger from outside (Pin 29) (Pin 29 to serve as input)

V SHIFT (5): V shift

0=To raise

31=To lower

OFFNV (1): V-OUT ON/OFF

0=Stops outputting V-OUT (At the same time, picture muting begins. In the picture muting mode, the reference pulse for auto cut-off is also muted.)

1=Outputs V-OUT

V SIZE (6): V size

0=Minimum

63=Maximum

V LINEARITY (4): V linearity

0=To compress upper part of picture and expand lower part of picture

15=To expand upper part of picture and compress lower part of picture

V COMP (3): V zooming correction

0=Minimum

7=Maximum

H PHASE (4): H center

0=To move picture to maximum left-sided position

15=To move picture to maximum right-sided position

AFC (2): To switch AFC

AFC1	AFC0	
0	0	AFC loop gain intermediate
0	1	AFC loop gain small
1	0	AFC loop gain large
1	1	AFC loop open

H-SIZE (5): H size

0=Minimum

31=Maximum

REF (2): To switch auto cut-off reference pulse position

REF1	REF0	
0	0	B=18H, G=19H, R=20H
0	1	B=20H, G=21H, R=22H
1	0	B=22H, G=23H, R=24H
1	1	B=24H, G=25H, R=26H

PIN AMP (5): Pin amp.

0=Minimum

31=Maximum

CORNER PIN (3): Corner pin

0=Minimum

31=Maximum

PIN PHASE (4): Pin phase

0=To widen upper part of picture and narrow lower part of picture

15=To narrow upper part of picture and widen lower part of picture

VS CORR (4): S-correction of V

0=Minimum

31=Maximum

G AMP (5): To adjust green drive (red drive fixed)

0=Minimum gain

31=Maximum gain

ALIGN (1): To switch between HCENT status register valid and invalid

0=HCENT invalid (Normal mode)

1=HCENT valid (H-FREQ adjustment mode)

B AMP (5): To adjust blue drive (red drive fixed)

0=Minimum gain

31=Maximum gain

G CUT OFF (4): To adjust green cut-off voltage (red cut-off voltage fixed)

0=Minimum

15=Maximum

OFFNR (1): Red output ON/OFF

0=Red output OFF

1=Red output ON

OFFNG (1): Green output ON/OFF

0=Green output OFF

1=Green output ON

OFFNB (1): Blue output ON/OFF

- 0=Blue output OFF
- 1=Blue output ON

B CUTOFF (4): To adjust blue cutoff voltage (read cut off voltage fixed)

- 0=Minimum
- 15=Maximum

DYCOL (1): New dynamic color (12500K) ON/OFF

- 0=New dynamic color OFF
- 1=New dynamic color ON

RGB (2): To switch RGB source

RGB1	RGB0	
0	0	To select TV or external R, G and B inputs (Pins 16 through 18). There are switched by Y <sub>s</sub> (Pin 15).
1	0	To select external R, G and B inputs
-	1	To select TV

CHRTRAP (6): To adjust Y/C system filters such as 3.58MHz chroma trap

- 0=Minimum trap frequency
- 63=Maximum trap frequency

OFFCT (1): Chroma trap ON/OFF

- 0=Chroma trap ON
- 1=Chroma trap OFF

PICTURE (7): Picture

- 0=Minimum
- 127=Maximum

HUE (7): Hue

- 0=Flesh color nearer to green
- 127=Flesh color nearer to red

SATURATION (7): Color

- 0=Minimum
- 127=Maximum

OFFTOT (1): TOT filter ON/OFF

- 0=To pass through TOT filter
- 1=To bypass TOT filter

BRIGHTNESS (7): Brightness

- 0=Minimum
- 127=Maximum



BLM (1): To switch ABL mode

- 0=Combined picture ABL and brightness ABL mode
- 1=Picture ABL (including brightness ABL for protection)

SHARPNESS (4): Sharpness

- 0=Minimum sharpness gain
- 15=Maximum sharpness gain

RGB PICTURE (7): Picture of external R, G and B inputs (Pins 16 through 18)

- 0=Minimum
- 127=Maximum

DRGBP (1): To switch brightness of external digital R, G and B inputs for screen display

- 0=0dB
- 1=-3dB

CTL (8): Used for testing I<sup>2</sup>C bus decoder

PONRES (1): To detect POWER ON RESET

- 0=Set at 0 after master has read this status via bus
- 1=Set at 1 when power is turned on or when power dip occurs

HLOCKN (1): To return H f<sub>o</sub> status to indicate whether it is locked or not locked to H frequency of signal during H f<sub>o</sub> adjustment

- 0=Not locked to H of signal
- 1=Locked to H of signal

HCENT (1): To return H f<sub>o</sub> relation to indicate whether it is smaller or large than H frequency of signal during H f<sub>o</sub> adjustment

- 0=F<sub>osc</sub> < F<sub>H</sub> (signal input)
- 1=F<sub>osc</sub> > F<sub>H</sub> (signal input)

IK (1): To return Ik current status to indicate whether it is stable or not

- 0=All Ik currents of R, G and B in stable state
- 1=Ik currents unstable

RET (8): Used for testing I<sup>2</sup>C bus decoder. Data written into the CTL register is directly returned.

Picture control characteristics

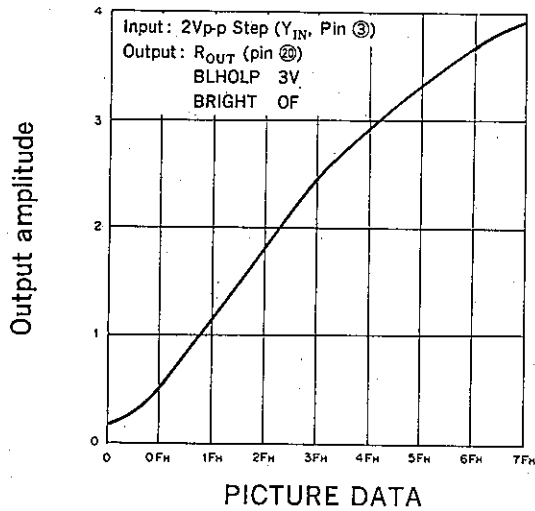

I/O characteristics

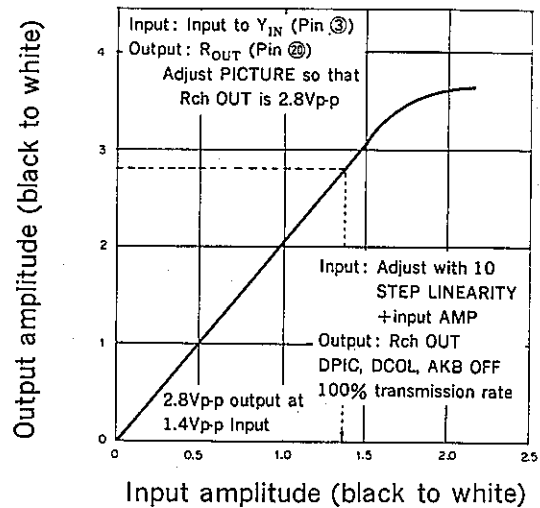

I/O characteristics of auto pedestal close loop

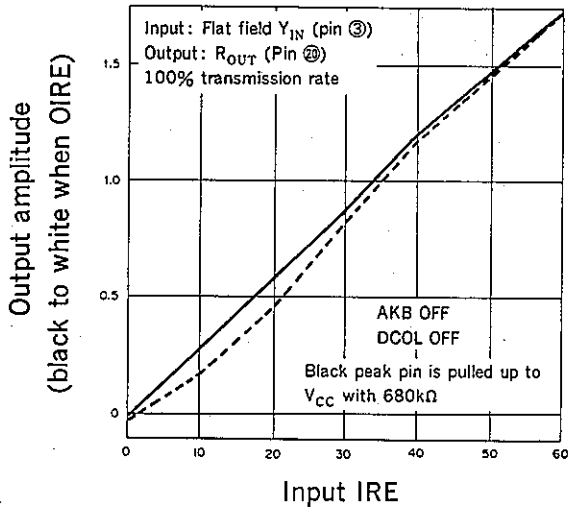

DC transmission ratio

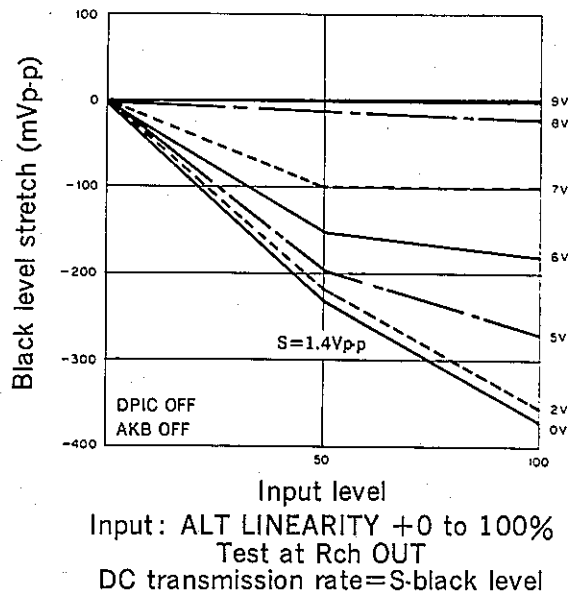

ABL static characteristics (amplitude)

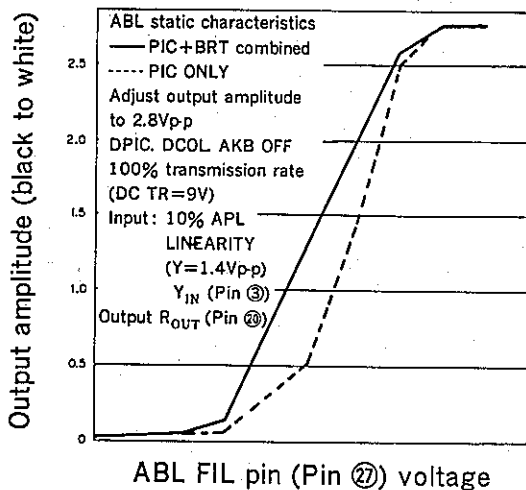

ABL static characteristics (black level)

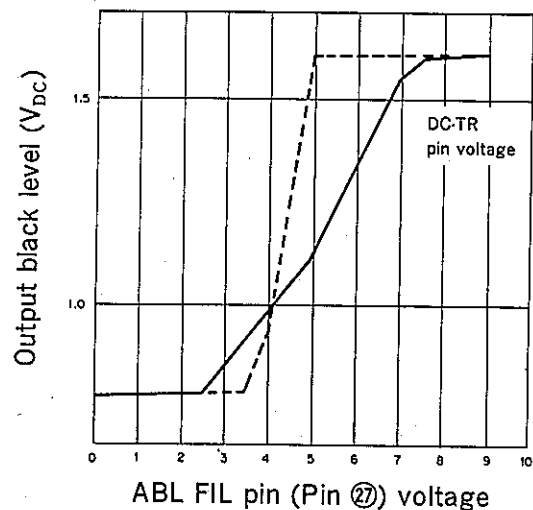

Pull-in at PIC+BRT ABL combined mode

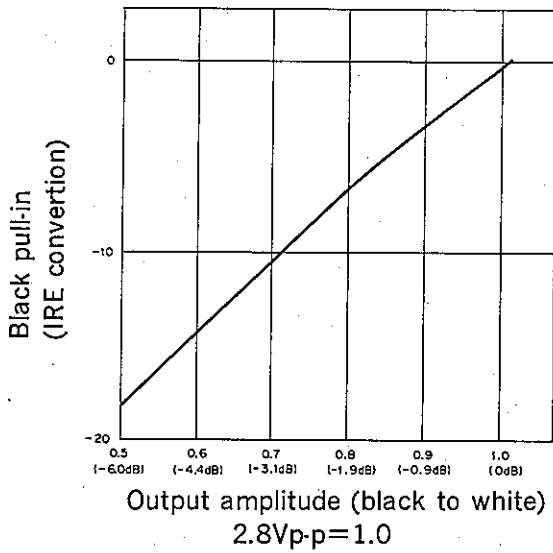

Drive control characteristics

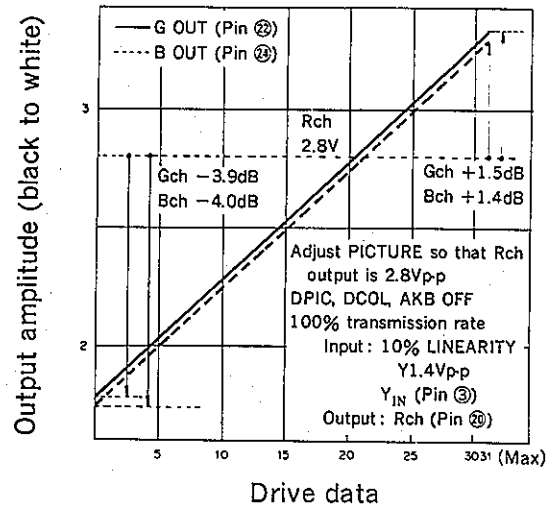

Cut-off control characteristics

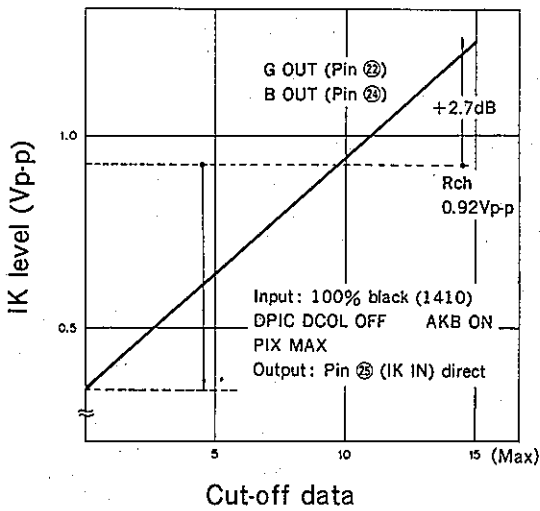

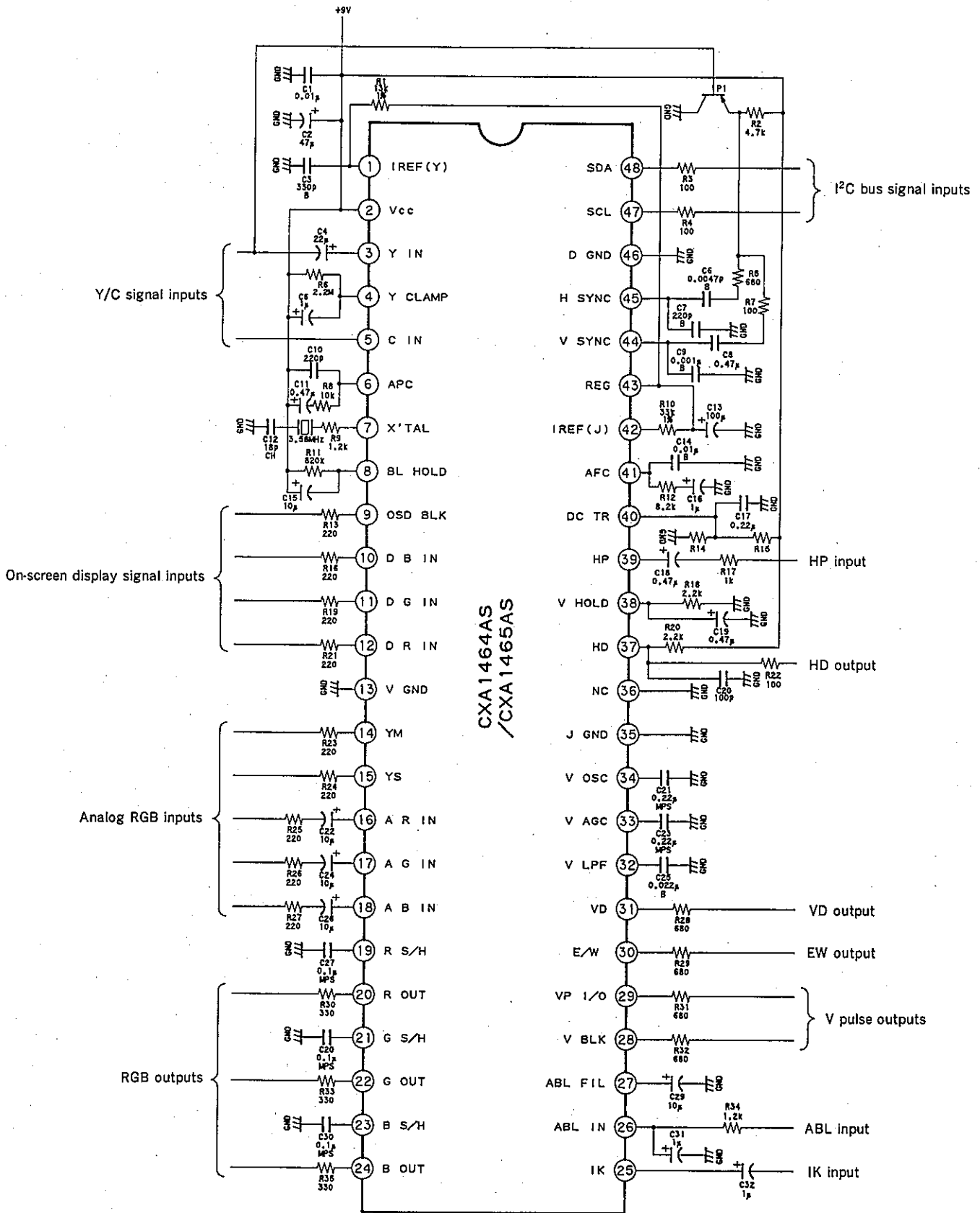

Package Outline Unit: mm

48pin SDIP (Plastic) 600mil 5.1g

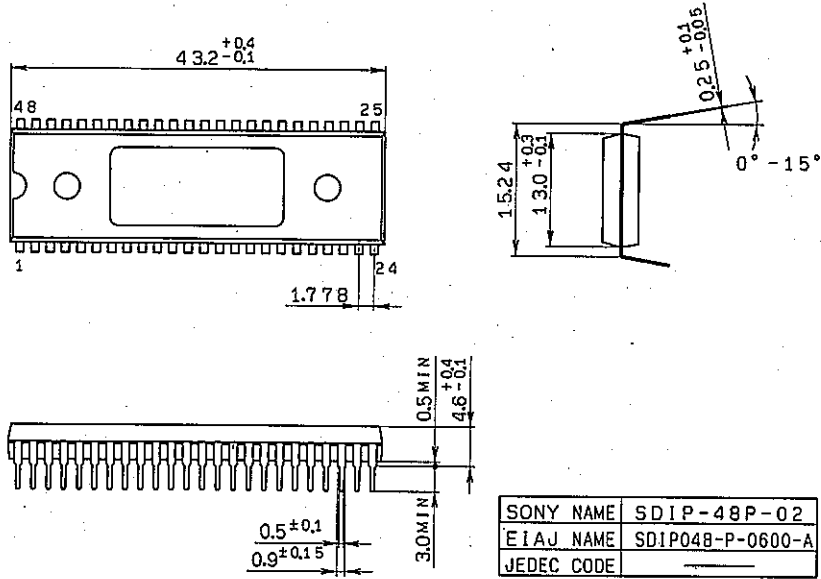

NOTE : PALLADIUM PLATING  
 This product uses S-PdPPF (Sony Spec.-Palladium Pre-Plated Lead Frame).