



SANYO Semiconductors

DATA SHEET

An ON Semiconductor Company

LV0104CS

Monolithic Linear IC

Halogen-free

Digital Ambient Light Sensor

Overview

LV0104CS is a Photo IC for micro-sized Ambient Light sensor which has the characteristics of spectral response similar to that of human eyes. It is suitable for the applications like mobile phone (for Digital-TV, One-segment), LCD-TV, laptop computer, PDA, DSC and Camcorder.

Functions

- Smallest OD-CSP package in the world (1.08mm × 1.08mm thickness: 0.6mm)
- Great spectrum sensitivity characteristic
- 16-Bit Digital Output for I²C-BUS
- Low Current consumption, Integrated Sleep function

Specifications

Absolute Maximum Ratings at Ta=25°C

Parameter	Symbol	Conditions	Ratings	Unit
Power Supply Voltage	V _{DD}		4.0	V
Logic I/O levels	V _{IO}		-0.3 to V _{DD} +0.3	V
Operating temperature range	T _{opr}		-30 to 85	°C
Storage temperature range	T _{stg}		-40 to 100	°C

Recommended Operating Conditions at Ta = 25°C

Parameter	Symbol	Condition	Min.	Typ	Max.	Unit
Recommended Supply Voltage	V _{DD op}		2.3	2.5	3.6	V
Input low level voltage	V _{IL}	SCL, SDA			0.55	V
Input high level voltage	V _{IH}	SCL, SDA, V _{DD} =2.8V	1.26			V
Output low level voltage	V _{OL}	SDA, IOL=3mA			0.4	V
Input leak current	I _{LEAK}	SCL, SDA	-5		5	μA

* I²C interface(SCL,SDA) is for V_{io}=1.8V operation.

- Any and all SANYO Semiconductor Co.,Ltd. products described or contained herein are, with regard to "standard application", intended for the use as general electronics equipment. The products mentioned herein shall not be intended for use for any "special application" (medical equipment whose purpose is to sustain life, aerospace instrument, nuclear control device, burning appliances, transportation machine, traffic signal system, safety equipment etc.) that shall require extremely high level of reliability and can directly threaten human lives in case of failure or malfunction of the product or may cause harm to human bodies, nor shall they grant any guarantee thereof. If you should intend to use our products for new introduction or other application different from current conditions on the usage of automotive device, communication device, office equipment, industrial equipment etc. , please consult with us about usage condition (temperature, operation time etc.) prior to the intended use. If there is no consultation or inquiry before the intended use, our customer shall be solely responsible for the use.
- Specifications of any and all SANYO Semiconductor Co.,Ltd. products described or contained herein stipulate the performance, characteristics, and functions of the described products in the independent state, and are not guarantees of the performance, characteristics, and functions of the described products as mounted in the customer's products or equipment. To verify symptoms and states that cannot be evaluated in an independent device, the customer should always evaluate and test devices mounted in the customer's products or equipment.

SANYO Semiconductor Co., Ltd.

<http://www.sanyosemi.com/en/network/>

LV0104CS

Electrical Characteristics at Ta = 25°C, VCC = 5V

Parameter	Symbol	Conditions	Min.	Typ	Max.	Unit
Supply Current	I _{DD}	Ev=0 lux		70	100	μA
Sleep Current	I _{SLP}	Sleep mode, Ev=0 lux			1	μA
Internal Oscillator Frequency	f _{OSC}			655		kHz
Dark ADC count value	D0	Ev=0 lux, High gain mode			5	counts
Full scale ADC count value	D max				65535	counts
ADC count value	Data HH	Gain×8mode, Ev=1000lx		8000		counts
	Data HM	Gain×2 mode, Ev=1000lx		2000		counts
	Data N	Gain×1 mode, Ev=1000lx	750	1000	1250	counts
	Data L	Gain×0.25 mode, Ev=1000lx		250		counts
Resolution	ReHH1	Tint=200ms, Gain×8 mode		0.125		lx
	ReHH2	Tint=100ms, Gain×8 mode		0.25		lx
	ReHH3	Tint=12.5ms, Gain×8 mode		2		lx
	ReHM1	Tint=200ms, Gain×2 mode		0.5		lx
	ReHM2	Tint=100ms, Gain×2 mode		1		lx
	ReHM3	Tint=12.5ms, Gain×2 mode		8		lx
	ReN1	Tint=200ms, Gain×1 mode		1		lx
	ReN2	Tint=100ms, Gain×1 mode		2		lx
	ReN3	Tint=12.5ms, Gain×1 mode		16		lx
	ReL1	Tint=200ms, Gain×0.25 mode		4		lx
	ReL2	Tint=100ms, Gain×0.25 mode		8		lx
	ReL3	Tint=12.5ms, Gain×0.25 mode		64		lx

Package Dimensions

unit : mm (typ)

3371

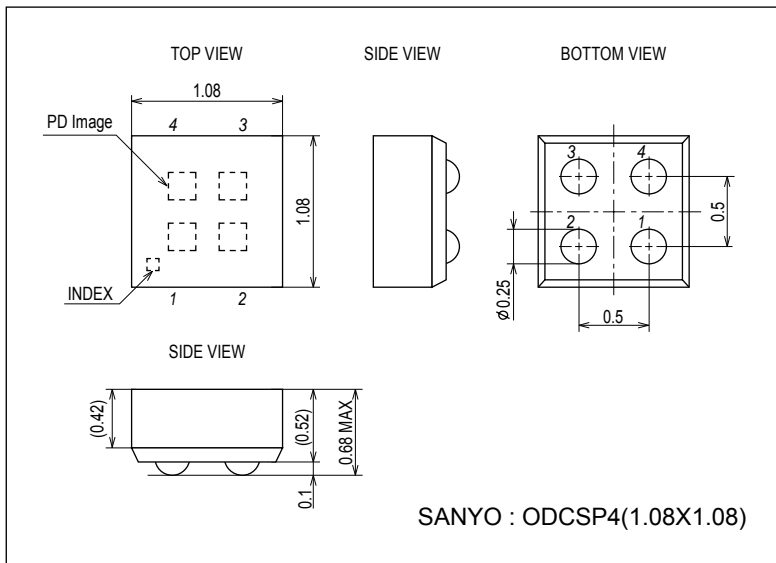

Pad layout

<Top view>

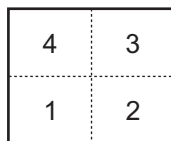

<Bottom view>

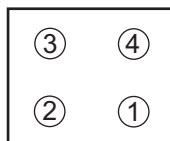

Ball Pitch: 0.5mm, Ball Size: 0.25mm

No.	Name	Function
1	VCC	Supply voltage pin
2	GND	GND pin
3	SCL	I ² C serial clock
4	SDA	I ² C serial data

Spectrum Sensitivity Characteristic

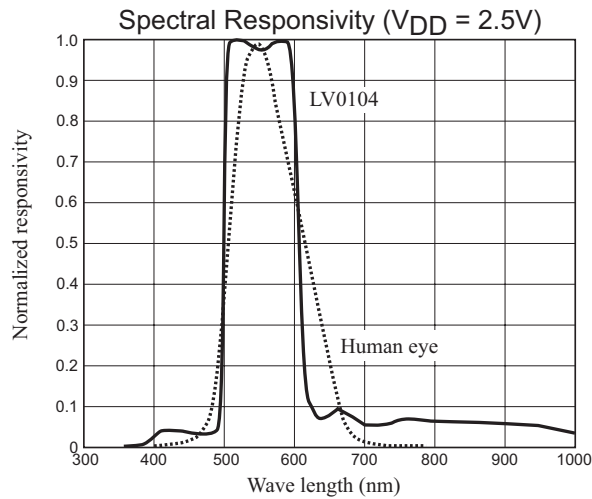

I²C Interface

The control command is received from the operation of the device by the I²C bus (Two-wire serial interface). The obtained data is output to the operation by the I²C bus.

I²C Bus Timing Diagram

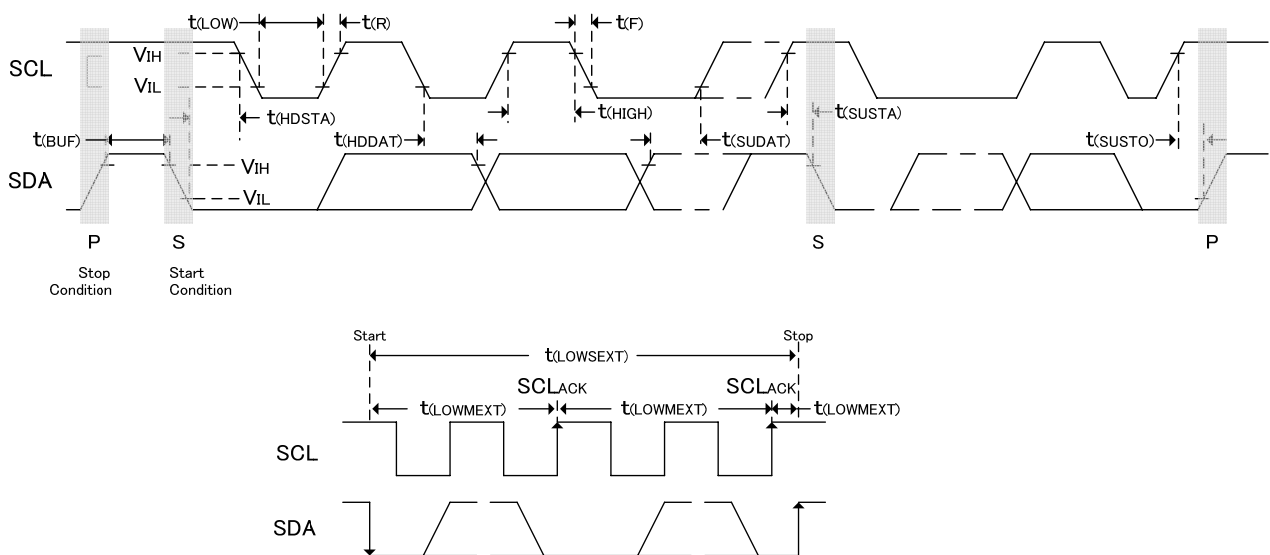

Serial Interface Timing

Parameter	Symbol	Standard Mode		Fast Mode		Unit
		Min	Min	Min	Max	
Clock frequency	f(SCL)	10	100	10	400	kHz
Bus free time between start and stop condition	t(BUF)	4.7		1.3		µs
Hold time after (repeated) start condition. After this period, the first	t(HDSTA)	4.0		0.6		µs
Repeated start condition setup time	t(SUSTA)	4.7		0.6		µs
Stop condition setup time	t(SUSTO)	4.0		0.6		µs
Data hold time	t(HDDAT)	300		90		ns
Data setup time	t(SUDAT)	250		100		ns
I ² C clock (SCL) low period	t(LOW)	4.7		1.3		µs
I ² C clock (SCL) high period	t(HIGH)	4.0		0.6		µs
Clock / data fall time	t(F)		300		300	ns
Clock / data rise time	t(R)		1000		300	ns

*Specified by design and characterization ; not production tested.

LV0104CS

Data Format (Write)

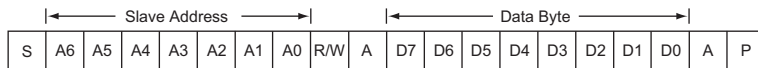

Data Format (Read)

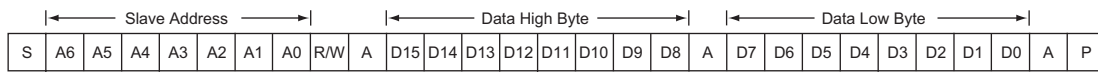

•Slave Address

A6	A5	A4	A3	A2	A1	A0	R/W
0	0	1	0	0	1	1	X

R/W: Read: 1, Write: 0

(1) Write Protocol (R/W=0)

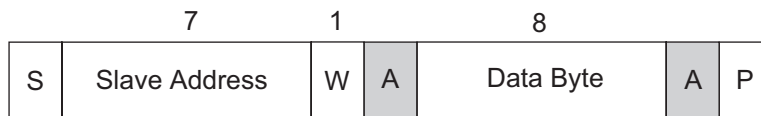

(2) Read Protocol (R/W=1)

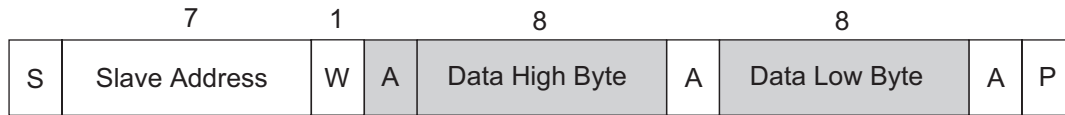

Master to Slave Slave to Master

S: Start Condition
P: Stop Condition
A: Acknowledge
W: Write
R: Read

Register Set

(1) Measurement

	D7	D6	D5	D4	D3	D2	D1	D0
Name	MODE1	MODE0	-	GAIN1	GAIN0	INTEG1	INTEG0	MANUAL
	11:Active			00: x0.25 01: x1 10: x2 11: x8		00: 12.5ms 01: 100ms 10: 200ms 11: Manual		0: Start 1: Stop
Default	00		1	0	1	10		0

(2) Sleep mode

	D7	D6	D5	D4	D3	D2	D1	D0
Name	MODE1	MODE0	-	-	-	-	-	-
	00:Sleep		x	x	x	x	x	x
Default	00		x	x	x	x	x	x

(3) Setting Sensitivity

	D7	D6	D5	D4	D3	D2	D1	D0
Name	MODE1	MODE0	ADJ5	ADJ4	ADJ3	ADJ2	ADJ1	ADJ0
	10:Setting		0: Minus 1: Plus	ADJ4	ADJ3	ADJ2	ADJ1	ADJ0
Default	00		0	0	0	0	0	0

LV0104CS

Bits D5 to D0						Description
ADJD	ADJ4	ADJ3	ADJ2	ADJ1	ADJ0	
0	0	0	0	0	1	66.7%
.	
0	0	1	0	1	0	95.2%
.	
1	0	0	1	1	0	108.3%
.	
1	0	0	0	0	1	150%

<Width of sensitivity adjustment>

66.7% to 150% (ADJ5 to ADJ0=000001=66.7%, ADJ5 to ADJ0 = 100001 = 150%)

<Sensitivity Calculation>

- Decreasing Sensitivity (ADJ5=0)

$$S_n = 16 \cdot \text{ADJ4} + 8 \cdot \text{ADJ3} + 4 \cdot \text{ADJ2} + 2 \cdot \text{ADJ1} + \text{ADJ0}$$

$$S = 2 \cdot S_n / (2 \cdot S_n + 1)$$

(Example) ADJ5 to ADJ0 = 001010, $S_n = 8 + 2 = 10$, $S = 20 / 21 = 0.952$. The sensitivity is 95.2%

- Increasing Sensitivity (ADJ5=1)

$$S_n = 16 \cdot \text{ADJ4} + 8 \cdot \text{ADJ3} + 4 \cdot \text{ADJ2} + 2 \cdot \text{ADJ1} + \text{ADJ0}$$

$$S = (2 \cdot S_n + 1) / 2 \cdot S_n$$

(Example) ADJ5 to ADJ0 = 100110, $S_n = 4 + 2 = 6$, $S = 13 / 12 = 1.083$. The sensitivity is 108.3%.

(4) Read data

Measurement result is registered to ADC channel data registers (DH,DL) in below format.

	D15	D14	D13	D12	D11	D10	D9	D8
DH (Data Higher byte)	DH7(2 ¹⁵)	DH6(2 ¹⁴)	DH5(2 ¹³)	DH4(2 ¹²)	DH3(2 ¹¹)	DH2(2 ¹⁰)	DH1(2 ⁹)	DH0(2 ⁸)

	D7	D6	D5	D4	D3	D2	D1	D0
DL (Data Lower byte)	DL7(2 ⁷)	DL6(2 ⁶)	DL5(2 ⁵)	DL4(2 ⁴)	DL3(2 ³)	DL2(2 ²)	DL1(2 ¹)	DL0(2 ⁰)

- Lux calculation

(Example)

DH = "0010_0100" (DH5, DH2 = 1)

DL = "1000_0001" (DL7, DL0 = 1)

$$2^{13}(8192) + 2^{10}(1024) + 2^7(128) + 2^0(1) = 9345[\text{lx}]$$

LV0104CS

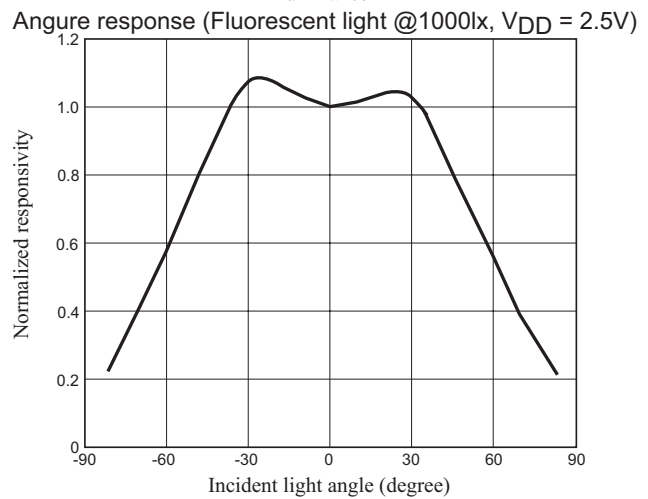
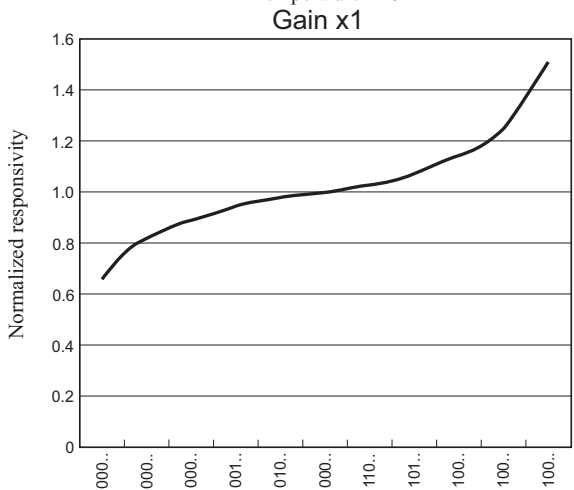
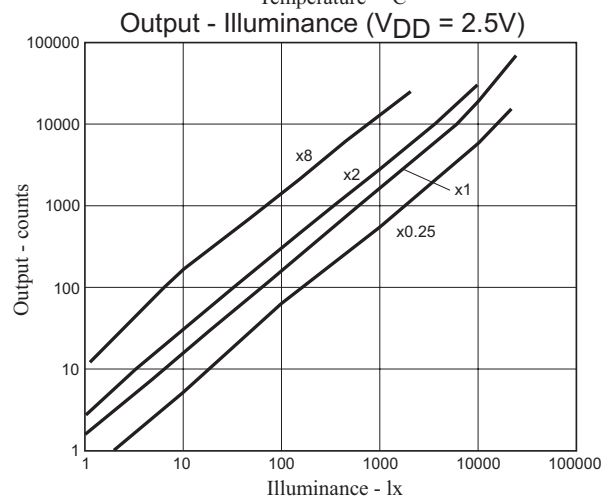
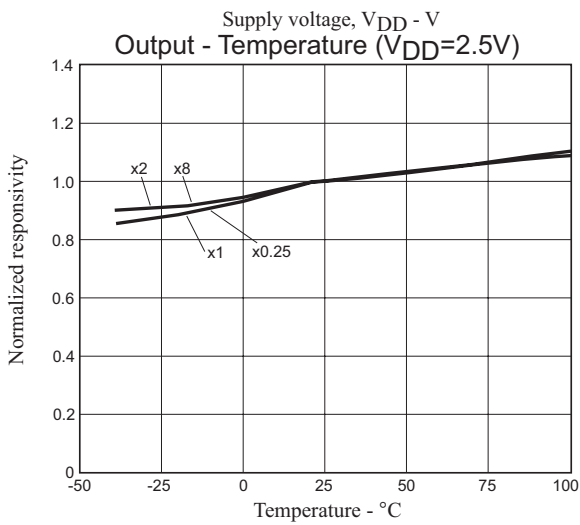
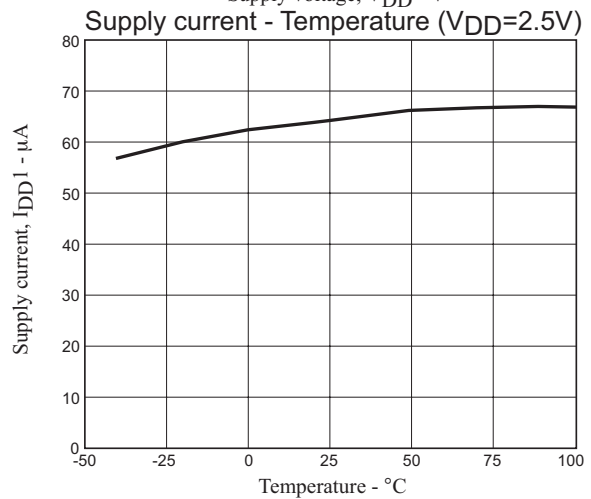
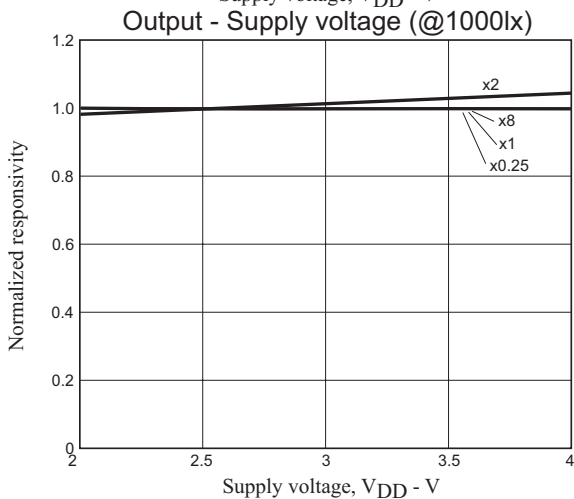
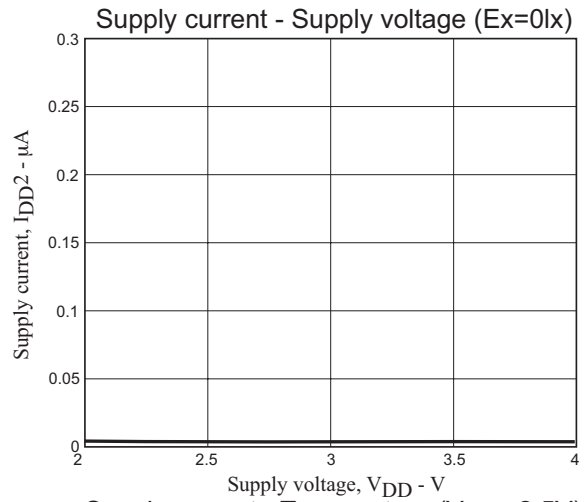
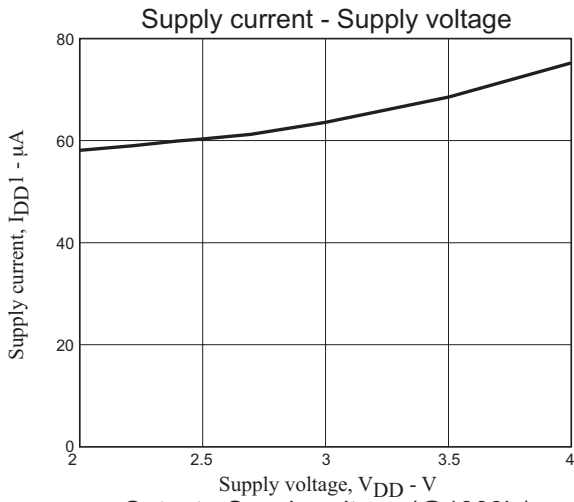

- SANYO Semiconductor Co.,Ltd. assumes no responsibility for equipment failures that result from using products at values that exceed, even momentarily, rated values (such as maximum ratings, operating condition ranges, or other parameters) listed in products specifications of any and all SANYO Semiconductor Co.,Ltd. products described or contained herein.
- Regarding monolithic semiconductors, if you should intend to use this IC continuously under high temperature, high current, high voltage, or drastic temperature change, even if it is used within the range of absolute maximum ratings or operating conditions, there is a possibility of decrease reliability. Please contact us for a confirmation.
- SANYO Semiconductor Co.,Ltd. strives to supply high-quality high-reliability products, however, any and all semiconductor products fail or malfunction with some probability. It is possible that these probabilistic failures or malfunction could give rise to accidents or events that could endanger human lives, trouble that could give rise to smoke or fire, or accidents that could cause damage to other property. When designing equipment, adopt safety measures so that these kinds of accidents or events cannot occur. Such measures include but are not limited to protective circuits and error prevention circuits for safe design, redundant design, and structural design.
- In the event that any or all SANYO Semiconductor Co.,Ltd. products described or contained herein are controlled under any of applicable local export control laws and regulations, such products may require the export license from the authorities concerned in accordance with the above law.
- No part of this publication may be reproduced or transmitted in any form or by any means, electronic or mechanical, including photocopying and recording, or any information storage or retrieval system, or otherwise, without the prior written consent of SANYO Semiconductor Co.,Ltd.
- Any and all information described or contained herein are subject to change without notice due to product/technology improvement, etc. When designing equipment, refer to the "Delivery Specification" for the SANYO Semiconductor Co.,Ltd. product that you intend to use.
- Upon using the technical information or products described herein, neither warranty nor license shall be granted with regard to intellectual property rights or any other rights of SANYO Semiconductor Co.,Ltd. or any third party. SANYO Semiconductor Co.,Ltd. shall not be liable for any claim or suits with regard to a third party's intellectual property rights which has resulted from the use of the technical information and products mentioned above.

This catalog provides information as of Jun, 2012. Specifications and information herein are subject to change without notice.