

Power Resistors



MTR Series

MERITEK

Features

- TO-220 / TO-247 style power package
- Molded case for protection and easy mounting
- Electrically isolated case
- Non-Inductive design

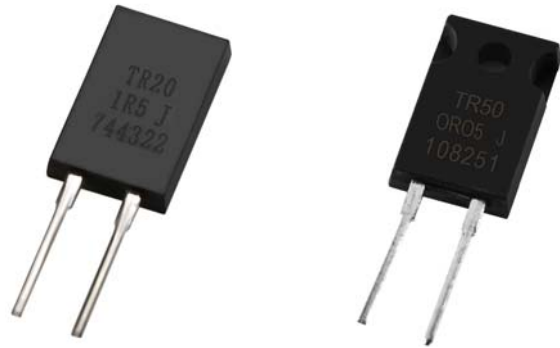

Part Numbering System

MTR	20	J	B	D	1001	-H
Product Type	Power	Resistance Tolerance	Packaging Code	TCR (PPM/°C)	Resistance	Code
	20: 20 Watts 30: 30 Watts 35: 35 Watts 50: 50 Watts 100: 100 Watts	D: ±0.5% F: ±1% J: ±5% K: ±10%	B: Bulk	D: ±50 E: ±100 F: ±200 G: ±300 -: No Specified	R100: 0.1Ω 0100: 10Ω 4700: 470Ω 1001: 1000Ω 1002: 10000Ω	H: Mounting Hole

Construction

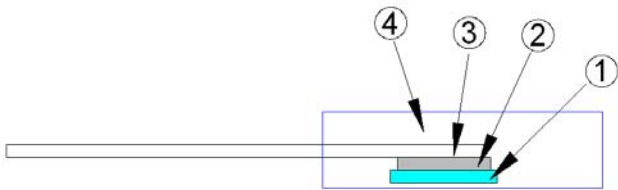

① Alumina Substrate	③ Lead
② Resistor Layer	④ Molded Package

Power Package

Type	Power Package
MTR20	TO-220
MTR30	TO-220
MTR35	TO-220
MTR50	TO-220
MTR50-H	TO-220
MTR100	TO-247

Power Resistors



MTR Series

MERITEK

Environmental Characteristics

Item	Requirement	Test Method
Temperature Coefficient of Resistance (T.C.R.)	As Specified.	Referenced to 25°C, ΔR taken at +105°C
Short Time Overload	$\Delta R \pm 0.3\%$	2 times rated power with applied voltage not to exceed 1.5 times maximum continuous operating voltage for 5 seconds
Load Life	$\Delta R \pm 1.0\%$	2,000 hours at rated power
Damp Heat with Load	$\Delta R \pm 0.5\%$	40±2°C, 90~95% R.H. Max. working voltage for 1000 hrs with 1.5 hrs "ON" and 0.5 hrs "OFF"
Solderability	90% min. coverage	245±5°C for 3 seconds
Thermal Shock	$\Delta R \pm 0.3\%$	-65°C ~150°C, 100 cycles
Terminal Strength	$\Delta R \pm 0.2\%$	(Pull Test) 2.4N
Vibration, High Frequency	$\Delta R \pm 0.2\%$	20g peak

- Lead Material: Tinned Copper
- Maximum Torque: 0.9 N-m
- Without a Heat Sink, When in Free Air at 25°C, it is rated for 2.25W.
- The Case Temperature is to be used for the Definition of the Applied Power Limit.
- The Case Temperature Measurement Must be Made with a Thermocouple Contacting the Center of the Component Mounted on the Designed Heat Sink.
- Thermal Grease Should be Applied Properly.

Power Resistors



MTR Series	MERITEK
------------	----------------

MTR20

Dimensions

Type	Weight (g) (1000pcs)
MTR20	1290

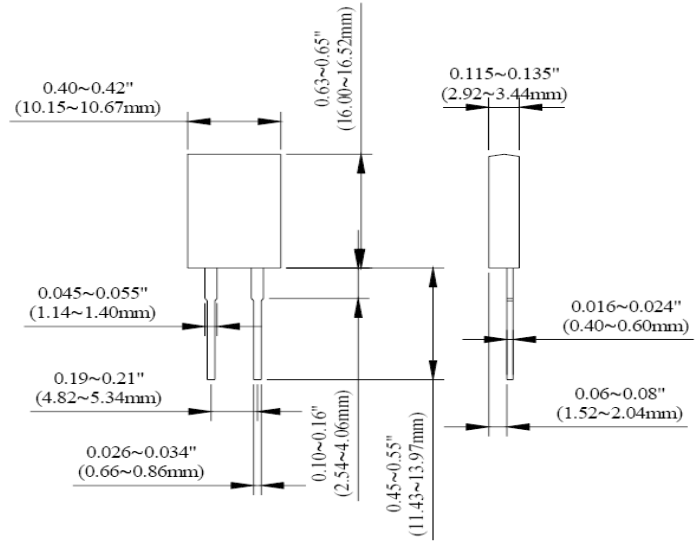

Derating Curve

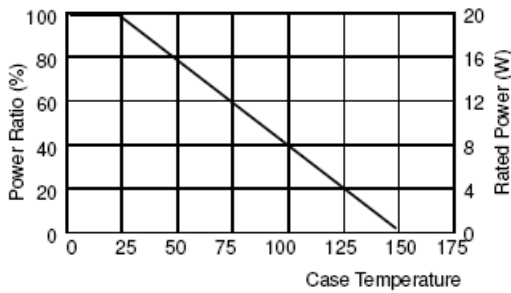

Electrical Characteristics Specifications

Item	Resistance Range				TCR (PPM/°C)
	±0.5%	±1%	±5%	±10%	
MTR20	-	-	0.05Ω -1Ω		
	-	>1Ω -3Ω			±300
	-	>3Ω -10Ω			±100 ±200
	>10Ω -10KΩ				±50 ±100 ±200

- Operating Voltage: 350Vmax
- Dielectric Strength: 1800V_{AC}
- Insulation Resistance: 10GΩ min.
- Working Temperature Range: -65°C to +150°C
- Resistance Value < 1Ω is available

Power Resistors



MTR Series

MERITEK

MTR30

Dimensions

Type	Weight (g) (1000pcs)
MTR30	1155

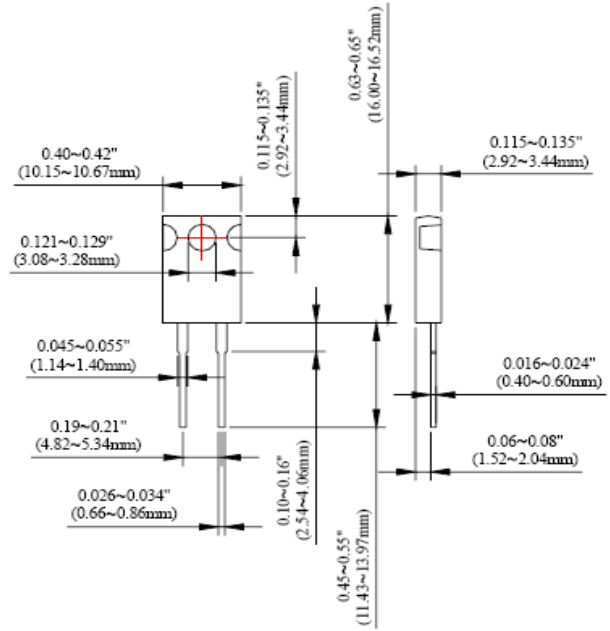

Derating Curve

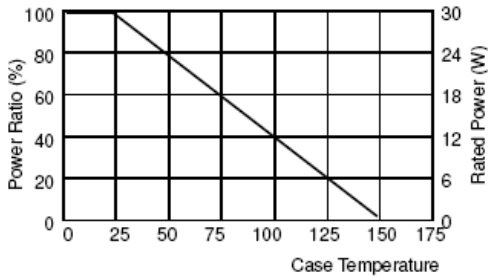

Electrical Characteristics Specifications

Item	Resistance Range				TCR (PPM/°C)
	±0.5%	±1%	±5%	±10%	
MTR30	-	-	0.05Ω -1Ω		±300
	-	-	>1Ω -3Ω		±100
	-	-	>3Ω -10Ω		±200
	-	-	>10Ω -10KΩ		±50 ±100 ±200

- Operating Voltage: 420Vmax
- Dielectric Strength: 1800V_{AC}
- Insulation Resistance: 10GΩ min.
- Working Temperature Range: -65°C to +150°C
- Resistance Value < 1Ω is available

Power Resistors



MTR Series

MERITEK

MTR35

Dimensions

Type	Weight (g) (1000pcs)
MTR35	1902

Derating Curve

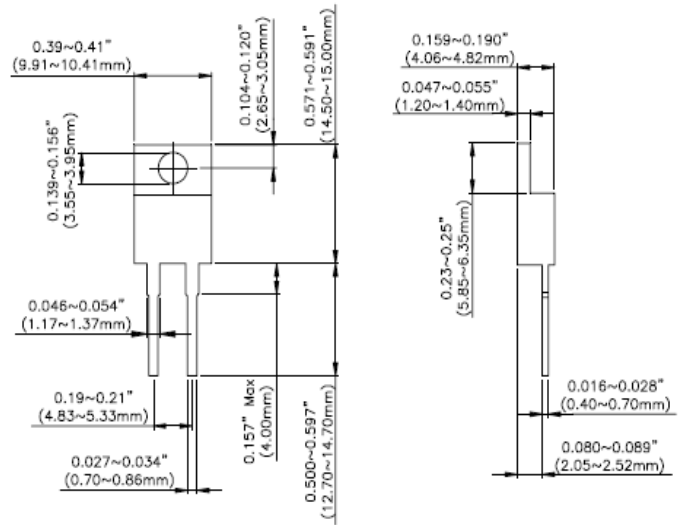
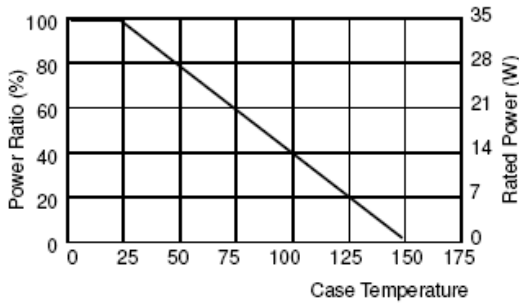

Electrical Characteristics Specifications

Item	Resistance Range	TCR (PPM/°C)			
		±0.5%	±1%	±5%	±10%
MTR	0.05Ω - 0.1Ω	/	/	-	-
	>0.1Ω - 1Ω	/	/	-	-
	>1Ω - 3Ω	/	±300	±300	±300
	>3Ω - 10Ω	/	±100 ±200	±100 ±200	±100 ±200
	>10Ω - 10KΩ	±50 ±100 ±200	±50 ±100 ±200	±50 ±100 ±200	±50 ±100 ±200

- Operating Voltage: 350V_{Max}
- Dielectric Strength: 1800V_{AC}
- Insulation Resistance: 10GΩ min.
- Working Temperature Range: -65°C to +150°C
- Resistance Value < 1Ω is available

Power Resistors



MTR Series

MERITEK

MTR50

Dimensions

Type	Weight (g) (1000pcs)
MTR50	1290

Derating Curve

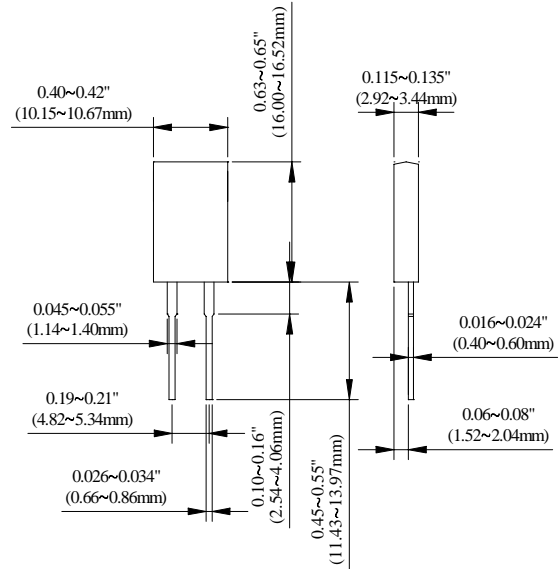
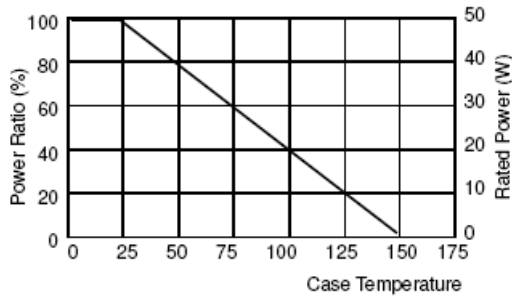

Electrical Characteristics Specifications

Item	Resistance Range				TCR (PPM/°C)
	±0.5%	±1%	±5%	±10%	
Type	-	-	0.1Ω -1Ω		
	-	>1Ω -3Ω			±300
	-	>3Ω -10Ω			±100 ±200
	>10Ω -10KΩ				±50 ±100 ±200

- Operating Voltage: 350V_{Max}
- Dielectric Strength: 1800V_{AC}
- Insulation Resistance: 10GΩ min.
- Working Temperature Range: -65°C to +150°C
- Resistance Value < 1Ω is available

Power Resistors



MTR Series

MERITEK

MTR50H

Dimensions

Type	Weight (g) (1000pcs)
MTR50-H	2770

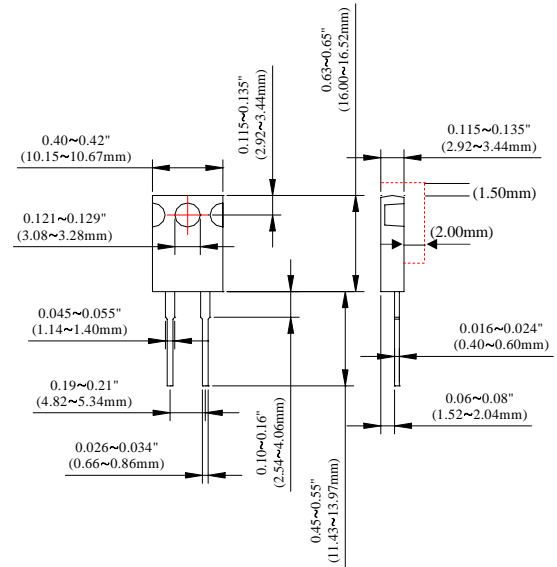

Derating Curve

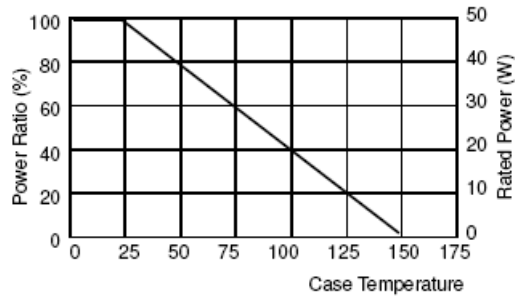

Electrical Characteristics Specifications

Item	Resistance Range				TCR (PPM/°C)
	±0.5%	±1%	±5%	±10%	
Type					
MTR50	-	-	0.1Ω -1Ω		
	-	-	>1Ω -3Ω		±300
	-	-	>3Ω -10Ω		±100 ±200
	-	-	>10Ω -10KΩ		±50 ±100 ±200

- Operating Voltage: 350V_{Max}
- Dielectric Strength: 1800V_{AC}
- Insulation Resistance: 10GΩ min.
- Working Temperature Range: -65°C to +150°C
- Resistance Value < 1Ω is available

Power Resistors



MTR Series

MERITEK

MTR100

Dimensions

Type	Weight (g) (1000pcs)
MTR100	3381

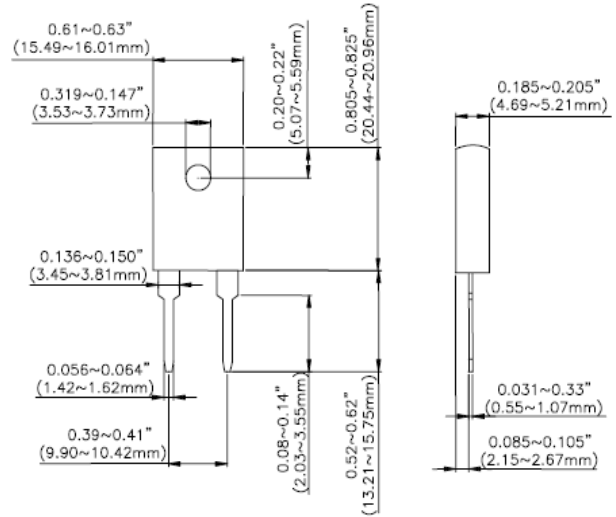

Derating Curve

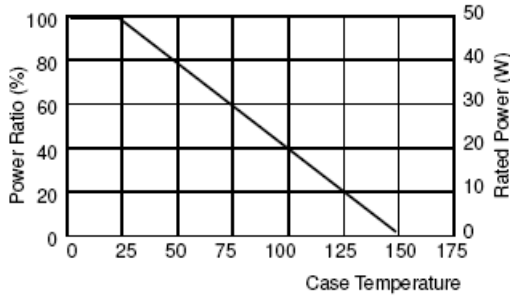

Electrical Characteristics Specifications

Item	Resistance Range			TCR (PPM/°C)
	±1%	±5%	±10%	
Type	-	0.05Ω -1Ω		
		>1Ω -3Ω		±300
		>3Ω -10Ω		±100 ±200
		>10Ω -10KΩ		±50 ±100 ±200

- Operating Voltage: 700V_{Max}
- Dielectric Strength: 1800V_{AC}
- Insulation Resistance: 10GΩ min.
- Working Temperature Range: -65°C to +175°C
- Resistance Value < 1Ω is available