

HiPerFAST™ IGBT with Diode C2-Class High Speed IGBTs

IXGK 50N60C2D1
IXGX 50N60C2D1

V_{CES} = 600 V
I_{C25} = 75 A
V_{CE(sat)} = 2.5 V
t_{fi(typ)} = 48 ns

Preliminary Data Sheet

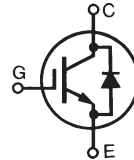

Symbol	Test Conditions	Maximum Ratings	
V _{CES}	T _J = 25°C to 150°C	600	V
V _{CGR}	T _J = 25°C to 150°C; R _{GE} = 1 MΩ	600	V
V _{GES}	Continuous	±20	V
V _{GEM}	Transient	±30	V
I _{C25}	T _C = 25°C (limited by leads)	75	A
I _{C110}	T _C = 110°C	50	A
I _{F110}	T _C = 110°C	48	A
I _{CM}	T _C = 25°C, 1 ms	300	A
SSOA (RBSOA)	V _{GE} = 15 V, T _{VJ} = 125°C, R _G = 10 Ω Clamped inductive load @ V _{CE} ≤ 600 V	I _{CM} = 100	A
P _C	T _C = 25°C	480	W
T _J		-55 ... +150	°C
T _{JM}		150	°C
T _{stg}		-55 ... +150	°C
M _d	Mounting torque, TO-264	1.13/10 Nm/lb.in.	
Weight	TO-264	10	g
	PLUS247	6	g
	Maximum lead temperature for soldering 1.6 mm (0.062 in.) from case for 10 s	300	°C

**TO-264 AA
(IXGK)**

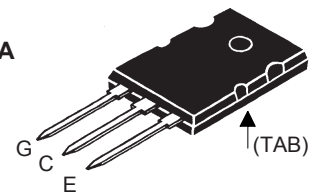

**PLUS247
(IXGX)**

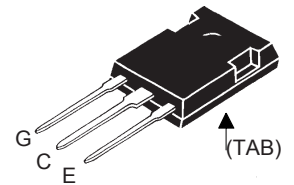

G = Gate C = Collector
E = Emitter Tab = Collector

Features

- Very high frequency IGBT and anti-parallel FRED in one package
- Square RBSOA
- High current handling capability
- MOS Gate turn-on for drive simplicity
- Fast Recovery Epitaxial Diode (FRED) with soft recovery and low I_{RM}

Applications

- Switch-mode and resonant-mode power supplies
- Uninterruptible power supplies (UPS)
- DC choppers
- AC motor speed control
- DC servo and robot drives

Advantages

- Space savings (two devices in one package)
- Easy to mount with 1 screw

Symbol	Test Conditions	Characteristic Values (T _J = 25°C, unless otherwise specified)		
		Min.	Typ.	Max.
V _{GE(th)}	I _C = 250 μA, V _{CE} = V _{GE}	3.0		5.0 V
I _{CES}	V _{CE} = V _{CES} V _{GE} = 0 V			650 μA 5 mA
I _{GES}	V _{CE} = 0 V, V _{GE} = ±20 V			±100 nA
V _{CE(sat)}	I _C = 40 A, V _{GE} = 15 V Note 1		2.1 1.8	2.5 V V

Symbol	Test Conditions	Characteristic Values			
		$(T_J = 25^\circ\text{C}, \text{ unless otherwise specified})$			
		Min.	Typ.	Max.	
g_{fs}	$I_C = 40 \text{ A}; V_{CE} = 10 \text{ V}$, Note 1	40	51	S	
C_{ies}	$V_{CE} = 25 \text{ V}, V_{GE} = 0 \text{ V}, f = 1 \text{ MHz}$		3700	pF	
C_{oes}			290	pF	
C_{res}			50	pF	
Q_g	$I_C = 40 \text{ A}, V_{GE} = 15 \text{ V}, V_{CE} = 0.5 V_{CES}$		138	nC	
Q_{ge}			25	nC	
Q_{gc}			40	nC	
$t_{d(on)}$	Inductive load, $T_J = 25^\circ\text{C}$ $I_C = 40 \text{ A}, V_{GE} = 15 \text{ V}$ $V_{CE} = 480 \text{ V}, R_G = R_{off} = 2.0 \Omega$		18	ns	
t_{ri}			25	ns	
$t_{d(off)}$			115	150	ns
t_{fi}			48	ns	
E_{off}			0.38	0.7	mJ
$t_{d(on)}$	Inductive load, $T_J = 125^\circ\text{C}$ $I_C = 40 \text{ A}, V_{GE} = 15 \text{ V}$ $V_{CE} = 480 \text{ V}, R_G = R_{off} = 2.0 \Omega$		18	ns	
t_{ri}			25	ns	
E_{on}			1.4	mJ	
$t_{d(off)}$			170	ns	
E_{off}			0.74	mJ	
R_{thJC}			0.31	KW	
R_{thCK}		0.15		KW	

Reverse Diode (FRED)		Characteristic Values		
		$(T_J = 25^\circ\text{C}, \text{ unless otherwise specified})$		
Symbol	Test Conditions	min.	typ.	max.
V_F	$I_F = 60 \text{ A}, V_{GE} = 0 \text{ V}$, Note 1			2.1 V
				$T_J = 150^\circ\text{C}$ 1.4
I_{RM}	$I_F = 60 \text{ A}, V_{GE} = 0 \text{ V}, -di_F/dt = 100 \text{ A}/\mu\text{s}$ $V_R = 100 \text{ V}$			8.3 A
t_{rr}	$I_F = 1 \text{ A}; -di/dt = 200 \text{ A/ms}; V_R = 30 \text{ V}$		35	ns
R_{thJC}				0.65 KW

Note 1: Pulse test, $t \leq 300 \mu\text{s}$, duty cycle $\leq 2\%$

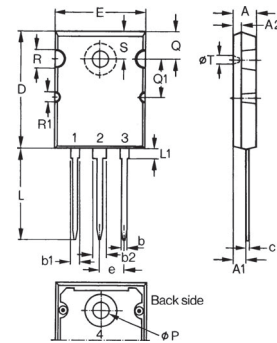
TO-264 AA Outline

Dim.	Millimeter		Inches	
	Min.	Max.	Min.	Max.
A	4.82	5.13	.190	.202
A1	2.54	2.89	.100	.114
A2	2.00	2.10	.079	.083
b	1.12	1.42	.044	.056
b1	2.39	2.69	.094	.106
b2	2.90	3.09	.114	.122
c	0.53	0.83	.021	.033
D	25.91	26.16	1.020	1.030
E	19.81	19.96	.780	.786
e	5.46BSC		.215BSC	
J	0.00	0.25	.000	.010
K	0.00	0.25	.000	.010
L	20.32	20.83	.800	.820
L1	2.29	2.59	.090	.102
P	3.17	3.66	.125	.144
Q	6.07	6.27	.239	.247
Q1	8.38	8.69	.330	.342
R	3.81	4.32	.150	.170
R1	1.78	2.29	.070	.090
S	6.04	6.30	.238	.248
T	1.57	1.83	.062	.072

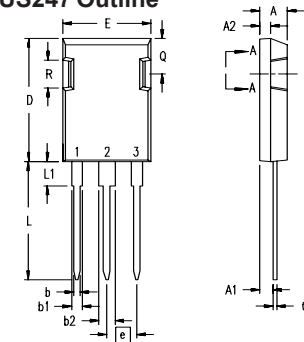
PLUS247 Outline

Terminals: 1 - Gate
 2 - Drain (Collector)
 3 - Source (Emitter)
 4 - Drain (Collector)

Dim.	Millimeter		Inches	
	Min.	Max.	Min.	Max.
A	4.83	5.21	.190	.205
A ₁	2.29	2.54	.090	.100
A ₂	1.91	2.16	.075	.085
b	1.14	1.40	.045	.055
b ₁	1.91	2.13	.075	.084
b ₂	2.92	3.12	.115	.123
C	0.61	0.80	.024	.031
D	20.80	21.34	.819	.840
E	15.75	16.13	.620	.635
e	5.45 BSC		.215 BSC	
L	19.81	20.32	.780	.800
L1	3.81	4.32	.150	.170
Q	5.59	6.20	.220	0.244
R	4.32	4.83	.170	.190

IXYS reserves the right to change limits, test conditions, and dimensions.

Fig. 1. Output Characteristics
@ 25 Deg. C

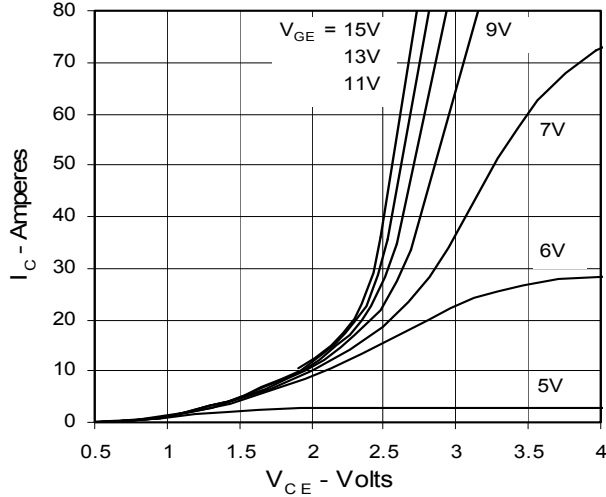

Fig. 2. Extended Output Characteristics
@ 25 deg. C

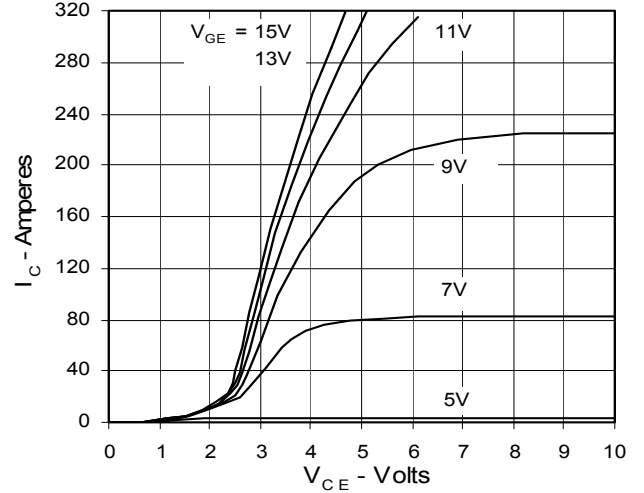

Fig. 3. Output Characteristics
@ 125 Deg. C

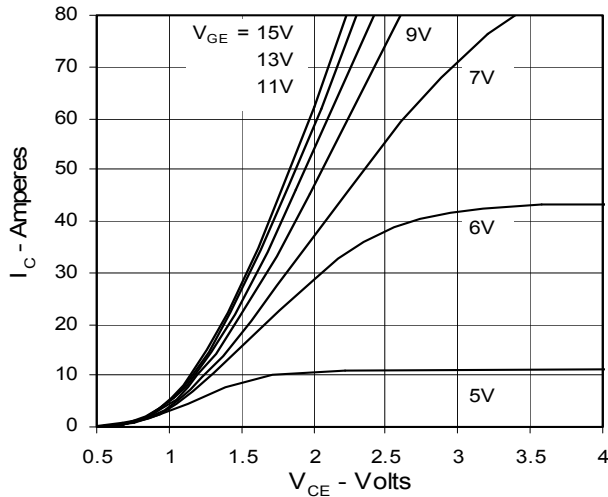

Fig. 4. Dependence of $V_{CE(sat)}$ on Temperature

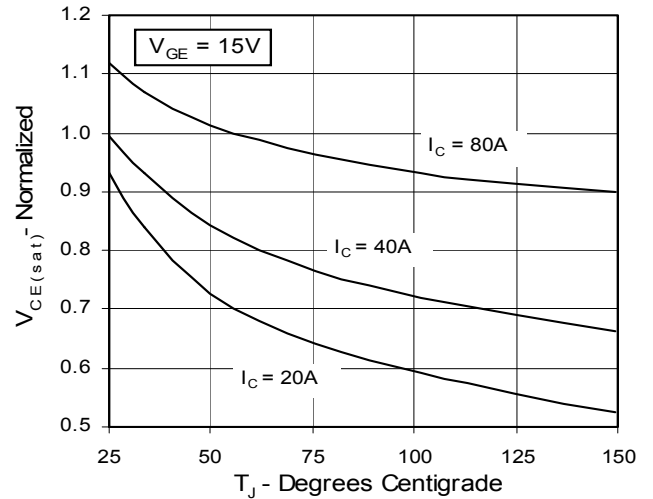

Fig. 5. Collector-to-Emitter Voltage vs. Gate-to-Emitter voltage

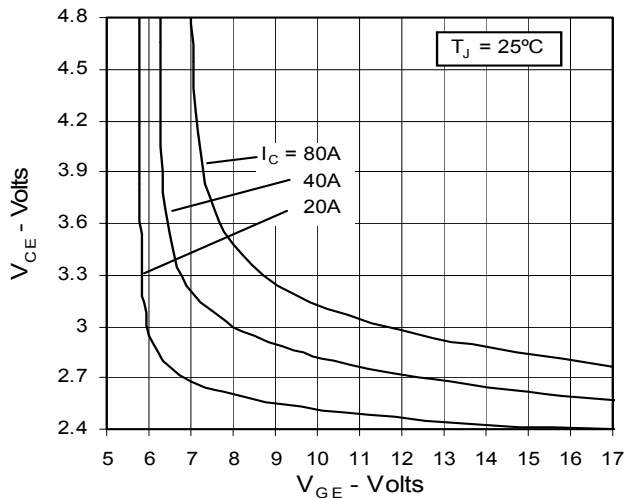

Fig. 6. Input Admittance

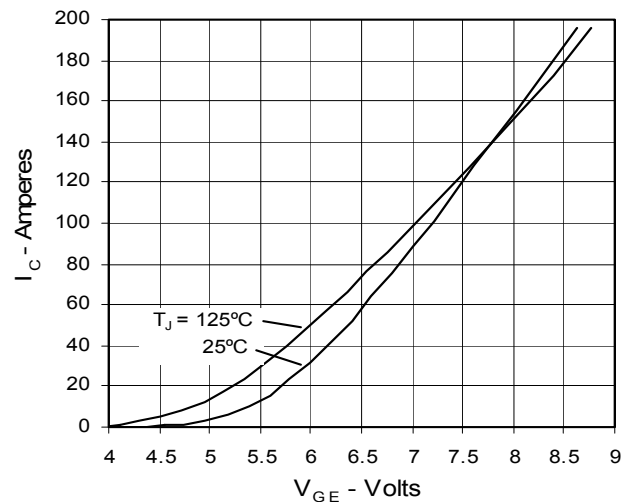

Fig. 7. Transconductance

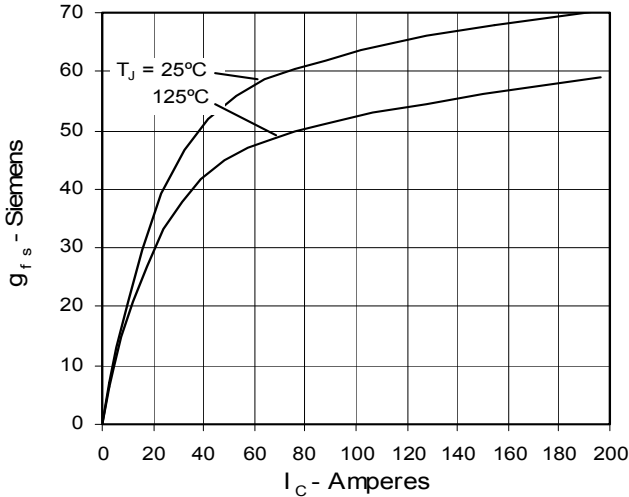

Fig. 8. Dependence of Turn-Off Energy on R_G

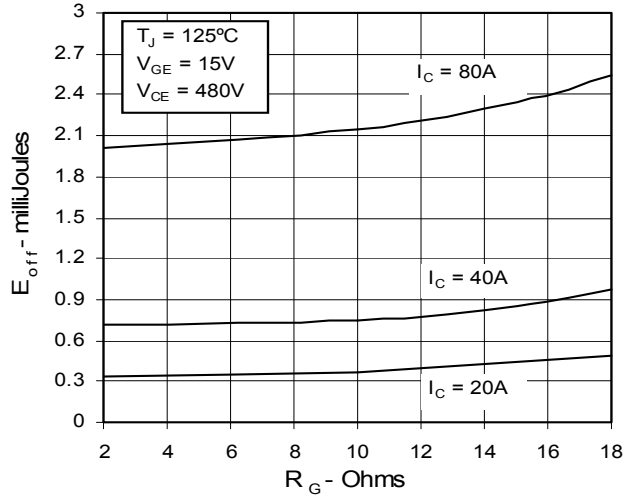

Fig. 9. Dependence of Turn-Off Energy on I_C

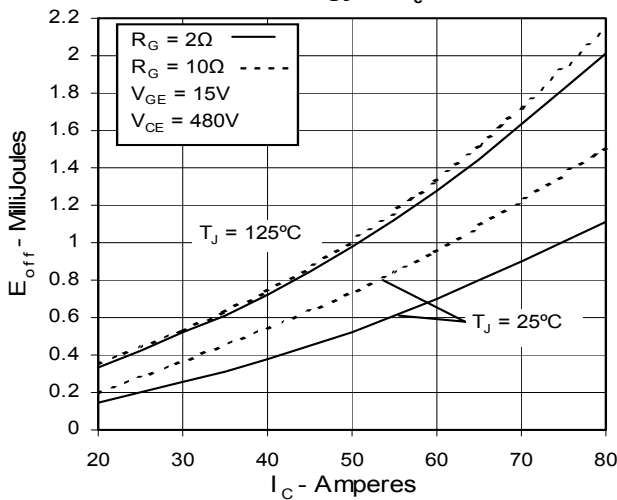

Fig. 10. Dependence of Turn-Off Energy on Temperature

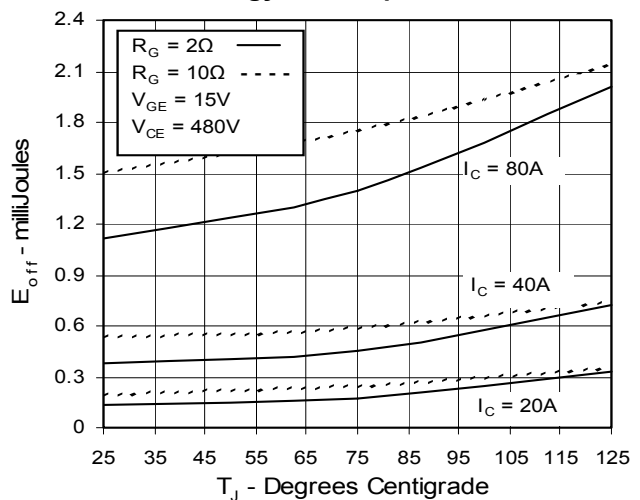

Fig. 11. Dependence of Turn-Off Switching Time on R_G

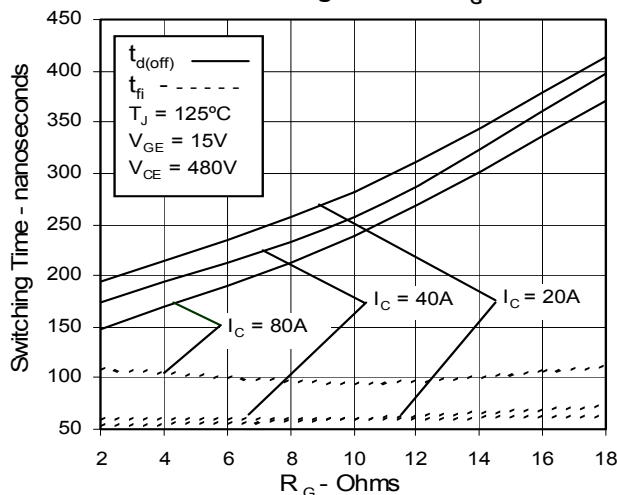

Fig. 12. Dependence of Turn-Off Switching Time on I_C

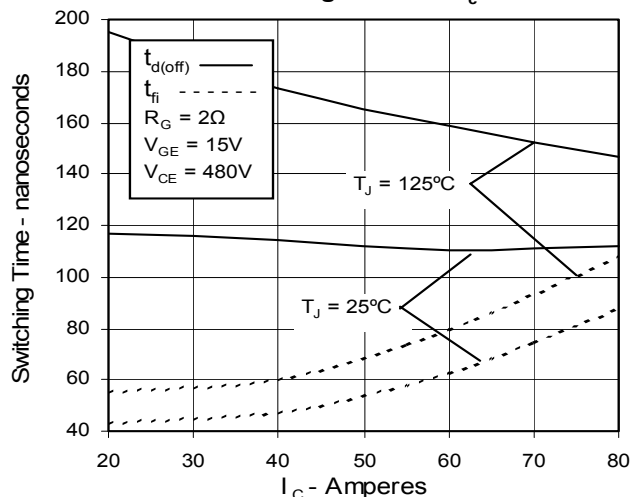

Fig. 13. Dependence of Turn-Off Switching Time on Temperature

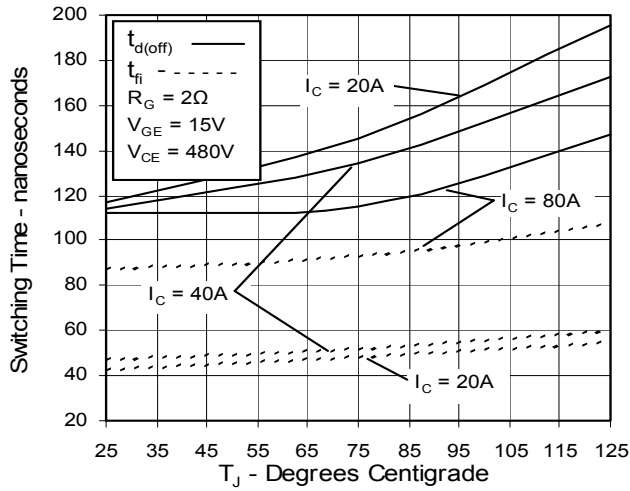

Fig. 14. Reverse-Bias Safe Operating Area

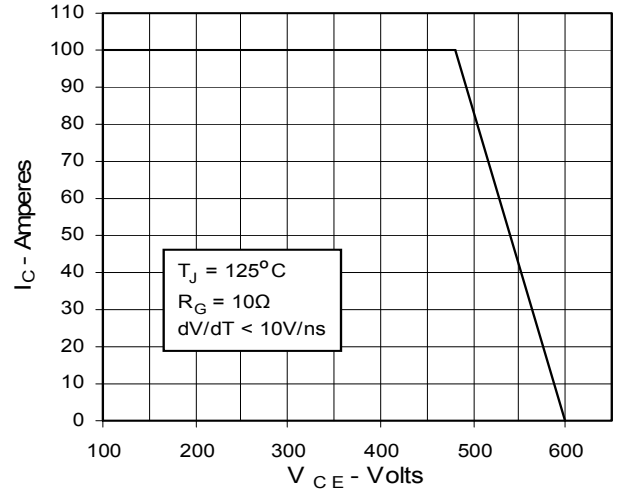

Fig. 15. Gate Charge

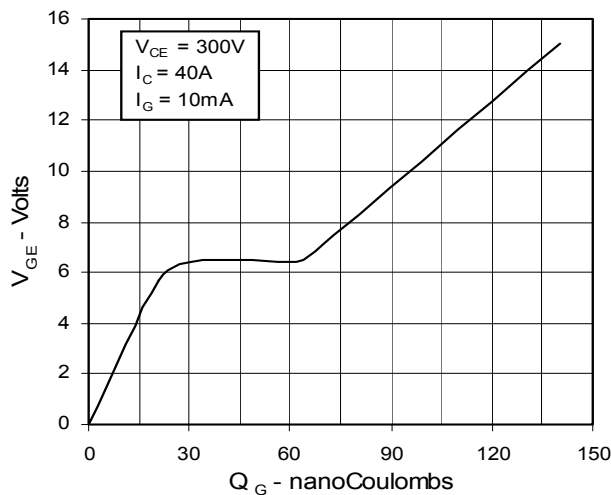

Fig. 16. Capacitance

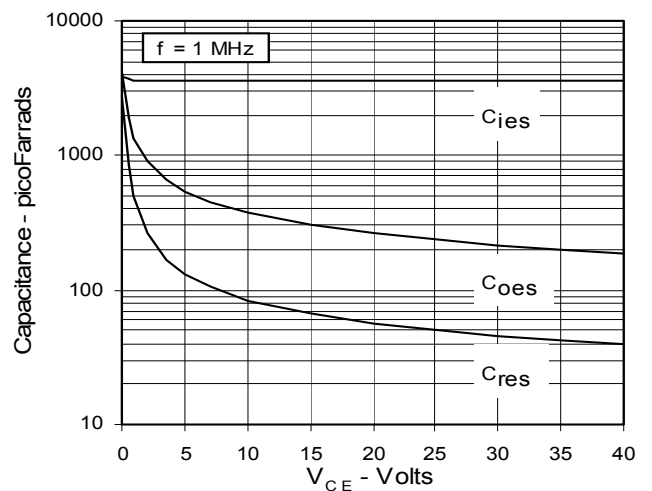
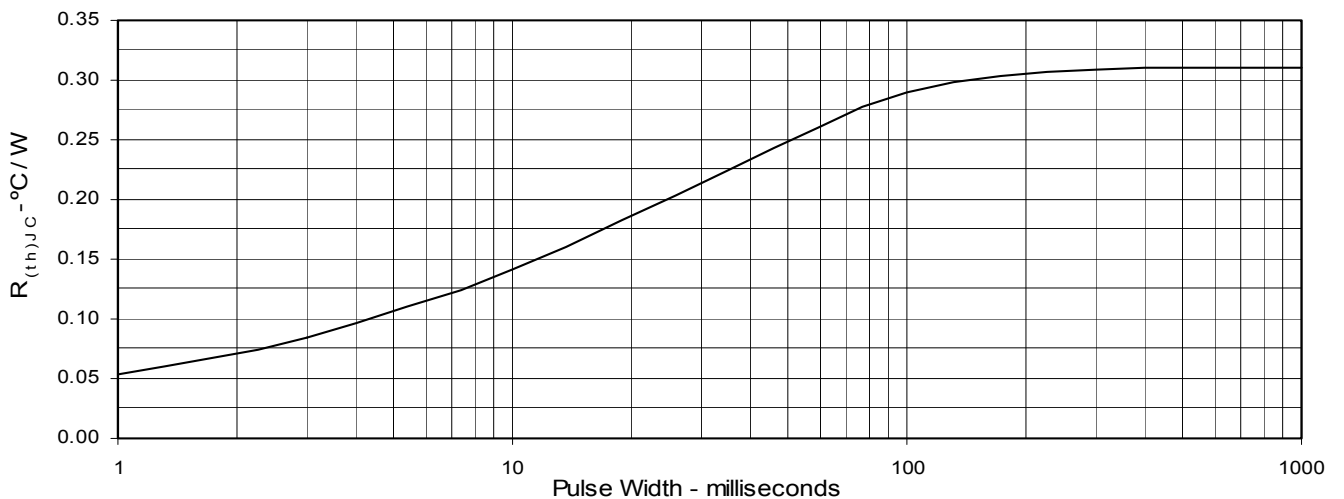

Fig. 16. Maximum Transient Thermal Resistance



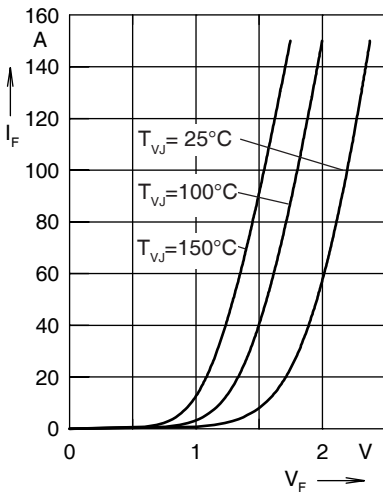

Fig. 17. Forward current I_F versus V_F

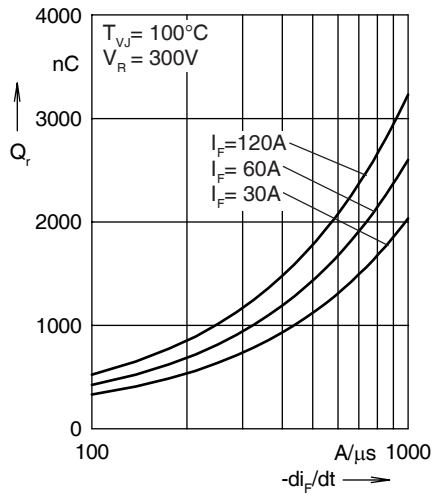

Fig. 18. Reverse recovery charge Q_r versus $-di_F/dt$

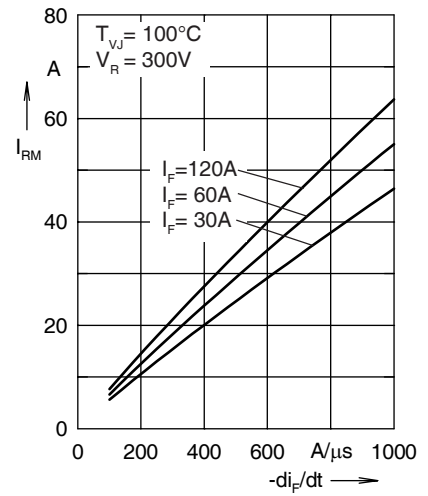

Fig. 19. Peak reverse current I_{RM} versus $-di_F/dt$

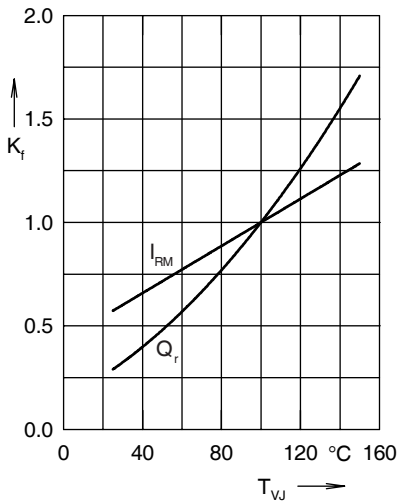

Fig. 20. Dynamic parameters Q_r , I_{RM} versus T_{VJ}

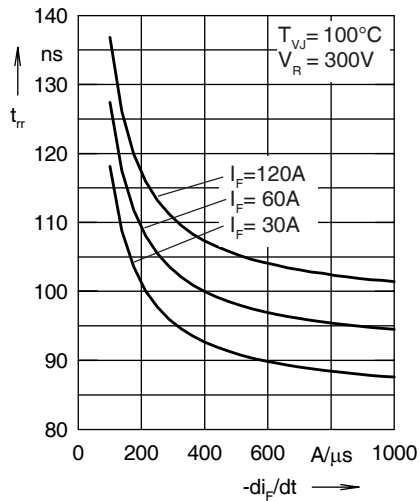

Fig. 21. Recovery time t_{rr} versus $-di_F/dt$

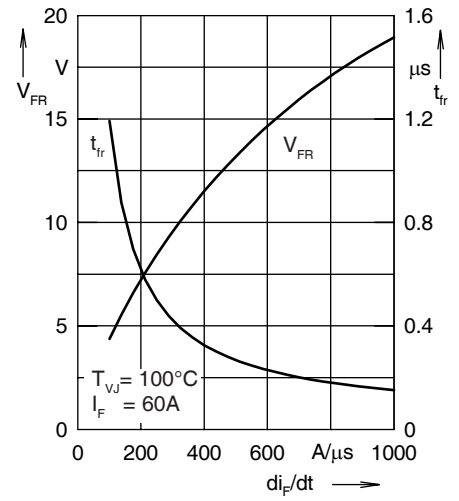

Fig. 22. Peak forward voltage V_{FR} and t_{tr} versus di_F/dt

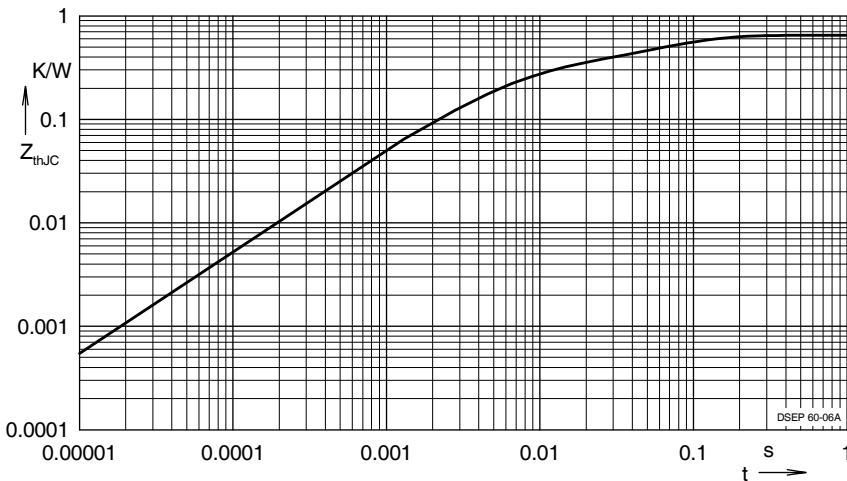

Fig. 23. Transient thermal resistance junction to case

Constants for Z_{thJC} calculation:

i	R_{thi} (K/W)	t_i (s)
1	0.324	0.0052
2	0.125	0.0003
3	0.201	0.0385

Note: Fig. 2 through Fig. 6 show typical values