

### Features

- High Luminous LEDs
- 3mm Round Standard Directivity
- Superior Weather-resistance
- UV Resistant Epoxy
- Water Clear Type

### Applications

- Traffic Signal
- Backlighting
- Signal and channel letter
- Other Lighting

### Outline Dimension

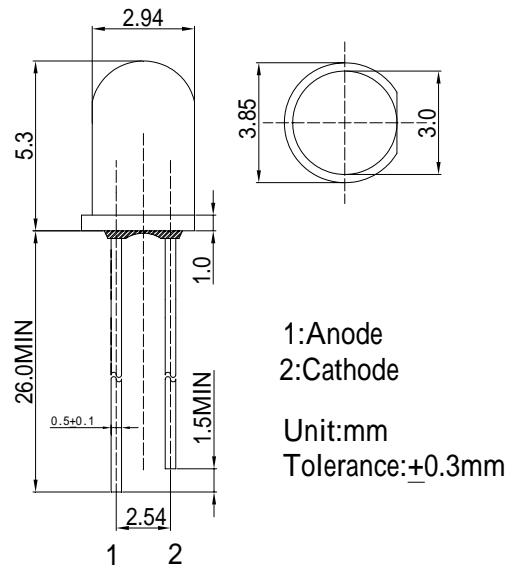

### Absolute Maximum Rating

(Ta=25 )

Item	Symbol	Value	Unit
DC Forward Current	$I_F$	50	mA
Pulse Forward Current*	$I_{FP}$	120	mA
Reverse Voltage	$V_R$	5	V
Power Dissipation	$P_D$	120	mW
Operating Temperature	$T_{opr}$	-30 ~ +85	
Storage Temperature	$T_{stg}$	-40 ~ +100	
Lead Soldering Temperature	$T_{sol}$	260 / 5sec	-

\*Pulse width Max.10ms Duty ratio max 1/10

### Directivity

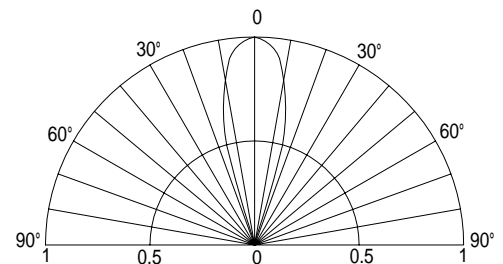

### Electrical -Optical Characteristics

(Ta=25 )

Item	Symbol	Condition	Min.	Typ.	Max.	Unit
DC Forward Voltage	$V_F$	$I_F=20mA$	1.8	2.1	2.4	V
DC Reverse Current	$I_R$	$V_R=5V$	-	-	10	$\mu A$
Domi. Wavelength*	$\lambda_D$	$I_F=20mA$	600	605	610	nm
Luminous Intensity*	$I_v$	$I_F=20mA$	-	8000	-	mcd
50% Power Angle	$2\theta_{1/2}$	$I_F=20mA$	-	30	-	deg

\*1 Tolerance of dominant wavelength is  $\pm 1nm$

\*2 Tolerance of luminous intensity is  $\pm 15\%$

### Maximum Forward Current

Maximum Permissible Forward Current  $T_J=115^\circ C$

