

# **LIGHTTEL**

**TECHNOLOGIES INC.**

## **CW-5000 Coupler Workstation**



***A Versatile Workstation Platform  
for Fiber Processing***

**[www.lighttel.com](http://www.lighttel.com)**

***Lightel Technologies Inc***

## Overview

The Lightel CW-5000 workstation allows fabricating a wide range of fused fiber optic products, including biconic fused couplers, fiber tapers, bundles, and various fiber processing. Its optional platform structure and intelligent automatic control, make this workstation a highly useful machine for fiber-fusion related manufacturing and research.

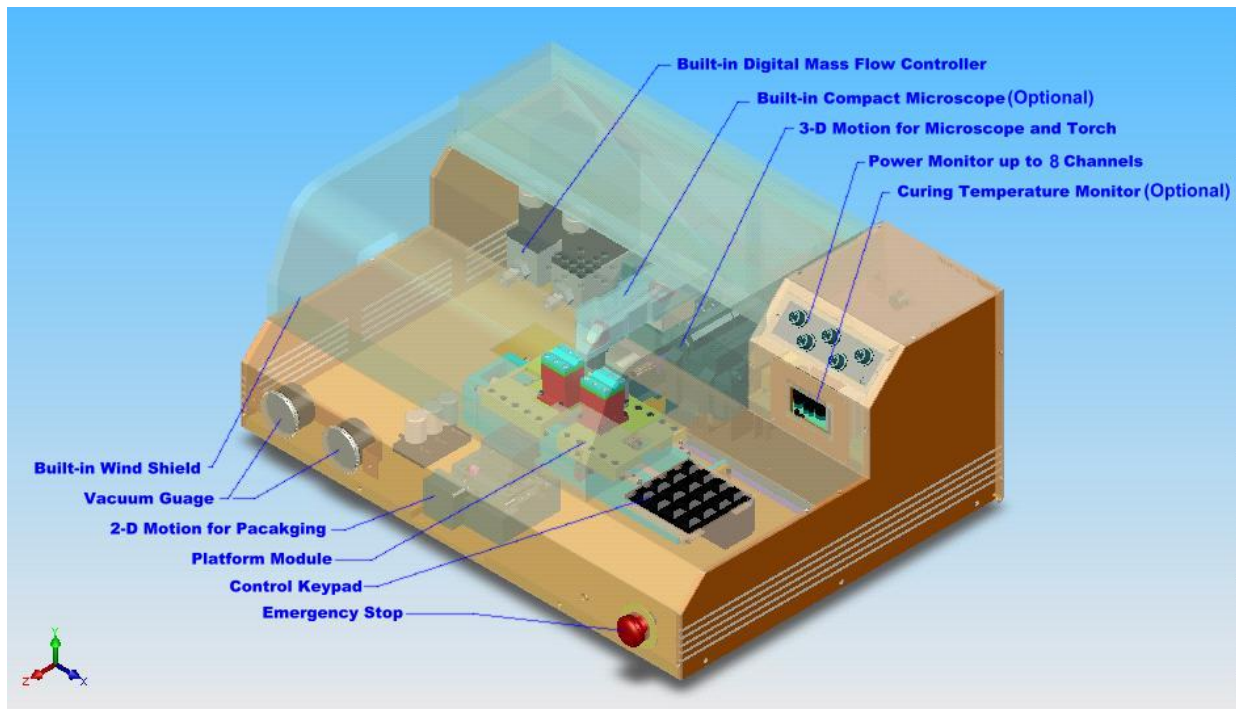

## Hardware and standard features

- High precision motor control, up to 8 motors
- Optional position encoder to maintain required speed or required positioning
- 16 bit A/D conversion, monitoring up to 8 channels of optical power
- 3-D camera/torch motion mechanism
- Built-in Hydrogen and Oxygen (optional) mass flow controller
- Built-in curing temperature monitor/controller
- Optional Video microscope for advanced applications such as PM fiber orientation, fiber cleanliness checking, fiber alignment, etc
- Optional internal Oxygen mixer or external Oxygen nozzle
- Wide selection of optional accessories

[www.lightel.com](http://www.lightel.com)

**Lightel Technologies Inc.**

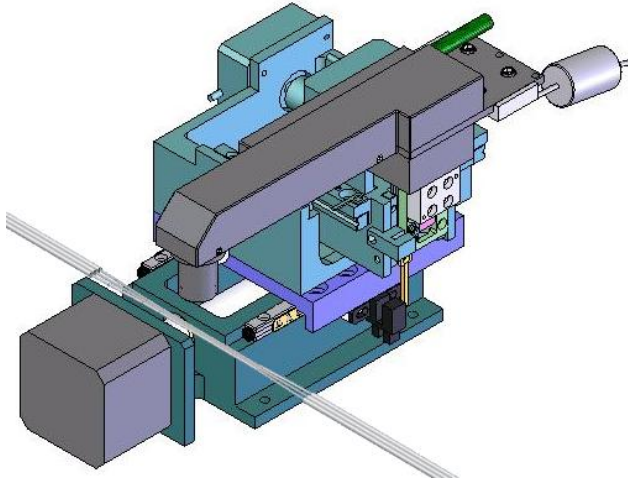

## Built-in microscope

The CW-5000 contains a compact microscope with 3D motion for feeding, focusing & scanning, ideal for checking fiber cleanliness, fiber alignment, PM fiber orientation and other parameters. The 2 megapixel CMOS detector allows capturing of high resolution images. The software saves captured images into a designated folder. A digital zooming function is available when needed.

## Epoxy curing temperature Monitor/Controller

The CW-5000 includes a 2-channel curing temperature controlling/monitoring system. Users can pre-program a defined epoxy curing temperature profile. The built-in thermocouples and the closed-loop feedback allow a curing control, ensuring an ideal curing result.



## Interchangeable Torch nozzle



A full line of hydrogen torch nozzles are available (from 4mm to 14mm). They can be easily interchanged by the user.

CW-5000 also offers an external Oxygen diffuser to help achieving a higher temperature when needed; for example, when fusing multiple fibers or large-diameter fibers.

[www.lightel.com](http://www.lightel.com)

**Lightel Technologies Inc.**

## Software Features

- Windows based application, allows users to visually monitor the real-time evolution of the coupling ratio and insertion loss, offers an option for automatic manufacturing statistics
- Smart Gas flow control, programmable Hydrogen and/or Oxygen flow rate setting automatically adjust gas flow rate during fusion, combined with other programmable parameters such as pulling speed, scan speed, allows user to precisely control the fusion temperature. This is a very useful feature for up-to-date technologies such as fiber tapering, multi-fiber fusion, etc.
- An optional compact video microscope with 3-D adjustment, allows fiber checking before or after fusion. The camera's 3-D motion is controlled by software and quick keys.
- Dedicated image capturing utility readily saves images to designated folders
- This highly flexible and programmable software allows users to program their own process, such as variable pulling speed, variable scan mode/scan speed, and variable gas flow. This is ideal for new product development and lab research.
- Intelligent pulling control: Pulling parameters can be automatically adjusted based on the pulling results.
- Curing temperature monitoring, close-loop feedback and control for thermal epoxy cure
- Save fabrication parameters and specifications by part/model number for easy recall
- Database automatically records all measured data and pre-set parameters. This is very important for process evaluation and manufacturing management (including yield statistics, profit/cost analysis etc.). Records can be easily retrieved by date, part number or operator number.
- Network-ready remote database and server console software (optional) provide a useful supervisory tool for production monitoring and reporting.

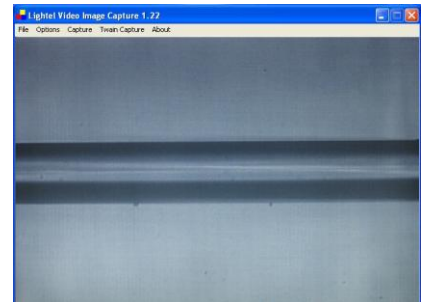
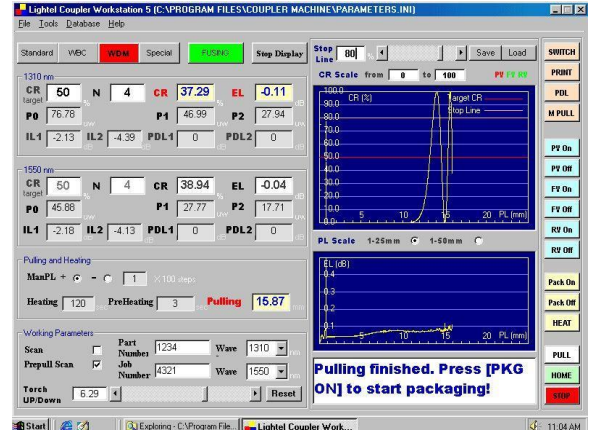

[www.lighttel.com](http://www.lighttel.com)

**Lightel Technologies Inc.**

## Configurations and applications

The modularized design of the CW-5000 allows the machine highly flexible for different applications. Six interchangeable platforms can cover most current fused fiber applications. Lightel can design/build custom workstations based special requirements.

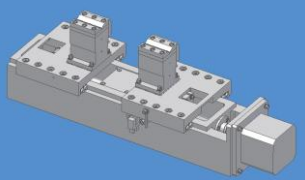
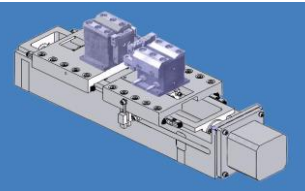
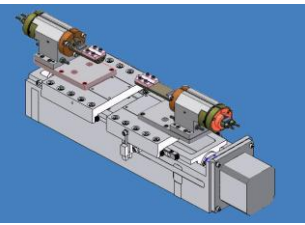
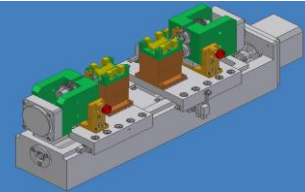
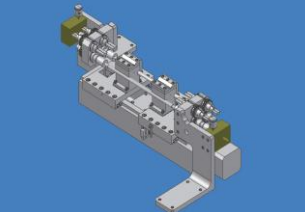
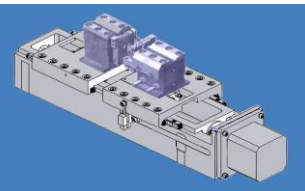
<p><b>Base Platform</b></p>	<p>For processing of 1~2 fibers, including 1x2, 2x2 coupler fabrication (using fiber twisting approach), as well as various single fiber processing applications</p>	
<p><b>Base Plus (Parallel) Platform</b></p>	<p>A parallel fixture is added to the Base Platform to allow coupler fabrications using parallel fiber approach, configurable for 1x2, 2x2, 1x3. All functions of the Base model are included in Base Plus.</p>	
<p><b>Rotation Platform</b></p>	<p>A pair of manual rotators is added to the Base Platform for fiber rotation after fusion (to improve coupler performance, such as the WDM coupler channel-isolation, etc.). All functions of the Base model are included in Rotation Platform.</p>	
<p><b>PM Platform</b></p>	<p>A special platform for PM products. It includes two additional motors for PM fiber orientation alignment as well as special software control.</p>	
<p><b>Fused Fiber Bundle Platform</b></p>	<p>Handle up to 7 fibers, ideal for fiber bundle combiner fabrication. Consult with Lightel sales representative for more information.</p>	
<p><b>1x4 Platform</b></p>	<p>Dedicated workstation to low-cost and high reliability 1x4 single-fusion couplers. Handles 4 or 5 fibers.</p>	

[www.lightel.com](http://www.lightel.com)

**Lightel Technologies Inc.**



# CW-5000 Specifications

## Overall

Dimensions	21.65" x 16" x 9.65" (550 x 405 x 245mm)
Weight	Approximate 70lb (31.5kg)
Power	100-240V, 50/60hz, 150Watt

## Gas

Hydrogen	99.96% purity, minimal pressure before MFC: 20PSI, consumption: 180sccm
Oxygen (Optional)	Consumption: 20-150sccm, depending on applications
MFC	Digital Controlled via RS232, Flow Rate: 0-300SCCM

## Motor/Driver

Motion Control Board	PCI Universal, 266Mhz, 32-Bit RISC processor, 6 or 8 Axes
Pulling Motor/Driver	5 Phase, 0.75A/Phase, 125,000 step resolution, 25oz/in holding torque
Torch F/B Motor/Driver	5 Phase, 0.75A/Phase, 5,000 step resolution, Max 18.4oz/in holding torque
Rotation Motor (Optional)	5 Phase, 0.35A/Phase, 5,000 step resolution, Max 12.5oz/in holding torque
Other Motors (Slim)	4 Phase, 0.21A/Phase, 4000 step resolution, Max 7.3oz/in holding Torque

## Power Monitor

Photodiode	Diameter 1mm, Responsivity 0.12A/W@800nm, 0.85A/W@1550nm
A/D Conversion	PCI Universal, 16Bit resolution, 16 Channel (8 Ch Differential), +/-10V input

## Mechanical

Drive	Lead Screw Drive, Self-Lubricating Super-Nuts
Pulling Stage Travel	Standard Travel Distance: 50mm (Optional 90mm), 0.0127mm/Step
Torch F/B Travel	Standard Travel Distance: 36mm, 0.0318mm/Step
Torch/Microscope Scan	Standard Travel Distance: 23mm, (50mm Optional). 0.16mm/Step
Torch U/D Stage	Standard Travel Distance: 12mm, 0.0318mm/Step
Package F/B Travel	Standard Travel Distance: 23mm, 0.0318mm/Step
Package U/D Stage	Standard Travel Distance: 12mm, 0.0318mm/Step

## Microscope

Optical Lenses	Microscope Objective Lenses, 10x, 0.25NA
Sensor	1/3" CMOS Approximate 2 MP
Display	Included PC monitor

[www.lightel.com](http://www.lightel.com)

**Lightel Technologies Inc.**