

EVALUATION KIT
AVAILABLE

MAXIM

10-Bit, 60Msps, 3.0V, Low-Power ADC with Internal Reference

MAX1446

General Description

The MAX1446 10-bit, 3V analog-to-digital converter (ADC) features a fully differential input, a pipelined 10-stage ADC architecture with digital error correction and wideband track and hold (T/H) incorporating a fully differential signal path. This ADC is optimized for low-power, high dynamic performance applications in imaging and digital communications. The MAX1446 operates from a single 2.7V to 3.6V supply, consuming only 90mW while delivering a 59.5dB signal-to-noise ratio (SNR) at a 20MHz input frequency. The fully differential input stage has a 400MHz, -3dB bandwidth and may be operated with single-ended inputs. In addition to low operating power, the MAX1446 features a 5 μ A power-down mode for idle periods.

An internal 2.048V precision bandgap reference is used to set the ADC full-scale range. A flexible reference structure allows the user to supply a buffered, direct or externally derived reference for applications requiring increased accuracy or a different input voltage range.

Lower and higher speed, pin-compatible versions of the MAX1446 are also available. Refer to the MAX1444 data sheet for a 40Msps version, the MAX1448 data sheet for an 80Msps version, and the MAX1449 data sheet for a 105Msps version.

The MAX1446 has parallel, offset binary, three-state outputs that can be operated from 1.7V to 3.3V to allow flexible interfacing. The device is available in a 5mm x 5mm, 32-pin TQFP package and is specified over the extended industrial (-40°C to +85°C) and automotive (-40°C to +105°C) temperature ranges.

Applications

- Ultrasound Imaging
- CCD Imaging
- Baseband and IF Digitization
- Digital Set-Top Boxes
- Video Digitizing Applications

Pin-Compatible, Lower/Higher Speed Versions

| PART | SAMPLING SPEED (Msps) |
|---------|-----------------------|
| MAX1444 | 40 |
| MAX1448 | 80 |
| MAX1449 | 105 |

Features

- ◆ Single 3.0V Operation
- ◆ Excellent Dynamic Performance
 - 59.5dB SNR at $f_{IN} = 20\text{MHz}$
 - 73dB SFDR at $f_{IN} = 20\text{MHz}$
- ◆ Low Power:
 - 30mA (Normal Operation)
 - 5 μ A (Shutdown Mode)
- ◆ Fully Differential Analog Input
- ◆ Wide 2V_{p-p} Differential Input Voltage Range
- ◆ 400MHz -3dB Input Bandwidth
- ◆ On-Chip 2.048V Precision Bandgap Reference
- ◆ CMOS-Compatible Three-State Outputs
- ◆ 32-Pin TQFP Package
- ◆ Evaluation Kit Available (MAX1448 EV Kit)

Ordering Information

| PART | TEMP RANGE | PIN-PACKAGE |
|-------------|-----------------|-------------|
| MAX1446EHJ+ | -40°C to +85°C | 32 TQFP |
| MAX1446GHJ+ | -40°C to +105°C | 32 TQFP |

+ Denotes a lead(Pb)-free/RoHS-compliant package.

Functional Diagram

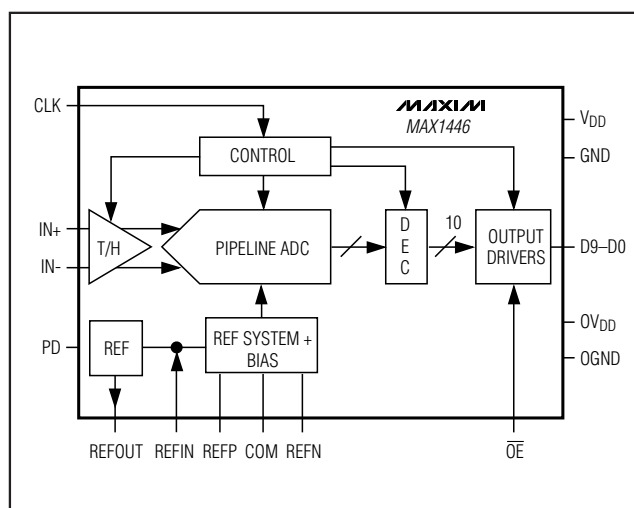

MAXIM

Maxim Integrated Products 1

For pricing, delivery, and ordering information, please contact Maxim Direct at 1-888-629-4642, or visit Maxim's website at www.maxim-ic.com.

10-Bit, 60Msps, 3.0V, Low-Power ADC with Internal Reference

ABSOLUTE MAXIMUM RATINGS

| | |
|--|------------------------------------|
| V _{DD} , OV _{DD} to GND | -0.3V to +3.6V |
| OGND to GND | -0.3V to +0.3V |
| IN+, IN- to GND | -0.3V to V _{DD} |
| REFIN, REFOUT, REFP, REFN, and COM to GND | -0.3V to (V _{DD} + 0.3V) |
| OE, PD, CLK to GND | -0.3V to (V _{DD} + 0.3V) |
| D9–D0 to GND | -0.3V to (OV _{DD} + 0.3V) |

| | |
|---|-----------------|
| Continuous Power Dissipation (T _A = +70°C) 32-Pin TQFP (derate 18.7mW/°C above +70°C) | 1495.3mW |
| Operating Temperature Ranges: | |
| MAX1446EHJ+ | -40°C to +85°C |
| MAX1446GHJ+ | -40°C to +105°C |
| Storage Temperature Range | -60°C to +150°C |
| Lead Temperature (soldering, 10s) | +300°C |

Stresses beyond those listed under "Absolute Maximum Ratings" may cause permanent damage to the device. These are stress ratings only, and functional operation of the device at these or any other conditions beyond those indicated in the operational sections of the specifications is not implied. Exposure to absolute maximum rating conditions for extended periods may affect device reliability.

ELECTRICAL CHARACTERISTICS

(V_{DD} = 3.0V, OV_{DD} = 2.7V; 0.1μF and 1.0μF capacitors from REFP, REFN, and COM to GND; V_{REFIN} = 2.048V, REFOUT connected to REFIN through a 10kΩ resistor, V_{IN} = 2V_{P-P} (differential with respect to COM), C_L ≈ 10pF at digital outputs, f_{CLK} = 62.5MHz (50% duty cycle), T_A = T_{MIN} to T_{MAX}, unless otherwise noted. ≥+25°C guaranteed by production test, < +25°C guaranteed by design and characterization. Typical values are at T_A = +25°C.)

| PARAMETER | SYMBOL | CONDITIONS | MIN | TYP | MAX | UNITS |
|--|-------------------|--|------|-----------------------------|------|--------|
| DC ACCURACY | | | | | | |
| Resolution | | | 10 | | | Bits |
| Integral Nonlinearity | INL | f _{IN} = 7.492MHz, T _A ≥ +25°C | | ±0.6 | ±1.9 | LSB |
| Differential Nonlinearity | DNL | No missing codes, f _{IN} = 7.492MHz | | ±0.4 | ±1.0 | LSB |
| Offset Error | | | -1.6 | < ±0.1 | ±1.9 | % FS |
| Gain Error | | T _A ≥ +25°C | | 0 | ±2.0 | % FS |
| ANALOG INPUT | | | | | | |
| Input Differential Range | V _{DIFF} | Differential or single-ended inputs | | ±1.0 | | V |
| Common-Mode Voltage Range | V _{COM} | | | V _{DD} /2 ± 0.5 | | V |
| Input Resistance | R _{IN} | Switched capacitor load | | 33 | | kΩ |
| Input Capacitance | C _{IN} | | | 5 | | pF |
| CONVERSION RATE | | | | | | |
| Maximum Clock Frequency | f _{CLK} | | 60 | | | MHz |
| Data Latency | | | | 5.5 | | Cycles |
| DYNAMIC CHARACTERISTICS | | | | | | |
| Signal-to-Noise Ratio | SNR | f _{IN} = 7.492MHz | 57 | 59.5 | | dB |
| | | f _{IN} = 19.943MHz | 56.5 | 59.5 | | |
| | | f _{IN} = 39.9MHz (Note 1) | | 59 | | |
| Signal-to-Noise + Distortion (Up to 5th Harmonic) | SINAD | f _{IN} = 7.492MHz | 56.6 | 59.4 | | dB |
| | | f _{IN} = 19.943MHz | 56.2 | 59 | | |
| | | f _{IN} = 39.9MHz (Note 1) | | 58.5 | | |
| Spurious-Free Dynamic Range | SFDR | f _{IN} = 7.492MHz | 65 | 74 | | dBc |
| | | f _{IN} = 19.943MHz | 63 | 73 | | |
| | | f _{IN} = 39.9MHz (Note 1) | | 71 | | |

10-Bit, 60Mps, 3.0V, Low-Power ADC with Internal Reference

MAX1446

ELECTRICAL CHARACTERISTICS (continued)

($V_{DD} = 3.0V$, $OV_{DD} = 2.7V$; $0.1\mu F$ and $1.0\mu F$ capacitors from REFP, REFN, and COM to GND; $V_{REFIN} = 2.048V$, REFOUT connected to REFIN through a $10k\Omega$ resistor, $V_{IN} = 2V_{P-P}$ (differential with respect to COM), $C_L \approx 10pF$ at digital outputs, $f_{CLK} = 62.5MHz$ (50% duty cycle), $T_A = T_{MIN}$ to T_{MAX} , unless otherwise noted. $\geq +25^\circ C$ guaranteed by production test, $< +25^\circ C$ guaranteed by design and characterization. Typical values are at $T_A = +25^\circ C$.)

| PARAMETER | SYMBOL | CONDITIONS | MIN | TYP | MAX | UNITS |
|---|------------------|--|------|--------------------|------|-----------------|
| Third-Harmonic Distortion | HD3 | $f_{IN} = 7.492MHz$ | | -74 | | dBc |
| | | $f_{IN} = 19.943MHz$ | | -73 | | |
| | | $f_{IN} = 39.9MHz$ (Note 1) | | -71 | | |
| Two-Tone Intermodulation Distortion | IMDTT | $f_1 = 19MHz$ at -6.5dBFS, $f_2 = 21MHz$ at -6.5dBFS (Note 2) | | -75 | | dBc |
| Third-Order Intermodulation Distortion | IM3 | $f_1 = 19MHz$ at -6.5dBFS $f_2 = 21MHz$ at -6.5dBFS (Note 2) | | -75 | | dBc |
| Total Harmonic Distortion (First 5 Harmonics) | THD | $f_{IN} = 7.492MHz$ | | -70 | -64 | dBc |
| | | $f_{IN} = 19.943MHz$ | | -70 | -63 | |
| | | $f_{IN} = 39.9MHz$ (Note 1) | | -69 | | |
| Small-Signal Bandwidth | | Input at -20dBFS, differential inputs | | 500 | | MHz |
| Full-Power Bandwidth | FPBW | Input at -0.5dBFS, differential inputs | | 400 | | MHz |
| Aperture Delay | t_{AD} | | | 1 | | ns |
| Aperture Jitter | t_{AJ} | | | 2 | | psrms |
| Overdrive Recovery Time | | For $1.5 \times$ full-scale input | | 2 | | ns |
| Differential Gain | | | | ± 1 | | % |
| Differential Phase | | | | ± 0.25 | | $^\circ$ |
| Output Noise | | $IN+ = IN- = COM$ | | 0.2 | | LSBrms |
| INTERNAL REFERENCE | | | | | | |
| Reference Output Voltage | REFOUT | | | 2.048 $\pm 1\%$ | | V |
| Reference Temperature Coefficient | TC_{REF} | | | 60 | | ppm/ $^\circ C$ |
| Load Regulation | | | | 1.25 | | mV/mA |
| BUFFERED EXTERNAL REFERENCE ($V_{REFIN} = 2.048V$) | | | | | | |
| REFIN Input Voltage | V_{REFIN} | | | 2.048 | | |
| Positive Reference Output Voltage | V_{REFP} | | | 2.012 | | V |
| Negative Reference Output Voltage | V_{REFN} | | | 0.988 | | V |
| Common-Mode Level | V_{COM} | | | $V_{DD}/2$ | | V |
| Differential Reference Output Voltage Range | ΔV_{REF} | $\Delta V_{REF} = V_{REFP} - V_{REFN}$, $T_A \geq +25^\circ C$ | 0.98 | 1.024 | 1.07 | V |
| REFIN Resistance | R_{REFIN} | | | > 50 | | $M\Omega$ |
| Maximum REFP, COM Source Current | I_{SOURCE} | | | 5 | | mA |
| Maximum REFP, COM Sink Current | I_{SINK} | | | -250 | | μA |

10-Bit, 60Msps, 3.0V, Low-Power ADC with Internal Reference

ELECTRICAL CHARACTERISTICS (continued)

($V_{DD} = 3.0V$, $OV_{DD} = 2.7V$; 0.1 μ F and 1.0 μ F capacitors from REFP, REFN, and COM to GND; $V_{REFIN} = 2.048V$, REFOUT connected to REFIN through a 10k Ω resistor, $V_{IN} = 2V_{P-P}$ (differential with respect to COM), $C_L \approx 10pF$ at digital outputs, $f_{CLK} = 62.5MHz$ (50% duty cycle), $T_A = T_{MIN}$ to T_{MAX} , unless otherwise noted. $\geq +25^\circ C$ guaranteed by production test, $< +25^\circ C$ guaranteed by design and characterization. Typical values are at $T_A = +25^\circ C$.)

| PARAMETER | SYMBOL | CONDITIONS | MIN | TYP | MAX | UNITS |
|---|------------------|--|-----|------------------------------|--------------------|------------|
| Maximum REFN Source Current | ISOURCE | | | 250 | | μA |
| Maximum REFN Sink Current | ISINK | | | -5 | | mA |
| UNBUFFERED EXTERNAL REFERENCE ($V_{REFIN} = AGND$, reference voltage applied to REFP, REFN, and COM) | | | | | | |
| REFP, REFN Input Resistance | RREFP, RREFN | Measured between REFP and COM and REFN and COM | | 4 | | K Ω |
| REFP, REFN, COM Input Capacitance | CIN | | | 15 | | pF |
| Differential Reference Input Voltage Range | ΔV_{REF} | $\Delta V_{REF} = V_{REFP} - V_{REFN}$ | | 1.024 $\pm 10\%$ | | V |
| COM Input Voltage Range | VCOM | | | $V_{DD}/2$ $\pm 10\%$ | | V |
| REFP Input Voltage | VREFP | | | $V_{COM} + \Delta V_{REF}/2$ | | V |
| REFN Input Voltage | VREFN | | | $V_{COM} - \Delta V_{REF}/2$ | | V |
| DIGITAL OUTPUTS (CLK, PD, \overline{OE}) | | | | | | |
| Input High Threshold | V_{IH} | CLK | | 0.8 x V_{DD} | | V |
| | | PD, \overline{OE} | | 0.8 x OV_{DD} | | |
| Input Low Threshold | V_{IL} | CLK | | | 0.2 x V_{DD} | V |
| | | PD, \overline{OE} | | | 0.2 x OV_{DD} | |
| Input Hysteresis | VHYST | | | 0.1 | | V |
| Input Leakage | I_{IH} | $V_{IH} = V_{DD} = OV_{DD}$ | | | ± 5 | μA |
| | I_{IL} | $V_{IL} = 0$ | | | ± 5 | |
| Input Capacitance | CIN | | | 5 | | pF |
| DIGITAL OUTPUTS (D9–D0) | | | | | | |
| Output Voltage Low | V_{OL} | $I_{SINK} = 200\mu A$ | | | 0.2 | V |
| Output Voltage High | V_{OH} | $I_{SOURCE} = 200\mu A$ | | | $OV_{DD} - 0.2$ | V |
| Three-State Leakage Current | I_{LEAK} | $\overline{OE} = OV_{DD}$ | | | ± 10 | μA |
| Three-State Output Capacitance | COUT | $\overline{OE} = OV_{DD}$ | | | 5 | pF |

10-Bit, 60Mps, 3.0V, Low-Power ADC with Internal Reference

MAX1446

ELECTRICAL CHARACTERISTICS (continued)

($V_{DD} = 3.0V$, $OV_{DD} = 2.7V$; 0.1 μF and 1.0 μF capacitors from REFP, REFN, and COM to GND; $V_{REFIN} = 2.048V$, REFOUT connected to REFIN through a 10k Ω resistor, $V_{IN} = 2V_{P-P}$ (differential with respect to COM), $C_L \approx 10pF$ at digital outputs, $f_{CLK} = 62.5MHz$ (50% duty cycle), $T_A = T_{MIN}$ to T_{MAX} , unless otherwise noted. $\geq +25^\circ C$ guaranteed by production test, $< +25^\circ C$ guaranteed by design and characterization. Typical values are at $T_A = +25^\circ C$.)

| PARAMETER | SYMBOL | CONDITIONS | MIN | TYP | MAX | UNITS |
|--|---------------|--|-----|-----------|-----|---------|
| POWER REQUIREMENTS | | | | | | |
| Analog Supply Voltage | V_{DD} | | 2.7 | 3.0 | 3.6 | V |
| Output Supply Voltage | OV_{DD} | $C_L = 10pF$ | 1.7 | 3.0 | 3.6 | V |
| Analog Supply Current | I_{VDD} | Operating, $f_{IN} = 19.943MHz$ at -0.5dBFS | | 30 | 37 | mA |
| | | Shutdown, clock idle, $PD = \overline{OE} = OV_{DD}$ | | 4 | 15 | μA |
| Output Supply Current | I_{OVDD} | Operating, $C_L = 15pF$, $f_{IN} = 19.943MHz$ at -0.5dBFS | | 7 | | mA |
| | | Shutdown, clock idle, $PD = \overline{OE} = OV_{DD}$ | | 1 | 20 | μA |
| Power-Supply Rejection | PSRR | Offset | | ± 0.1 | | mV/V |
| | | Gain | | ± 0.1 | | %/V |
| TIMING CHARACTERISTICS | | | | | | |
| CLK Rise to Output Data Valid | t_{DO} | Figure 5 (Notes 3, 6) | 2 | 5 | 8 | ns |
| \overline{OE} Fall to Output Enable | t_{ENABLE} | Figure 5 | | 10 | | ns |
| \overline{OE} Rise to Output Disable | $t_{DISABLE}$ | Figure 5 | | 1.5 | | ns |
| Clock Duty Cycle | | Figure 6, clock period 16ns (Notes 5, 6) | 45 | | 55 | % |
| Wake-Up Time | t_{WAKE} | (Notes 4, 6) | | 366 | 520 | μs |

Note 1: SNR, SINAD, THD, SFDR, and HD3 are based on an analog input voltage of -0.5dBFS referenced to a 1.024V full-scale input voltage range.

Note 2: Intermodulation distortion is the total power of the intermodulation products relative to the individual carrier. This number is 6dB better, if referenced to the two-tone envelope.

Note 3: Digital outputs settle to V_{IH} , V_{IL} .

Note 4: Wake-up time is defined as the time from complete reference power-down until the ADC performs within 0.3 ENOB of the final performance for $f_{IN} = 10MHz$ at -0.5dBFS input amplitude. $V_{REFIN} = 2.048V$, REFP, REFN, and CML decoupled with 2.3 μF .

Note 5: Dynamic characteristics guaranteed at $f_{IN} = 19.943MHz$ for the specified duty-cycle range.

Note 6: Guaranteed by design and engineering characterization.

10-Bit, 60Mps, 3.0V, Low-Power ADC with Internal Reference

Typical Operating Characteristics

($V_{DD} = 3.0V$, $OV_{DD} = 2.7V$, internal reference, differential input at $-0.5dBFS$, $f_{CLK} = 62.35MHz$, $C_L \approx 10pF$, $T_A = +25^\circ C$, unless otherwise noted.)

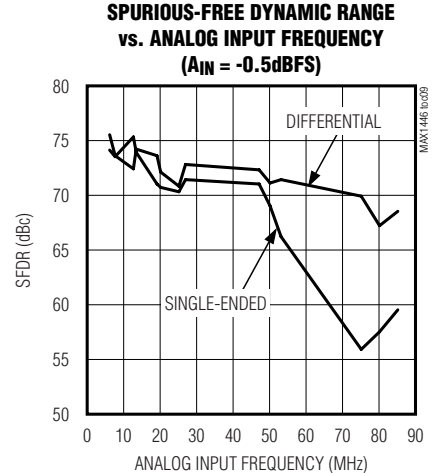
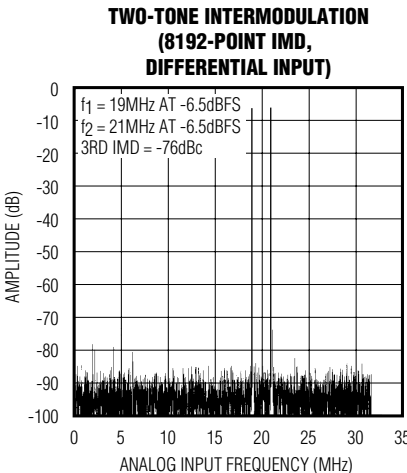
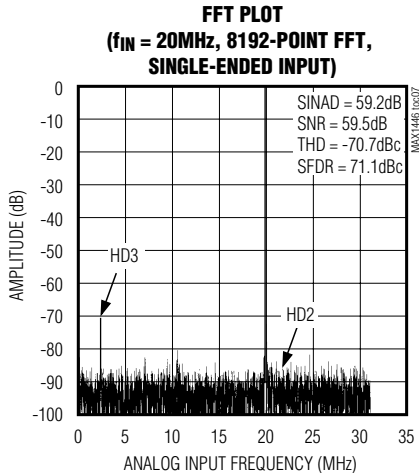
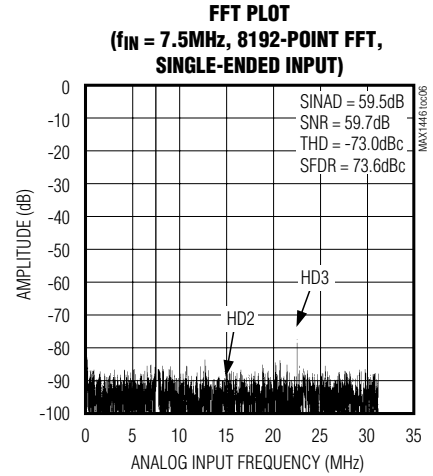
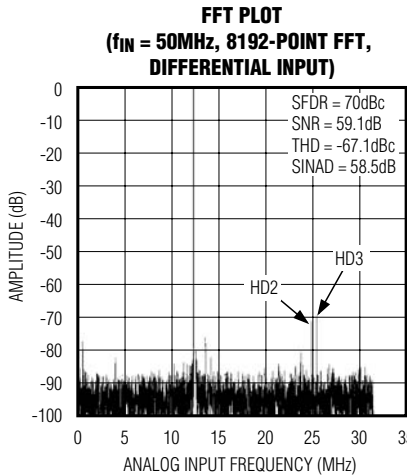
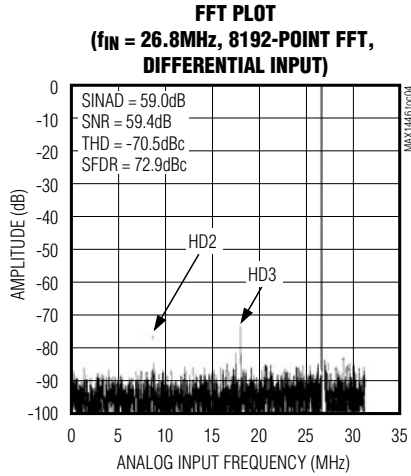
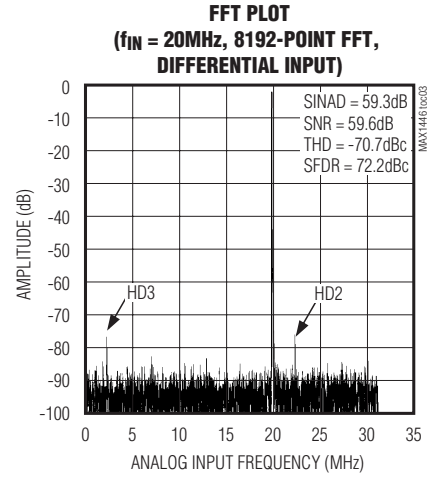
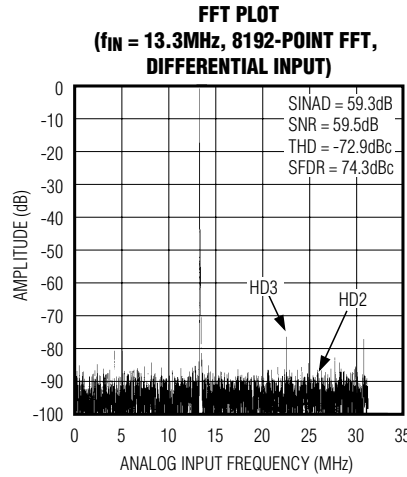
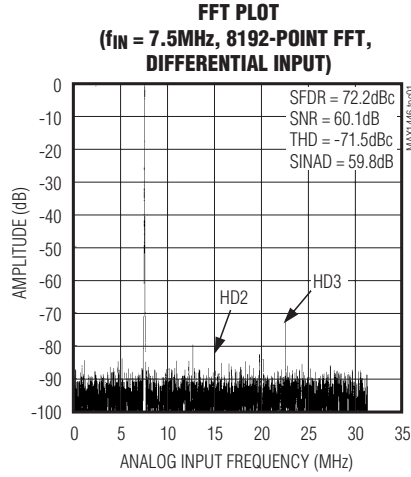

10-Bit, 60Mps, 3.0V, Low-Power ADC with Internal Reference

MAX1446

Typical Operating Characteristics (continued)

($V_{DD} = 3.0V$, $OV_{DD} = 2.7V$, internal reference, differential input at $-0.5dBFS$, $f_{CLK} = 62.35MHz$, $C_L \approx 10pF$, $T_A = +25^\circ C$, unless otherwise noted.)

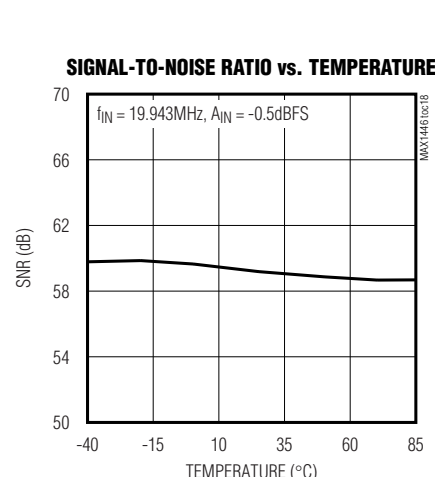
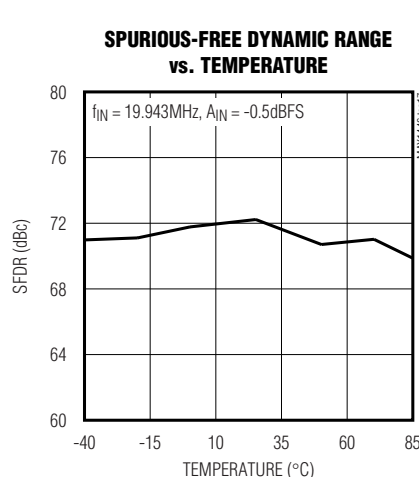
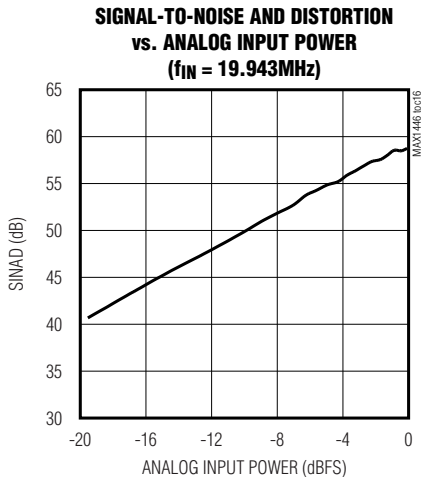
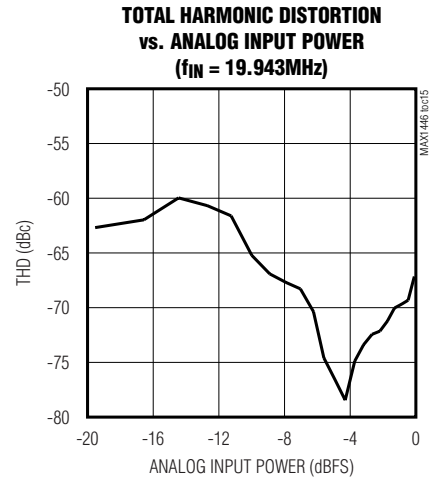
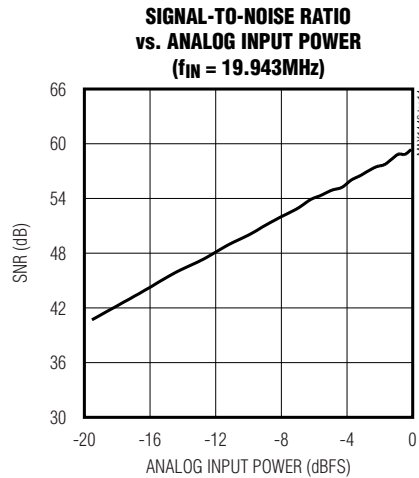
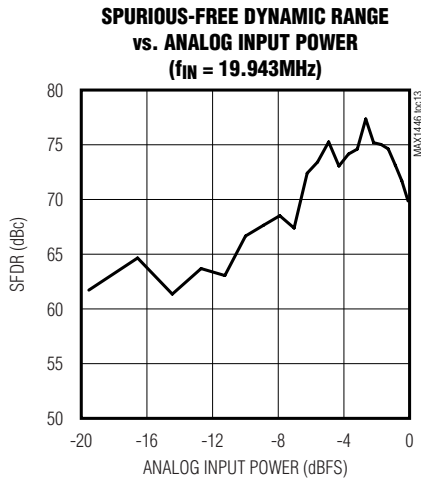
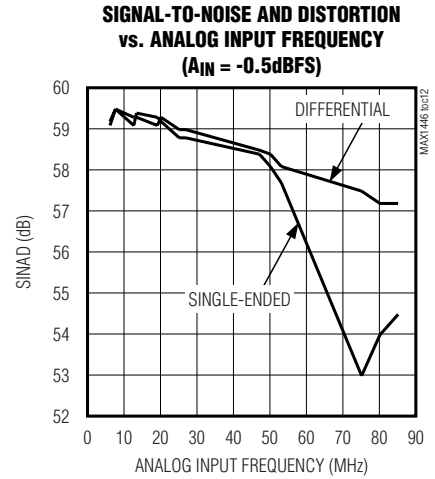
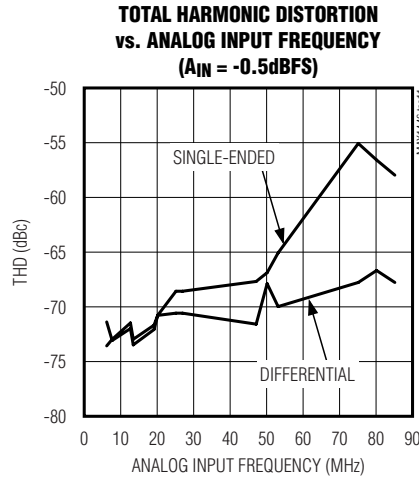
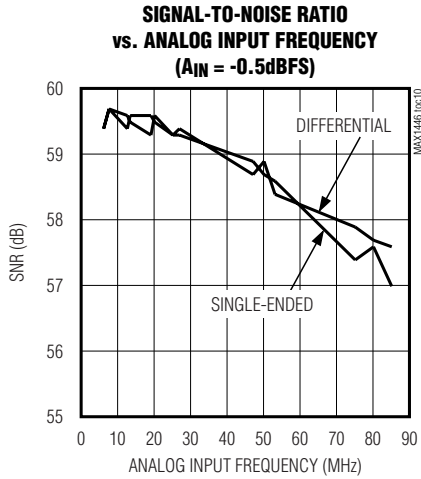

10-Bit, 60Mps, 3.0V, Low-Power ADC with Internal Reference

Typical Operating Characteristics (continued)

($V_{DD} = 3.0V$, $OV_{DD} = 2.7V$, internal reference, differential input at $-0.5dBFS$, $f_{CLK} = 62.35MHz$, $C_L \approx 10pF$, $T_A = +25^\circ C$, unless otherwise noted.)

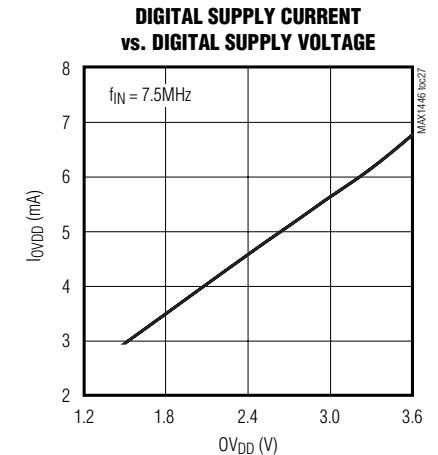
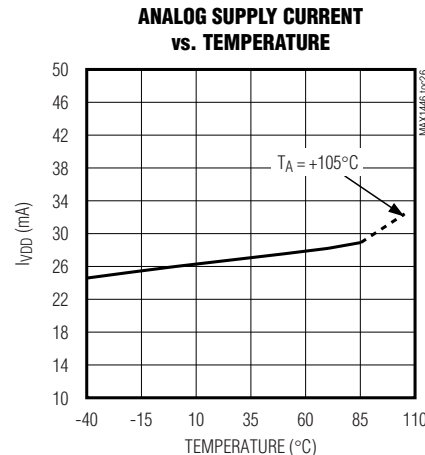
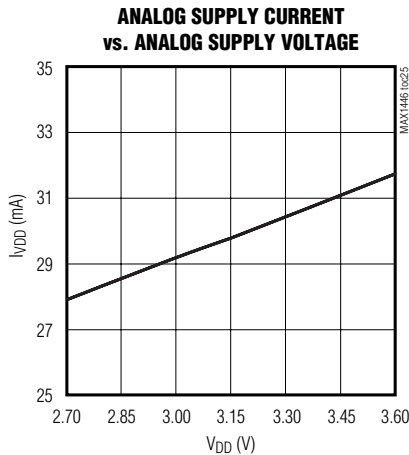
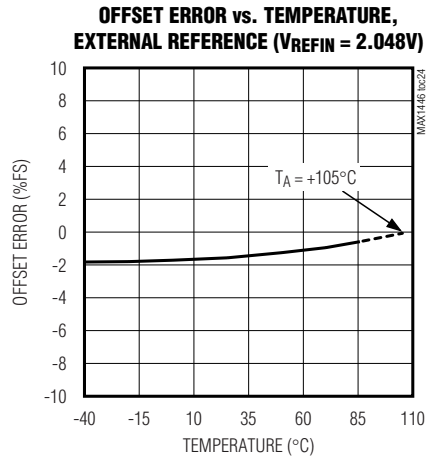
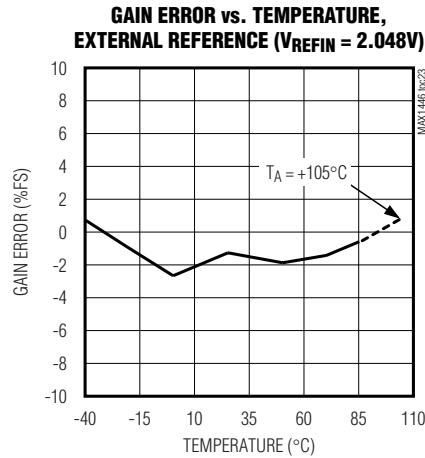
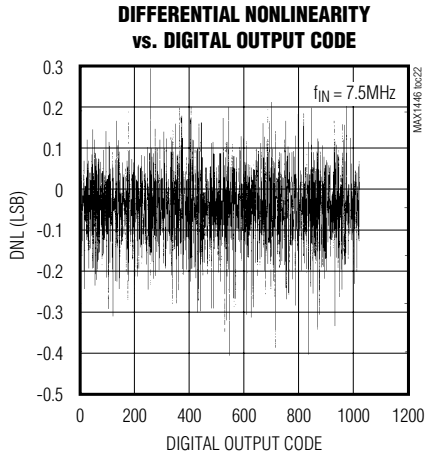
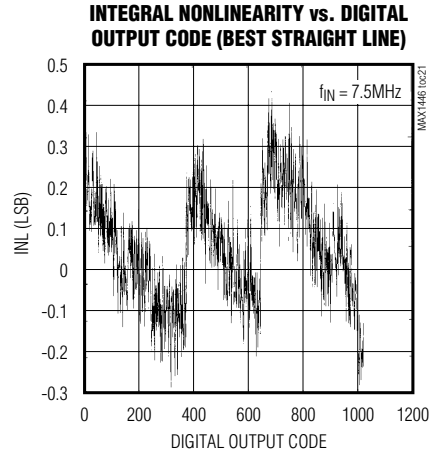
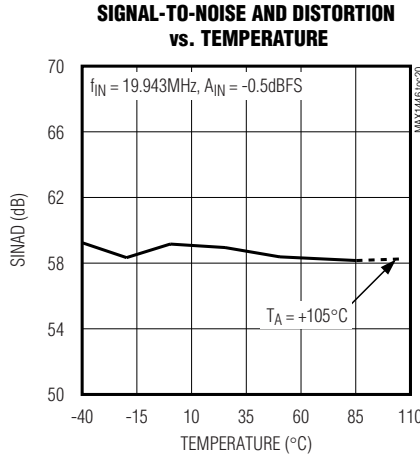
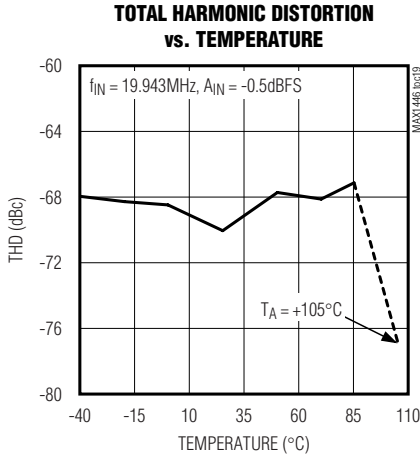

10-Bit, 60Mps, 3.0V, Low-Power ADC with Internal Reference

MAX1446

Typical Operating Characteristics (continued)

($V_{DD} = 3.0V$, $OV_{DD} = 2.7V$, internal reference, differential input at $-0.5dBFS$, $f_{CLK} = 62.35MHz$, $C_L \approx 10pF$, $T_A = +25^\circ C$, unless otherwise noted.)

DIGITAL SUPPLY CURRENT vs. TEMPERATURE

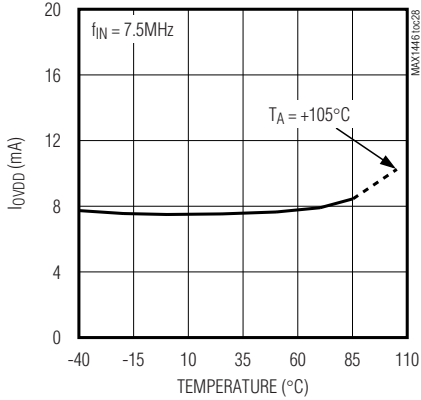

ANALOG POWER-DOWN CURRENT vs. ANALOG POWER SUPPLY

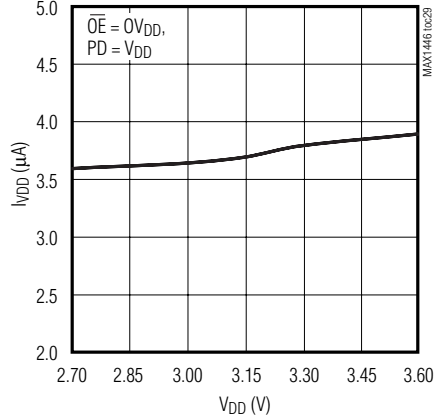

DIGITAL POWER-DOWN CURRENT vs. DIGITAL POWER SUPPLY

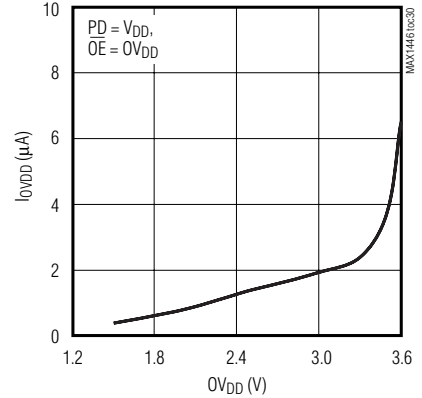

SNR/SINAD, -THD/SFDR vs. CLOCK FREQUENCY

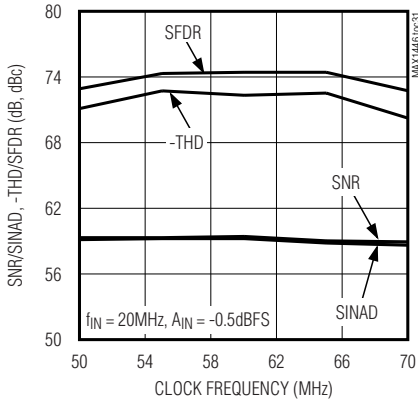

INTERNAL REFERENCE VOLTAGE vs. ANALOG SUPPLY VOLTAGE

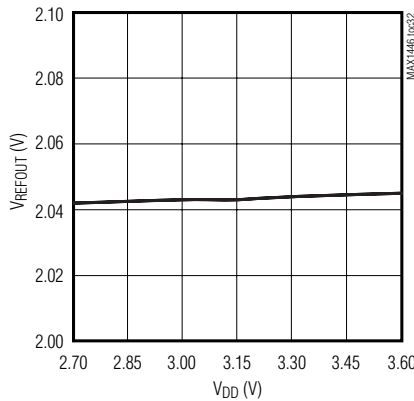

INTERNAL REFERENCE VOLTAGE vs. TEMPERATURE

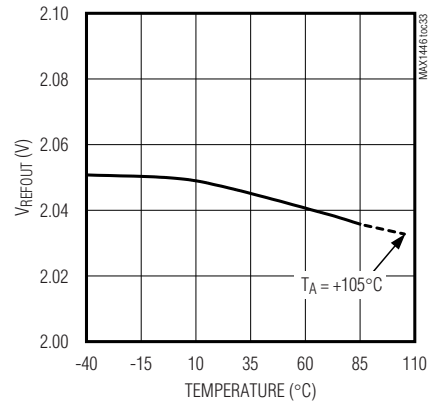

OUTPUT NOISE HISTOGRAM (DC INPUT)

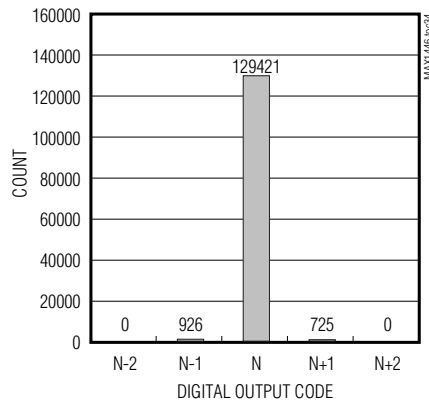

10-Bit, 60Msps, 3.0V, Low-Power ADC with Internal Reference

Pin Description

| PIN | NAME | FUNCTION |
|---------------------|------------------------|--|
| 1 | REFN | Lower Reference. Conversion range is $\pm(V_{REFP} - V_{REFN})$. Bypass to GND with a $> 0.1\mu\text{F}$ capacitor. |
| 2 | COM | Common-Mode Voltage Output. Bypass to GND with a $> 0.1\mu\text{F}$ capacitor. |
| 3, 9, 10 | VDD | Analog Supply Voltage. Bypass to GND with a capacitor combination of $2.2\mu\text{F}$ in parallel with $0.1\mu\text{F}$. |
| 4, 5, 8, 11, 14, 30 | GND | Analog Ground |
| 6 | IN+ | Positive Analog Input. For single-ended operation, connect signal source to IN+. |
| 7 | IN- | Negative Analog Input. For single-ended operation, connect IN- to COM. |
| 12 | CLK | Conversion Clock Input |
| 13 | PD | Power-Down Input High: power-down mode Low: normal operation |
| 15 | $\overline{\text{OE}}$ | Output Enable Input High: digital outputs disabled Low: digital outputs enabled |
| 16–20 | D9–D5 | Three-State Digital Outputs D9–D5. D9 is the MSB. |
| 21 | OVDD | Output Driver Supply Voltage. Bypass to GND with a capacitor combination of $2.2\mu\text{F}$ in parallel with $0.1\mu\text{F}$. |
| 22 | T.P. | Test Point. Do not connect. |
| 23 | OGND | Output Driver Ground |
| 24–28 | D4–D0 | Three-State Digital Outputs D4–D0. D0 is the LSB. |
| 29 | REFOUT | Internal Reference Voltage Output. May be connected to REFIN through a resistor or a resistor-divider. |
| 31 | REFIN | Reference Input. $V_{REFIN} = 2 \times (V_{REFP} - V_{REFN})$. Bypass to GND with a $> 0.01\mu\text{F}$ capacitor. |
| 32 | REFP | Upper Reference. Conversion range is $\pm(V_{REFP} - V_{REFN})$. Bypass to GND with a $> 0.1\mu\text{F}$ capacitor. |

10-Bit, 60Mps, 3.0V, Low-Power ADC with Internal Reference

Detailed Description

The MAX1446 uses a 10-stage, fully differential, pipelined architecture (Figure 1) that allows for high-speed conversion while minimizing power consumption. Each sample moves through a pipeline stage every half-clock cycle. Counting the delay through the output latch, the clock-cycle latency is 5.5.

A 1.5-bit (2-comparator) flash ADC converts the held input voltage into a digital code. The following digital-to-analog converter (DAC) converts the digitized result back into an analog voltage, which is then subtracted from the original held input signal. The resulting error signal is then multiplied by two, and the product is passed along to the next pipeline stage where the process is repeated until the signal has been processed by all 10 stages. Each stage provides a 1-bit resolution. Digital error correction compensates for ADC comparator offsets in each pipeline stage and ensures no missing codes.

Input Track-and-Hold Circuit

Figure 2 displays a simplified functional diagram of the input T/H circuit in both track and hold mode. In track mode, switches S1, S2a, S2b, S4a, S4b, S5a, and S5b are closed. The fully differential circuit samples the input signal onto the two capacitors (C2a and C2b). S2a and S2b set the common mode for the amplifier

input. The resulting differential voltage is held on C2a and C2b. S4a, S4b, S5a, S5b, S1, S2a, and S2b are then opened before S3a, S3b and S4c are closed, connecting capacitors C1a and C1b to the amplifier output, and S4c is closed. This charges C1a and C1b to the same values originally held on C2a and C2b. This value is then presented to the first stage quantizer and isolates the pipeline from the fast-changing input. The wide-input-bandwidth T/H amplifier allows the MAX1446 to track and sample/hold analog inputs of high frequencies beyond Nyquist. The analog inputs (IN+ and IN-) can be driven either differentially or single ended. It is recommended to match the impedance of IN+ and IN- and set the common-mode voltage to mid-supply ($V_{DD}/2$) for optimum performance.

Analog Input and Reference Configuration

The MAX1446 full-scale range is determined by the internally generated voltage difference between REFP ($V_{DD}/2 + V_{REFIN}/4$) and REFN ($V_{DD}/2 - V_{REFIN}/4$). The ADC's full-scale range is user adjustable through the REFIN pin, which provides a high input impedance for this purpose. REFOUT, REFP, COM ($V_{DD}/2$), and REFN are internally buffered, low-impedance outputs.

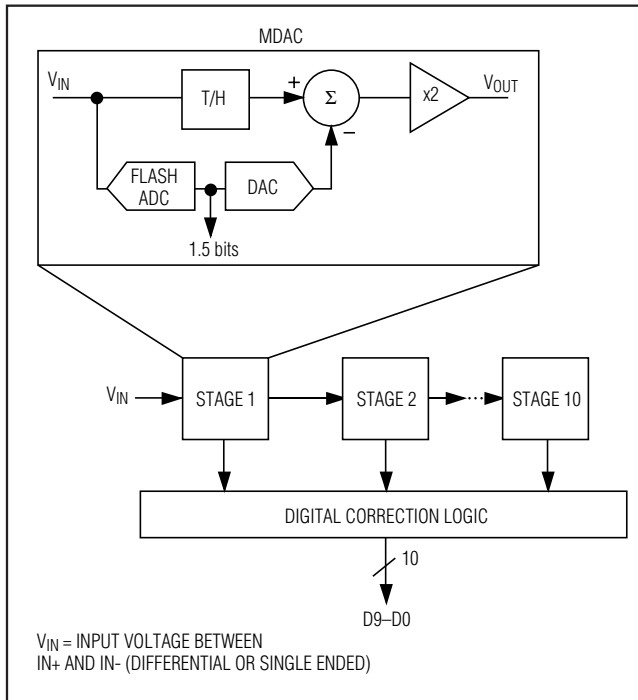

Figure 1. Pipelined Architecture—Stage Blocks

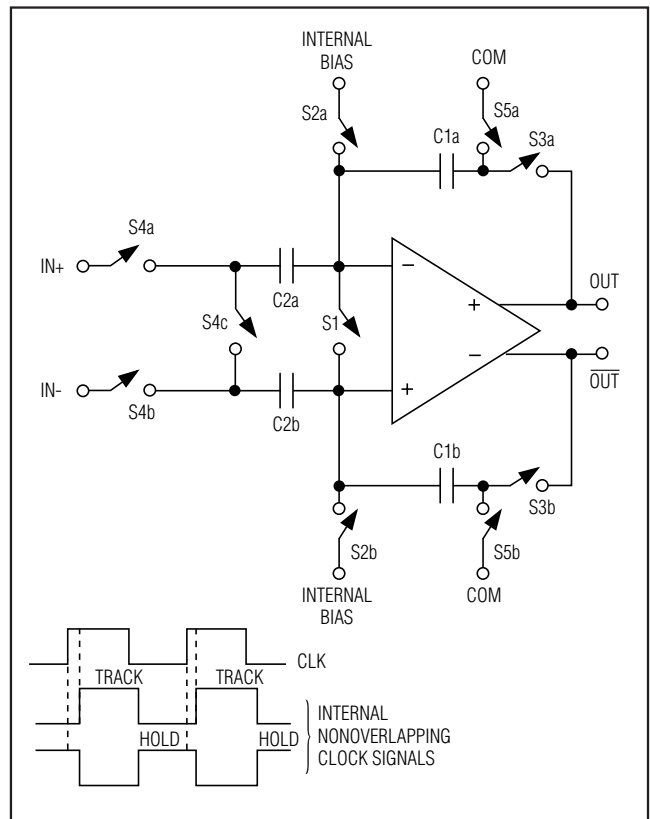

Figure 2. Internal T/H Circuit

10-Bit, 60Msps, 3.0V, Low-Power ADC with Internal Reference

The MAX1446 provides three modes of reference operation:

- Internal reference mode
- Buffered external reference mode
- Unbuffered external reference mode

In internal reference mode, the internal reference output (REFOUT) can be tied to the REFIN pin through a resistor (e.g., 10k Ω) or resistor-divider if an application requires a reduced full-scale range. For stability purposes, it is recommended to bypass REFIN with a > 10nF capacitor to GND.

In buffered external reference mode, the reference voltage levels can be adjusted externally by applying a stable and accurate voltage at REFIN. In this mode, REFOUT may be left open or connected to REFIN through a > 10k Ω resistor.

In unbuffered external reference mode, REFIN is connected to GND, thereby deactivating the on-chip buffers of REFP, COM, and REFN. With their buffers shut down, these pins become high impedance and can be driven by external reference sources.

Clock Input (CLK)

The MAX1446 CLK input accepts CMOS-compatible clock signals. Since the interstage conversion of the device depends on the repeatability of the rising and falling edges of the external clock, use a clock with low jitter and fast rise and fall times (< 2ns). In particular, sampling occurs on the falling edge of the clock signal, mandating this edge to provide lowest possible jitter. Any significant aperture jitter would limit the SNR performance of the ADC as follows:

$$\text{SNR} = 20 \times \log \left(\frac{1}{2 \times \pi \times f_{\text{IN}} \times t_{\text{AJ}}} \right)$$

where f_{IN} represents the analog input frequency, and t_{AJ} is the time of the aperture jitter.

Clock jitter is especially critical for undersampling applications. The clock input should always be considered as an analog input and routed away from any analog input or other digital signal lines.

The MAX1446 clock input operates with a voltage threshold set to $V_{\text{DD}}/2$. Clock inputs with a duty cycle other than 50% must meet the specifications for high and low periods as stated in the *Electrical Characteristics*. See Figures 3a, 3b, 4a, and 4b for the relationship between spurious-free dynamic range (SFDR), signal-to-noise ratio (SNR), total harmonic distortion (THD), or signal-to-noise plus distortion (SINAD) vs. duty cycle.

Output Enable ($\overline{\text{OE}}$), Power-Down (PD), and Output Data (D0–D9)

All data outputs, D0 (LSB) through D9 (MSB), are TTL/CMOS-logic compatible. There is a 5.5 clock-cycle latency between any particular sample and its valid output data. The output coding is straight offset binary (Table 1). With $\overline{\text{OE}}$ and PD (power-down) high, the digital output enters a high-impedance state. If $\overline{\text{OE}}$ is held low with PD high, the outputs are latched at the last value prior to the power-down.

The capacitive load on the digital outputs D0–D9 should be kept as low as possible (< 15pF) to avoid large digital currents that could feed back into the analog portion of the MAX1446, degrading its dynamic performance. The use of buffers on the ADC's digital outputs can further isolate the digital outputs from heavy capacitive loads.

To further improve the dynamic performance of the MAX1446 small series resistors (e.g., 100 Ω) may be added to the digital output paths, close to the ADC.

Figure 5 displays the timing relationship between output enable and data output valid, as well as power-down/wake-up and data output valid.

System Timing Requirements

Figure 6 shows the relationship between the clock input, analog input, and data output. The MAX1446

Table 1. MAX1446 Output Code for Differential Inputs

| DIFFERENTIAL INPUT VOLTAGE* | DIFFERENTIAL INPUT | STRAIGHT OFFSET BINARY |
|----------------------------------|----------------------------|------------------------|
| $V_{\text{REF}} \times 511/512$ | +Full Scale -1LSB | 11 1111 1111 |
| $V_{\text{REF}} \times 510/512$ | +Full Scale -2LSB | 11 1111 1110 |
| $V_{\text{REF}} \times 1/512$ | +1LSB | 10 0000 0001 |
| 0 | Bipolar Zero | 10 0000 0000 |
| $-V_{\text{REF}} \times 1/512$ | -1LSB | 01 1111 1111 |
| $-V_{\text{REF}} \times 511/512$ | Negative Full Scale + 1LSB | 00 0000 0001 |
| $-V_{\text{REF}} \times 512/512$ | Negative Full Scale | 00 0000 0000 |

* $V_{\text{REFIN}} = V_{\text{REFP}} = V_{\text{REFN}}$

10-Bit, 60Mps, 3.0V, Low-Power ADC with Internal Reference

MAX1446

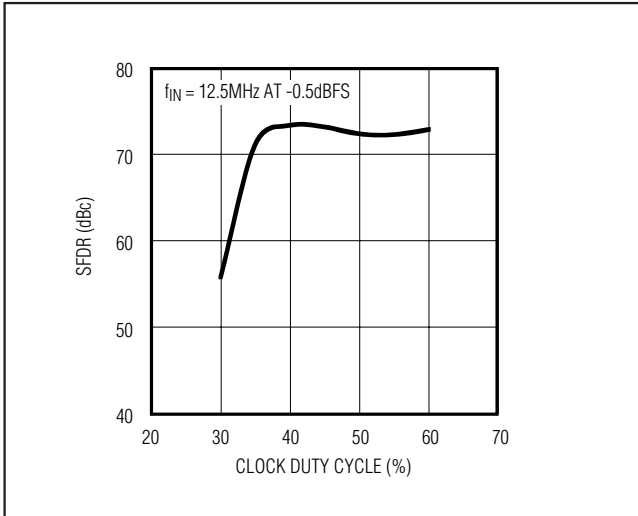

Figure 3a. SFDR vs. Clock Duty Cycle (Differential Input)

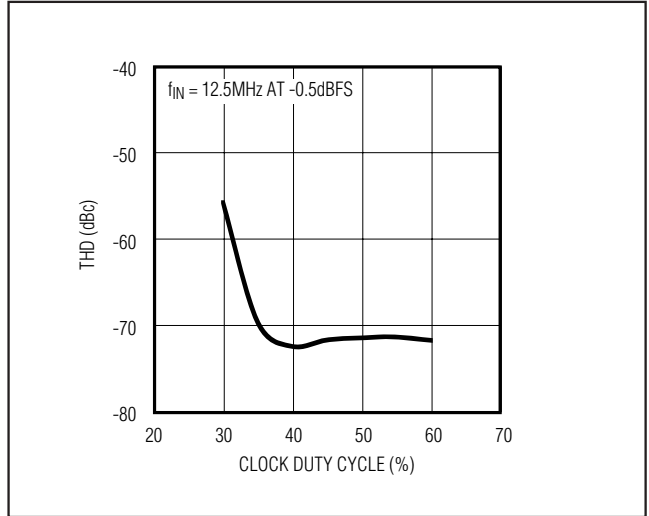

Figure 4a. THD vs. Clock Duty Cycle (Differential Input)

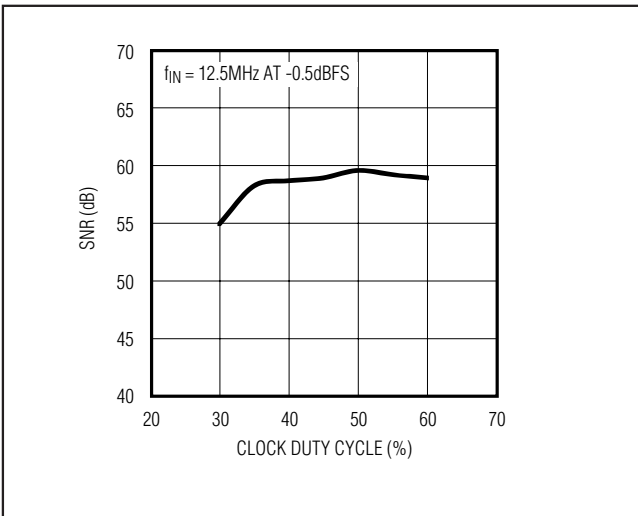

Figure 3b. SNR vs. Clock Duty Cycle (Differential Input)

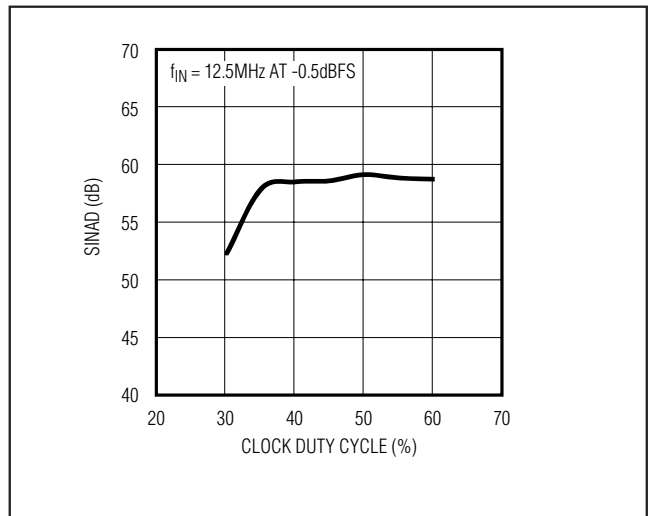

Figure 4b. SINAD vs. Clock Duty Cycle (Differential Input)

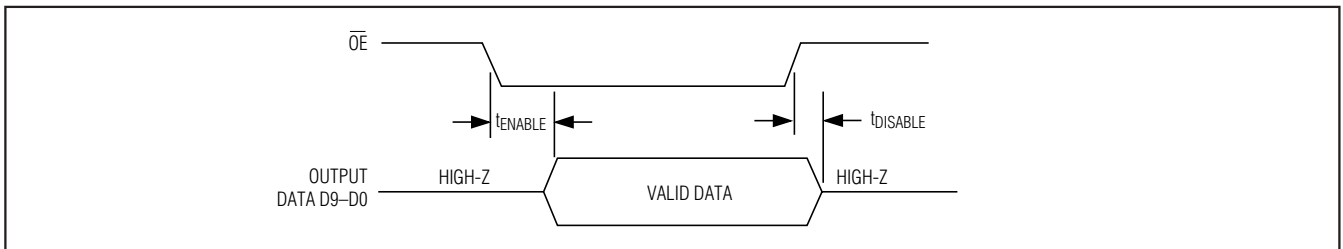

Figure 5. Output Enable Timing

10-Bit, 60MSPS, 3.0V, Low-Power ADC with Internal Reference

samples at the falling edge of the input clock. Output data is valid on the rising edge of the input clock. The output data has an internal latency of 5.5 clock cycles. Figure 6 also shows the relationship between the input clock parameters and the valid output data.

Applications Information

Figure 7 shows a typical application circuit containing a single-ended to differential converter. The internal reference provides a $V_{DD}/2$ output voltage for level shifting purposes. The input is buffered and then split to a voltage follower and inverter. A lowpass filter follows the op amps to suppress some of the wideband noise associated with high-speed op amps. The user may select the R_{ISO} and C_{IN} values to optimize the filter performance to suit a particular application. For the application in Figure 7, an R_{ISO} of 50Ω is placed before the capacitive load to prevent ringing and oscillation. The 22pF C_{IN} capacitor acts as a small bypassing capacitor.

Using Transformer Coupling

An RF transformer (Figure 8) provides an excellent solution for converting a single-ended source signal to a fully differential signal, required by the MAX1446 for optimum performance. Connecting the transformer's center tap to COM provides a $V_{DD}/2$ DC level shift to the input. Although a 1:1 transformer is shown, a step-up transformer may be selected to reduce the drive requirements. A reduced signal swing from the input

driver, such as an op amp, may also improve the overall distortion.

In general, the MAX1446 provides better SFDR and THD with fully differential input signals than single-ended drive, especially for very high input frequencies. In differential input mode, even-order harmonics are lower since both inputs ($IN+$, $IN-$) are balanced, and each of the inputs only requires half the signal swing compared to single-ended mode.

Single-Ended AC-Coupled Input Signal

Figure 9 shows an AC-coupled, single-ended application. The MAX4108 op amp provides high speed, high bandwidth, low noise, and low distortion to maintain the integrity of the input signal.

Buffered External Reference Drives Multiple ADCs

Multiple-converter systems based on the MAX1446 are well suited for use with a common reference voltage. The REFIN pin of those converters can be connected directly to an external reference source. A precision bandgap reference like the MAX6062 generates an external DC level of 2.048V (Figure 10), and exhibits a noise voltage density of $150nV/\sqrt{Hz}$. Its output passes through a 1-pole lowpass filter (with 10Hz cutoff frequency) to the MAX4250, which buffers the reference before its output is applied to a second 10Hz lowpass

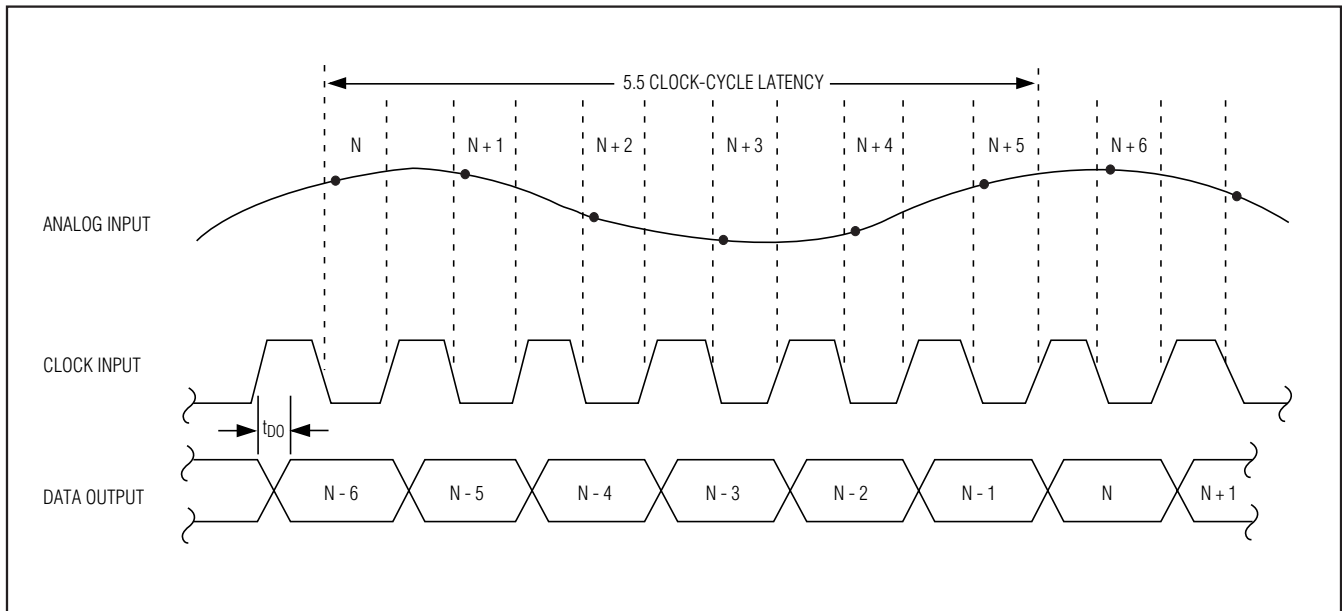

Figure 6. System and Output Timing Diagram

10-Bit, 60Mps, 3.0V, Low-Power ADC with Internal Reference

MAX1446

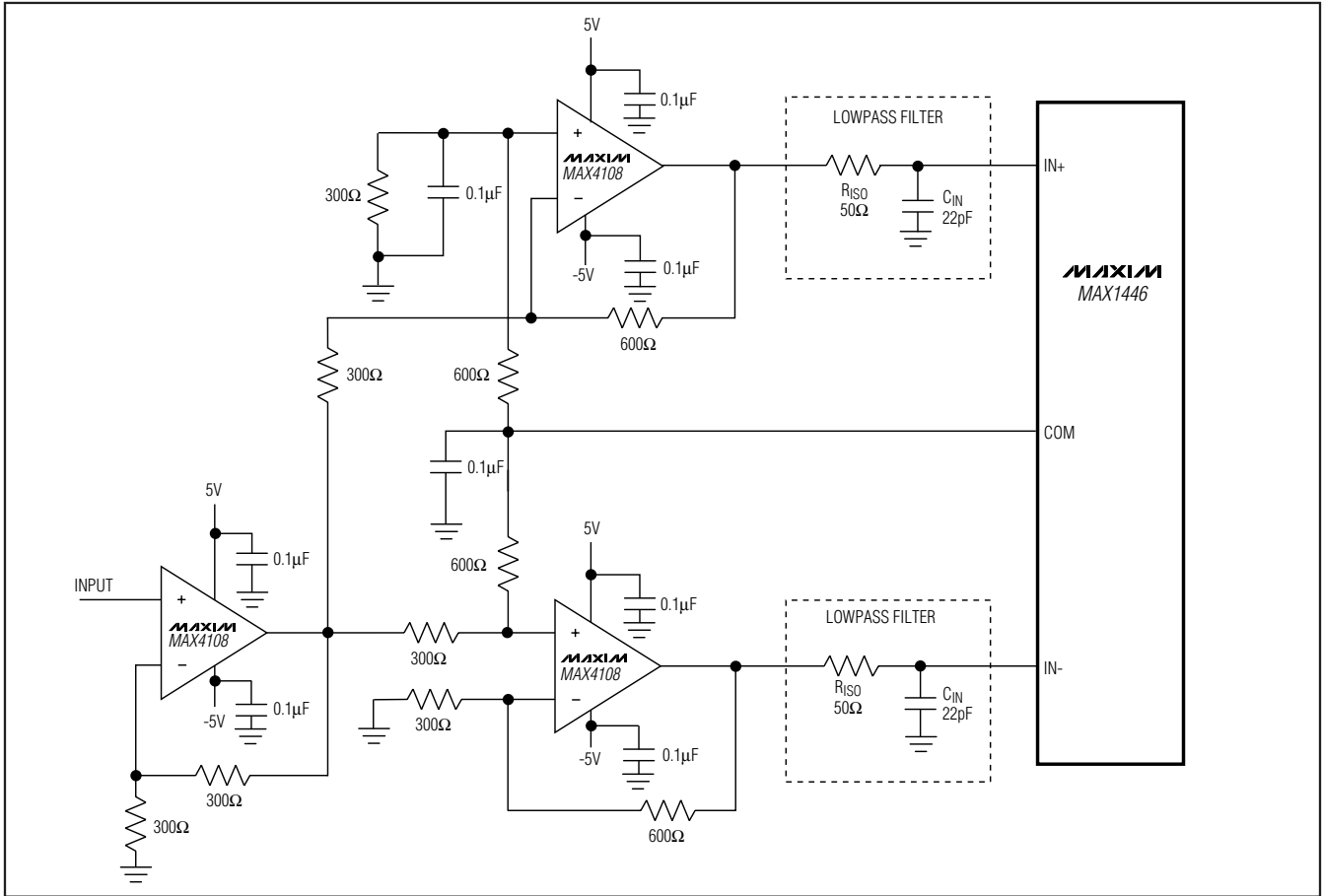

Figure 7. Typical Application Circuit for Single-Ended to Differential Conversion

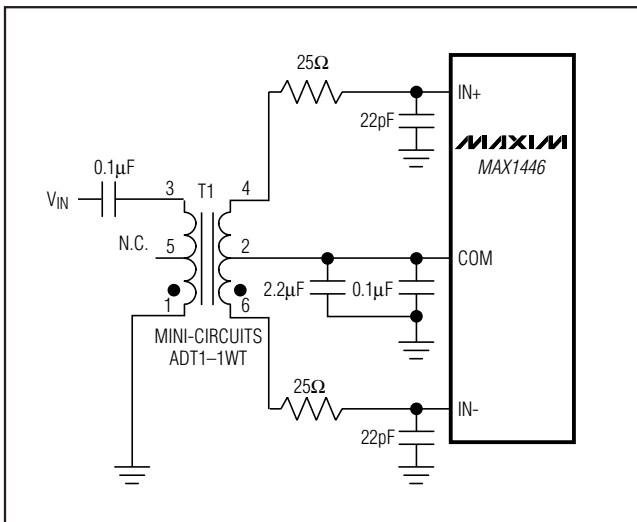

Figure 8. Using a Transformer for AC-Coupling

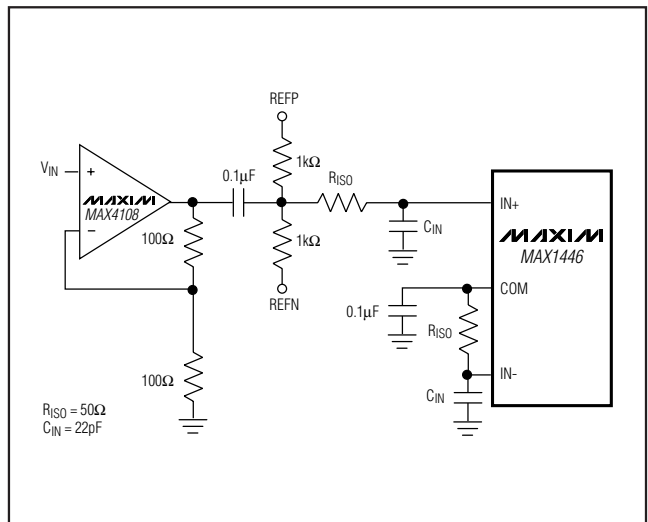

Figure 9. Single-Ended AC-Coupled Input

10-Bit, 60Msps, 3.0V, Low-Power ADC with Internal Reference

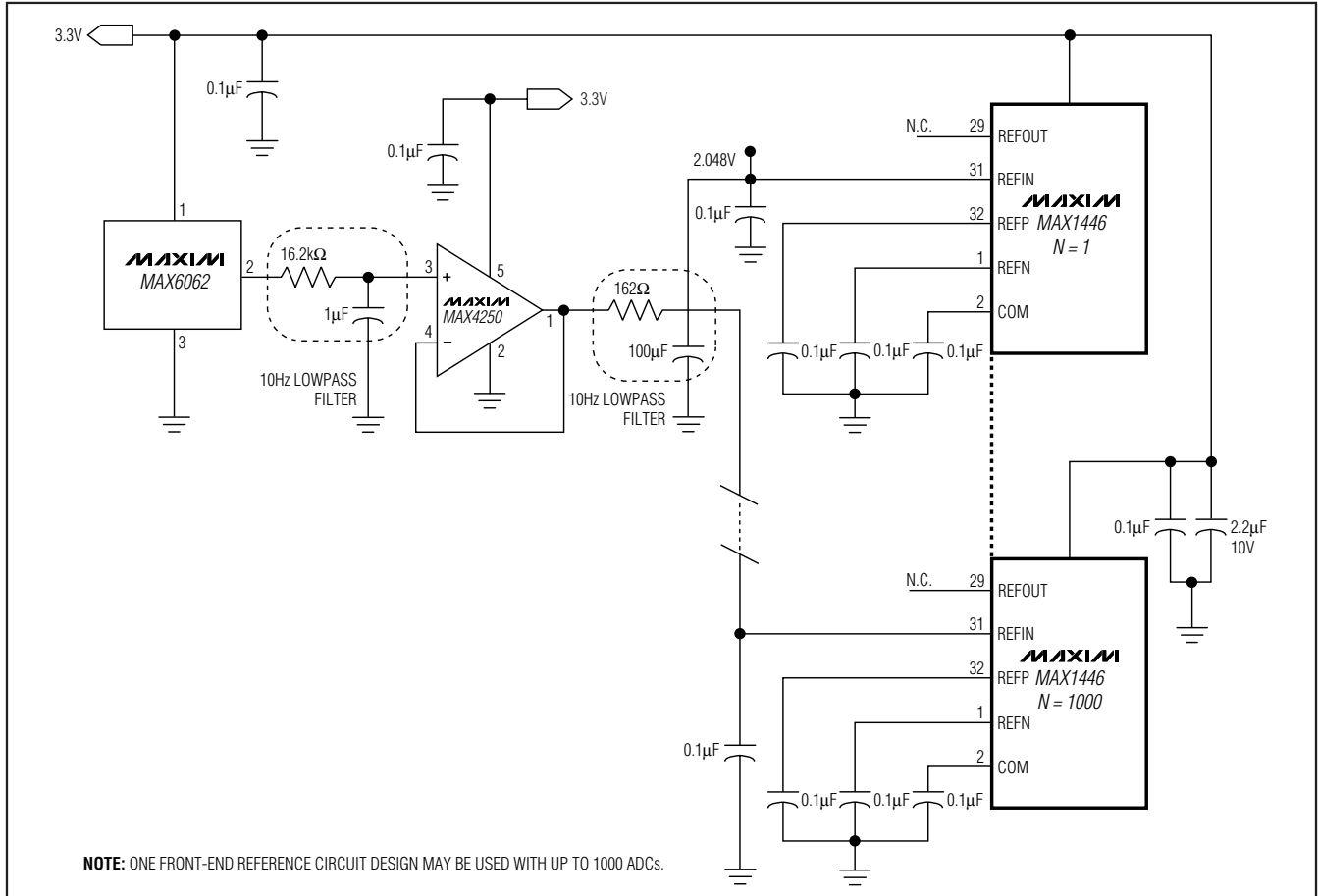

Figure 10. Buffered External Reference Drives Up to 1000 ADCs

filter. The MAX4250 provides a low offset voltage (for high-gain accuracy) and a low noise level. The passive 10Hz filter following the buffer attenuates noise produced in the voltage reference and buffer stages. This filtered noise density, which decreases for higher frequencies, meets the noise levels specified for precision ADC operation.

Unbuffered External Reference Drives Multiple ADCs

Connecting each REFIN to analog ground disables the internal reference of each device, allowing the internal reference ladders to be driven directly by a set of external reference sources. Followed by a 10Hz lowpass filter and precision voltage-divider (Figure 11), the MAX6066 generates a DC level of 2.500V. The buffered outputs of this divider are set to 2.0V, 1.5V, and 1.0V, with an accuracy that depends on the tolerance of the divider resistors. The three voltages are buffered by the

MAX4252, which provides low noise and low DC offset. The individual voltage followers are connected to 10Hz lowpass filters, which filter both the reference voltage and amplifier noise to a level of $3n\sqrt{\text{Hz}}$. The 2.0V and 1.0V reference voltages set the differential full-scale range of the associated ADCs at 2V_{p-p}. The 2.0V and 1.0V buffers drive the ADC's internal ladder resistances between them. Note that the common power supply for all active components removes any concern regarding power-supply sequencing when powering up or down. With the outputs of the MAX4252 matching better than 0.1%, the buffers and subsequent lowpass filters can be replicated to support as many as 32 ADCs. For applications that require more than 32 matched ADCs, a voltage reference and divider string common to all converters is highly recommended.

10-Bit, 60Msps, 3.0V, Low-Power ADC with Internal Reference

ground pins could share the same ground plane if the ground plane is sufficiently isolated from any noisy, digital systems ground plane (e.g., downstream output buffer or DSP ground plane). Route high-speed digital signal traces away from sensitive analog traces. Keep all signal lines short and free of 90° turns.

Static Parameter Definitions

Integral Nonlinearity

Integral nonlinearity (INL) is the deviation of the values on an actual transfer function from a straight line. This straight line can be either a best-straight-line fit or a line drawn between the endpoints of the transfer function once offset and gain errors have been nullified. The MAX1446's static linearity parameters are measured using the best-straight-line fit method.

Differential Nonlinearity

Differential nonlinearity (DNL) is the difference between an actual step width and the ideal value of 1LSB. A DNL error specification of less than 1LSB guarantees no missing codes and a monotonic transfer function.

Dynamic Parameter Definitions

Aperture Jitter

Figure 12 depicts the aperture jitter (t_{AJ}), which is the sample-to-sample variation in the aperture delay.

Aperture Delay

Aperture delay (t_{AD}) is the time defined between the falling edge of the sampling clock and the instant when an actual sample is taken (Figure 12).

Signal-to-Noise Ratio (SNR)

For a waveform perfectly reconstructed from digital samples, the theoretical maximum SNR is the ratio of the full-scale analog input (rms value) to the rms quantization error (residual error). The ideal, theoretical minimum A/D noise is caused by quantization error only and results directly from the ADC's resolution (N bits):

$$SNR_{(MAX)} = 6.02 \times N + 1.76$$

In reality, there are other noise sources besides quantization noise: thermal noise, reference noise, clock jitter, etc. SNR is computed by taking the ratio of the rms signal to the rms noise, which includes all spectral components minus the fundamental, the first five harmonics, and the DC offset.

Signal-to-Noise Plus Distortion (SINAD)

SINAD is computed by taking the ratio of the rms signal to all spectral components minus the fundamental and the DC offset.

Effective Number of Bits (ENOB)

ENOB specifies the dynamic performance of an ADC at a specific input frequency and sampling rate. An ideal ADC's error consists of quantization noise only. ENOB is computed from:

$$ENOB = \frac{(SINAD - 1.76)}{6.02}$$

Total Harmonic Distortion (THD)

THD is typically the ratio of the rms sum of the input signal's first four harmonics to the fundamental itself. This is expressed as:

$$THD = 20 \times \log \left(\frac{\sqrt{V_2^2 + V_3^2 + V_4^2 + V_5^2}}{V_1} \right)$$

where V_1 is the fundamental amplitude, and V_2 through V_5 are the amplitudes of the 2nd- through 5th-order harmonics.

Spurious-Free Dynamic Range (SFDR)

SFDR is the ratio expressed in decibels of the rms amplitude of the fundamental (maximum signal component) to the rms value of the next largest spurious component, excluding DC offset.

Intermodulation Distortion (IMD)

The two-tone IMD is the ratio expressed in decibels of either input tone to the worst 3rd-order (or higher) intermodulation products. The individual input tone levels are at -6.5dB full scale.

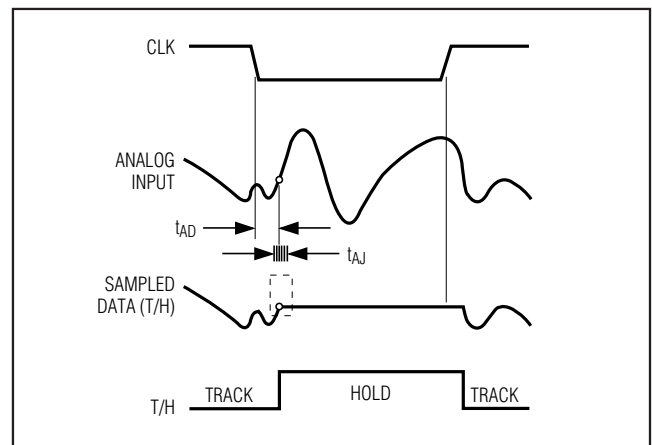
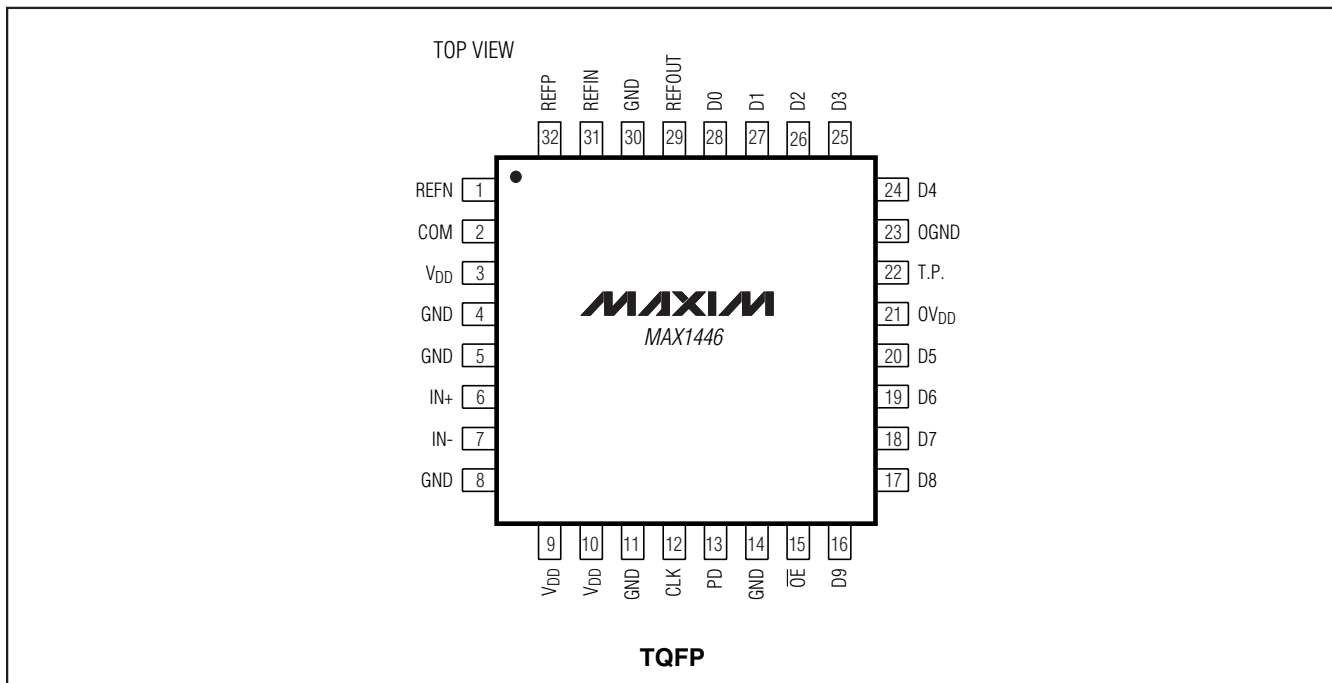

Figure 12. T/H Aperture Timing

10-Bit, 60Mps, 3.0V, Low-Power ADC with Internal Reference

Pin Configurations (continued)

MAX1446



Package Information

For the latest package outline information and land patterns, go to www.maxim-ic.com/packages.

| PACKAGE TYPE | PACKAGE CODE | DOCUMENT NO. |
|--------------|--------------|-------------------------|
| 32 TQFP | H32-2F | 21-0110 |

10-Bit, 60Msps, 3.0V, Low-Power ADC with Internal Reference

Revision History

| REVISION NUMBER | REVISION DATE | DESCRIPTION | PAGES CHANGED |
|-----------------|---------------|---|---------------------|
| 3 | 11/07 | Various corrections; updated to extended temperature range for automotive applications; replaced TOCs 9–20, 23, 24, 26, 30, 31, 33; updated package outlines. | 1–9, 15, 18, 20, 21 |
| 4 | 11/08 | Updates to the <i>Electrical Characteristics</i> table and notes section. | 5, 14 |

Maxim cannot assume responsibility for use of any circuitry other than circuitry entirely embodied in a Maxim product. No circuit patent licenses are implied. Maxim reserves the right to change the circuitry and specifications without notice at any time.

20 _____ **Maxim Integrated Products, 120 San Gabriel Drive, Sunnyvale, CA 94086 408-737-7600**