

Typical Application

The HMC1043LC3 is ideal for:

- Ka-band Transponders
- Point-to-Multi-Point Radios & VSAT
- Test Equipment & Sensors
- Military End-Use

Features

- Passive: No DC Bias Required
- High Input IP3: 23 dBm
- High LO/RF Isolation: 45 dB
- High 2LO/IF Isolation: 50 dBm
- Wide IF Bandwidth: 16 - 22 GHz
- Upconverter & Downconverter Applications
- 16 Lead Ceramic 3x3 mm SMT Package: 9 mm²

Functional Diagram

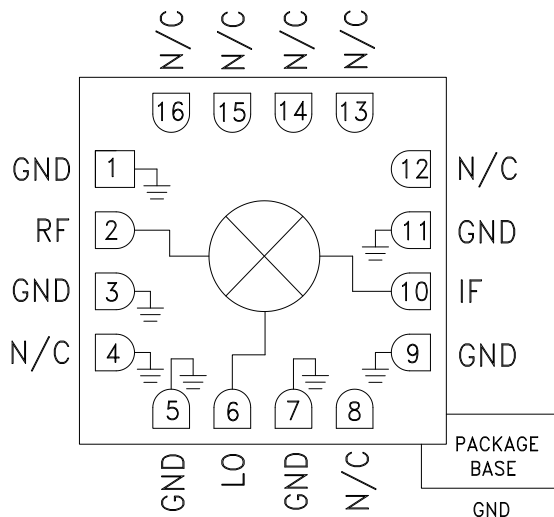

General Description

The HMC1043LC3 is a general purpose triple balanced mixer that can be used as a frequency converter with 16 to 22 GHz at the IF port and 26 to 32 GHz at the RF port. This mixer requires no external components or matching circuitry. The HMC1043LC3 provides excellent LO/RF, LO/IF and 2LO/IF isolation due to optimized balun structures. The mixer operates with LO drive levels from +9 dBm to +15dBm. The HMC1043LC3 eliminates the need for wire bonding and allows the use of surface mount manufacturing techniques.

Electrical Specifications, $T_A = +25\text{ }^\circ\text{C}$, LO = 9 GHz, LO = +13 dBm^[1]

Parameter	Min.	Typ.	Max.	Units
RF Frequency Range		26 - 32		GHz
IF Frequency Range		16- 22		GHz
LO Frequency Range		7 - 11		GHz
Conversion Loss		10	13	dB
LO to RF Isolation ^[2]		45		dB
LO to IF Isolation ^[2]		32		dB
2LO to IF Isolation ^[2]		50		dB
RF to IF Isolation		38		dB
IP3 (Input)		23		dBm
1 dB Gain Compression (Input)		10		dBm

[1] Unless otherwise noted all measurements performed as an upconverter.

[2] Fixed IF = 17 GHz.



**GaAs MMIC FUNDAMENTAL
MIXER, 29 - 32 GHz**

**Conversion Gain vs. Temperature
Upconverter, LO= 7 GHz**

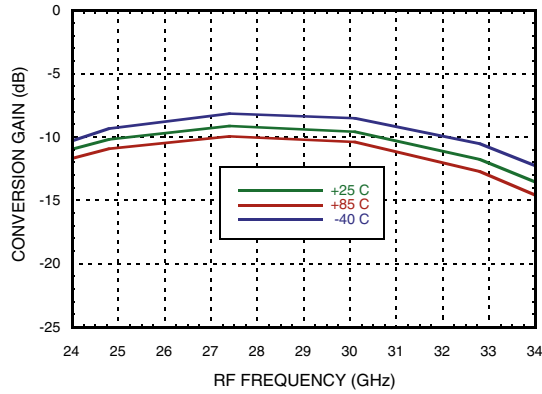

**Conversion Gain vs. Temperature
Upconverter, LO= 9 GHz**

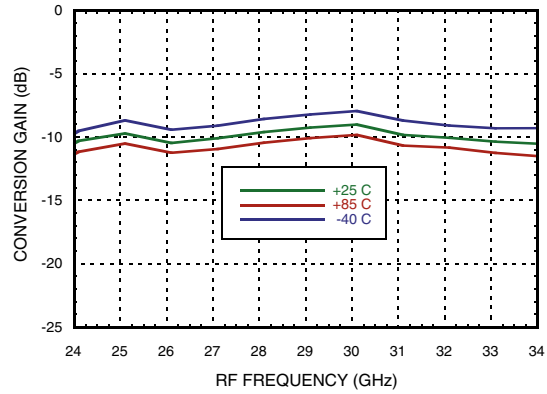

**Conversion Gain vs. Temperature
Upconverter, LO= 11 GHz**

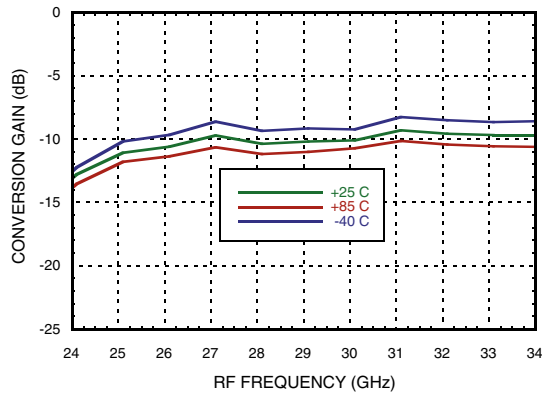

**Conversion Gain vs. LO Power
Upconverter, LO= 7 GHz**

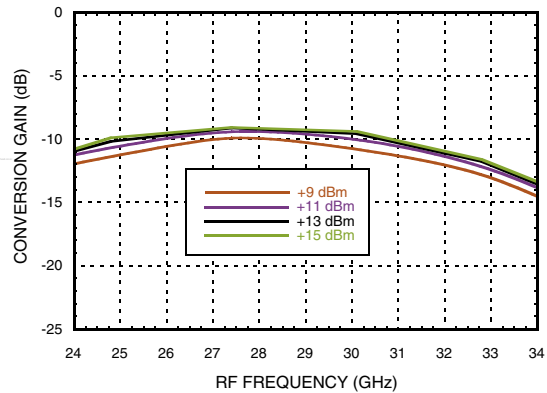

**Conversion Gain vs. LO Power
Upconverter, LO= 9 GHz**

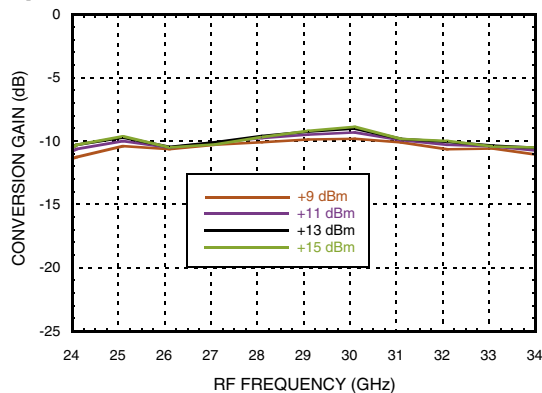

**Conversion Gain vs. LO Power
Upconverter, LO= 11 GHz**

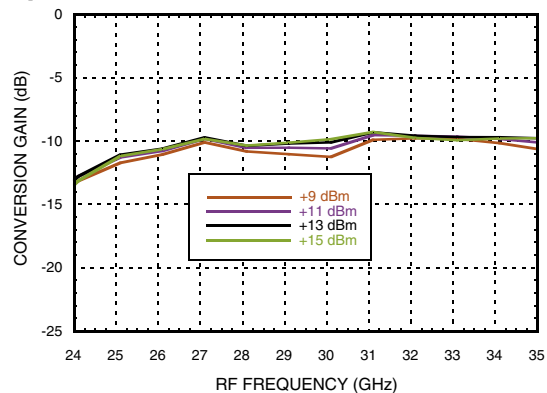

MIXER - TRIPLE-BALANCED - SMT



GaAs MMIC FUNDAMENTAL MIXER, 29 - 32 GHz

MIXER - TRIPLE-BALANCED - SMT

Input IP3 vs. Temperature Upconverter, LO= 7 GHz

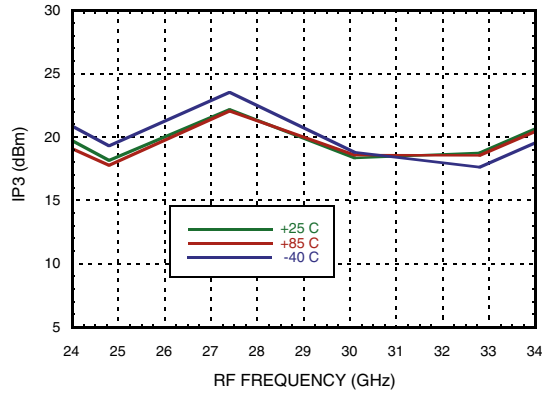

Input IP3 vs. Temperature Upconverter, LO= 9 GHz

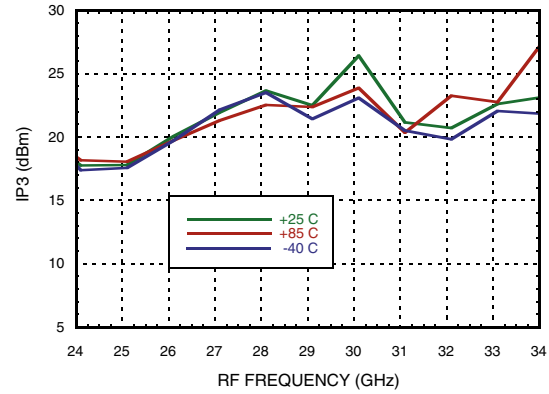

Input IP3 vs. Temperature Upconverter, LO= 11 GHz

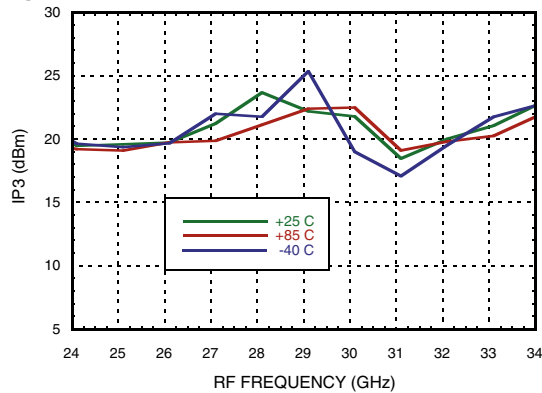

Input IP3 vs. LO Power Upconverter, LO= 7 GHz

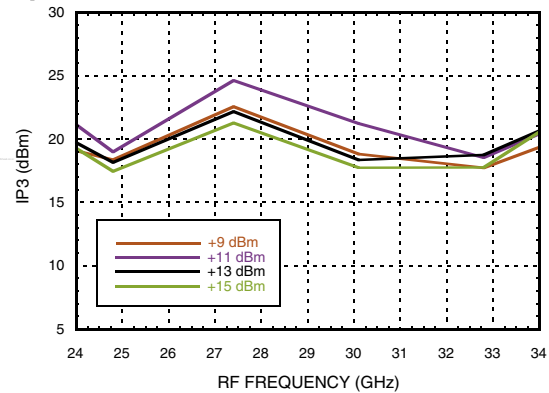

Input IP3 vs. LO Power Upconverter, LO= 9 GHz

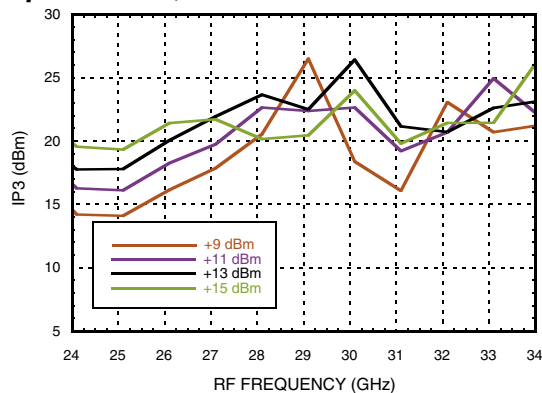

Input IP3 vs. LO Power Upconverter, LO= 11 GHz

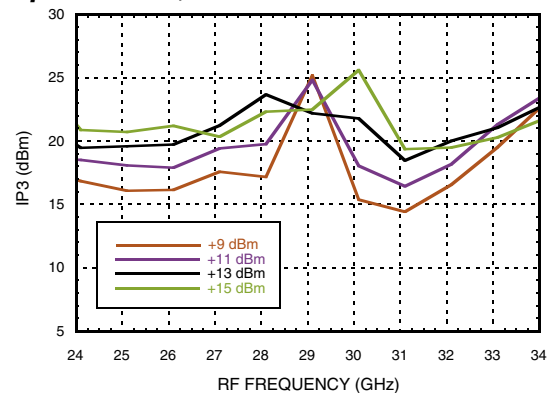



GaAs MMIC FUNDAMENTAL MIXER, 29 - 32 GHz

RF and IF Return Loss

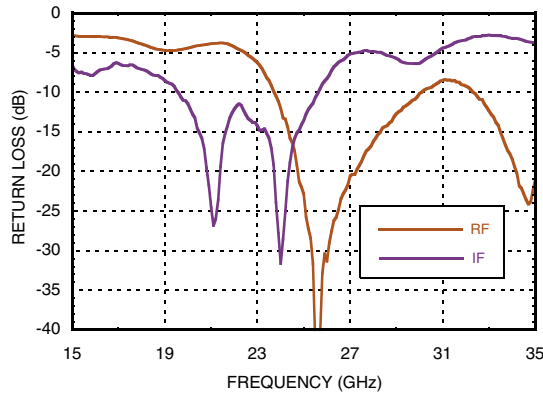

LO Return Loss

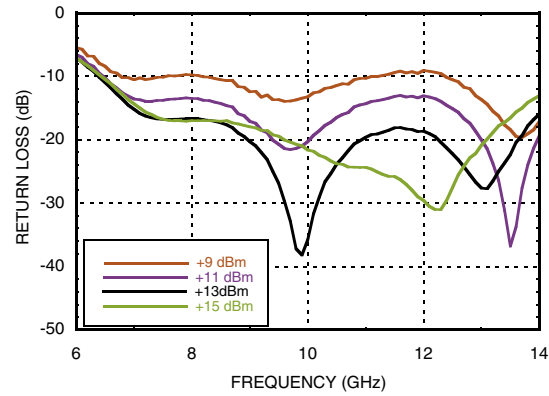

Isolation LO/IF, LO/RF, 2LO/IF

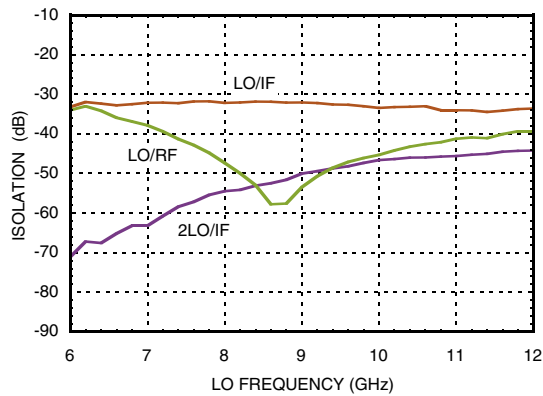

Isolation RF/IF

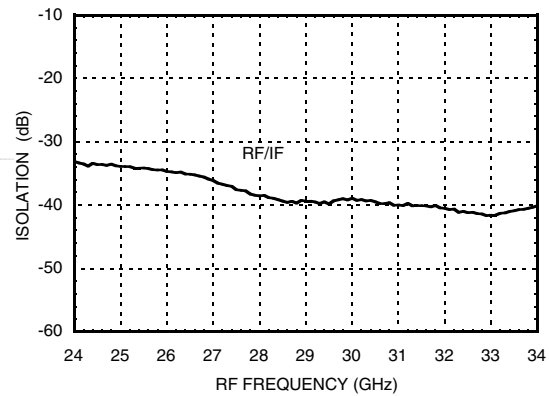

Input P1dB vs. Temperature @ LO= 9 GHz

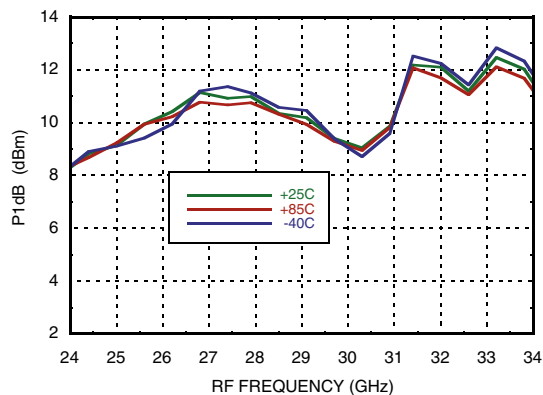

Input P1dB vs. LO Power @ LO= 9 GHz

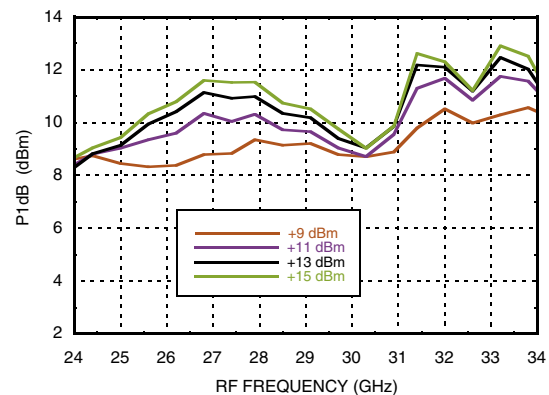

Harmonics of LO

LO Freq. (GHz)	nLO Spur at RF Port			
	1	2	3	4
5	44.64	58.77	58.11	53.59
6	33.41	41.23	62.4	36.69
7	37.68	35.88	52.15	35.92
8	45.93	35.38	53.02	37.53
9	52.07	38.59	53.75	44.9
10	43.98	41.39	56.39	55.45
11	41.05	48.29	58.23	69.13
12	40.24	40.36	53.27	68.1
13	38.96	33.73	50.12	X
14	36.52	34.19	52.84	X
15	36.77	35.25	47.77	X

LO = + 13 dBm
Values in dBc below LO level measured at RF Port.

Harmonics of LO

LO Freq. (GHz)	nLO Spur at RF Port			
	1	2	3	4
5	51.31	65.34	67.53	61.91
6	33.4	40.79	64.37	42
7	35.52	34053	52.4	37.18
8	41.82	33.64	52.57	38.14
9	51.78	36.7	53.25	48.7
10	44.38	39.35	55.72	59.39
11	40.67	47.34	59.58	66.13
12	39.62	39.59	54.12	62.85
13	38.29	33.31	50.77	X
14	35.73	33.7	54.37	X
15	35.99	34.44	49.26	X

LO = + 11 dBm
Values in dBc below LO level measured at RF Port.

Harmonics of LO

LO Freq. (GHz)	nLO Spur at RF Port			
	1	2	3	4
5	53.65	72.42	79.72	75.47
6	34.87	42.68	68.91	39.55
7	34.13	33.68	53.77	42.48
8	38.67	32.09	52.99	39.56
9	46.35	34.74	53.73	62.72
10	44.63	37.33	56.47	71.66
11	40.21	46.128	63.39	64.91
12	39	39.23	56.69	59.77
13	37.6	32.91	52.2	X
14	34.93	33.24	56.23	X
15	35.23	33.6	52.44	X

LO = + 9 dBm
Values in dBc below LO level measured at RF Port.

**MxN Spurious Outputs,
Downconverter**

mRF	nLO				
	0	1	2	3	4
0		-0.7	33.3	-2.3	28.4
1	26.4		37.1	30.3	95.8
2	X	70	66.9	58.5	68.9

RF = 28.1 GHz @ -10 dBm
LO = 7 GHz @ +11 dBm
All values in dBc below RF power level

**MxN Spurious Outputs,
Downconverter**

mRF	nLO				
	0	1	2	3	4
0		-0.1	20.8	5.9	36.9
1	28.9		42.7	53.6	53
2	X	X	71	56.6	69.7

RF = 30.1 GHz @ -10 dBm
LO = 9 GHz @ +11 dBm
All values in dBc below RF power level

**MxN Spurious Outputs,
Downconverter**

mRF	nLO				
	0	1	2	3	4
0		1.6	16.2	22.3	47.4
1	30		44.6	53.6	46.6
2	X	X	74.8	60.3	68.4
3	X	X	X	X	71.4

RF = 31.1 GHz @ -10 dBm
LO = 11 GHz @ +11 dBm
All values in dBc below RF power level

**MxN Spurious Outputs,
Downconverter**

mRF	nLO				
	0	1	2	3	4
0		-2	16.3	25.5	X
1	30.2		50.5	35.5	55.9
2	X	X	75	62.3	69
3	X	X	X	X	70.9

RF = 33.1 GHz @ -10 dBm
LO = 13 GHz @ +11 dBm
All values in dBc below RF power level

**MxN Spurious Outputs,
Upconverter**

mIF	nLO				
	0	1	2	3	4
0		4.7	3.4	21.3	6.1
1	23.5		52	23.2	45.9
2	5.2	68	X	X	X

IF = 21.1 GHz @ -10 dBm
LO = 7 GHz @ +11 dBm
All values in dBc below IF power level

**MxN Spurious Outputs,
Upconverter**

mIF	nLO				
	0	1	2	3	4
0		21.5	6.4	23	17.8
1	24.1		4.7	36.7	X
2	53.5	X	X	X	X

IF = 21.1 GHz @ -10 dBm
LO = 9 GHz @ +11 dBm
All values in dBc below IF power level

**MxN Spurious Outputs,
Upconverter**

mIF	nLO				
	0	1	2	3	4
0		1.1	16.7	28.9	34.9
1	25.1		47.1X	X	X
2	52.6	X	X	X	X

IF = 20.1 GHz @ -10 dBm
LO = 11 GHz @ +11 dBm
All values in dBc below IF power level

**MxN Spurious Outputs,
Upconverter**

mIF	nLO				
	0	1	2	3	4
0		7.1	2.1	19.6	X
1	25.7		44.9	X	X
2	51.4	X	X	X	X

IF = 20.1 GHz @ -10 dBm
LO = 13 GHz @ +11 dBm
All values in dBc below IF power level

**ELECTROSTATIC SENSITIVE DEVICE
OBSERVE HANDLING PRECAUTIONS**
Absolute Maximum Ratings

RF / IF Input(LO = +18 dBm)	+15.5 dBm
LO Drive	+20 dBm
Channel Temperature	150°C
Continuous P _{diss} (T=85°C) (derate 2.5 mW/°C above 85°C)	160 mW
Thermal Resistance (R _{TH}) (junction to package bottom)	394°C/W
Storage Temperature	-65 to +150 °C
Operating Temperature	-55 to +85 °C
ESD Sensitivity (HBM)	Class 1A

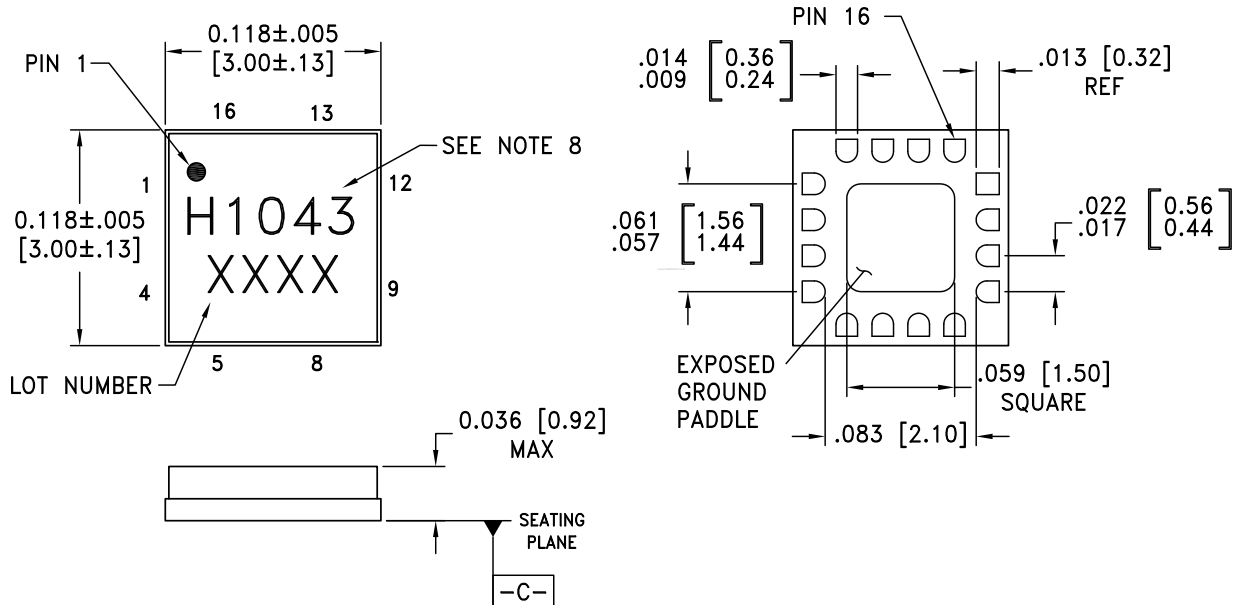
Outline Drawing

NOTES:

1. PACKAGE BODY MATERIAL: ALUMINA
2. LEAD AND GROUND PADDLE PLATING: 30-80 MICROINCHES GOLD OVER 50 MICROINCHES MINIMUM NICKEL.
3. DIMENSIONS ARE IN INCHES [MILLIMETERS].
4. LEAD SPACING TOLERANCE IS NON-CUMULATIVE.
5. CHARACTERS TO BE BLACK INK MARKED WITH .018"MIN TO .030"MAX HEIGHT REQUIREMENTS. UTILIZE MAXIMUM CHARACTER HEIGHT BASED ON LID DIMENSIONS AND BEST FIT. LOCATE APPROX. AS SHOWN.
6. PACKAGE WARP SHALL NOT EXCEED 0.05mm DATUM -C-
7. ALL GROUND LEADS AND GROUND PADDLE MUST BE SOLDERED TO PCB RF GROUND.

Package Information

Part Number	Package Body Material	Lead Finish	MSL Rating	Package Marking ^[2]
HMC1043LC3	Alumina, White	Gold over Nickel	MSL1 ^[1]	H1043 XXXX

[1] Max peak reflow temperature of 260 °C

[2] 4-Digit lot number XXXX

Pin Descriptions

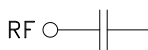
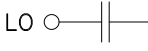
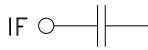
Pin Number	Function	Description	Interface Schematic
1, 3, 5, 7, 10, 11	GND	These pins and the exposed ground paddle must be connected to RF/DC ground.	
2	RF	This pad is AC coupled and matched to 50 Ohms.	
4, 8, 9, 12-16	N/C	No connection required. These pins are not connected internally: However, all data shown herein was measured with these pins connected to ground.	
6	LO	This pad is AC coupled and matched to 50 Ohms	
10	IF	This pad is AC coupled and matched to 50 Ohms	

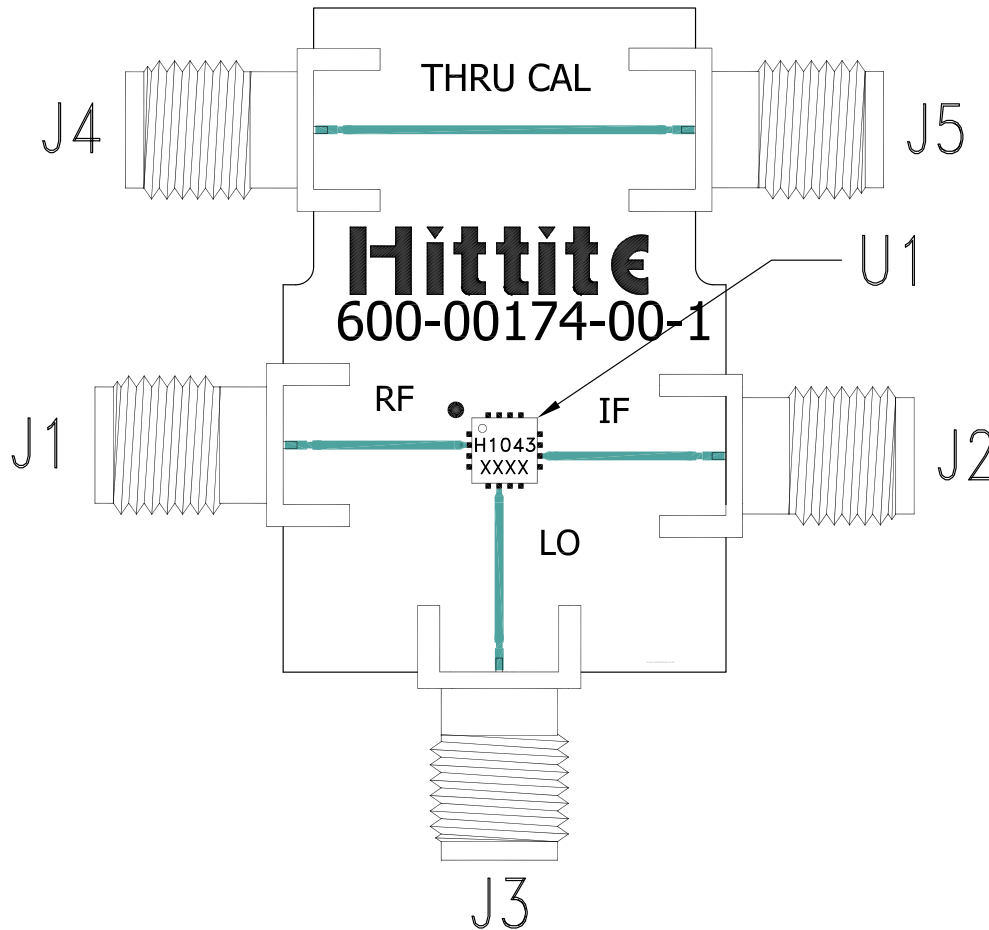
Evaluation PCB

List of Materials for Evaluation PCB EVAL01-HMC1043LC3 [1]

Item	Description
J1-J5	PCB Mount 2.9 mm K Connector, SRI
U1	HMC1043LC3
PCB [2]	109996-1 Evaluation Board

[1] Reference this number when ordering complete evaluation PCB

[2] Circuit Board Material: Rogers 4350

The circuit board used in the application should use RF circuit design techniques. Signal lines should have 50 Ohm impedance while the package ground leads and exposed paddle should be connected directly to the ground plane similar to that shown. A sufficient number of via holes should be used to connect the top and bottom ground planes. The evaluation circuit board shown is available from Hittite upon request.



Notes