

## Three Phase Bridge (Power Module), 45 A to 100 A

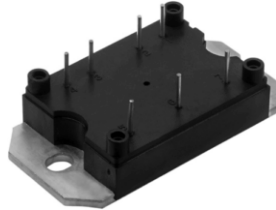

MT...PA



MT...PB

### FEATURES

- Low  $V_F$
- Low profile package
- Direct mounting to heatsink
- Flat pin/round pin versions with PCB solderable terminals
- Low junction to case thermal resistance
- 3500  $V_{RMS}$  insulation voltage
- UL approved file E78996 
- Compliant to RoHS directive 2002/95/EC
- Designed and qualified for industrial level



**RoHS**  
COMPLIANT

### APPLICATIONS

- Power conversion machines
- Welding
- UPS
- SMPS
- Motor drives
- General purpose and heavy duty application

### PRODUCT SUMMARY

$I_o$	45 A to 100 A
-------	---------------

### DESCRIPTION

A range of extremely compact three-phase rectifier bridges offering efficient and reliable operation. The low profile package has been specifically conceived to maximize space saving and optimize the electrical layout of the application specific power supplies.

### MAJOR RATINGS AND CHARACTERISTICS

SYMBOL	CHARACTERISTICS	40MT	70MT	100MT	UNITS
$I_o$		45	75	100	A
	$T_C$	100	80	80	$^{\circ}C$
$I_{FSM}$	50 Hz	270	380	450	A
	60 Hz	280	398	470	
$I^2t$	50 Hz	365	724	1013	$A^2s$
	60 Hz	325	660	920	
$I^2\sqrt{t}$		3650	7240	10 130	$A^2\sqrt{s}$
$V_{RRM}$		1400 to 1600			V
$T_{Stg}$	Range	- 40 to 125			$^{\circ}C$
$T_J$		- 40 to 150			

# 40MT1.0P.PbF, 70MT1.0P.PbF, 100MT1.0P.PbF Series



Vishay High Power Products Three Phase Bridge  
(Power Module), 45 A to 100 A

## ELECTRICAL SPECIFICATIONS

VOLTAGE RATINGS				
TYPE NUMBER	VOLTAGE CODE REVERSE VOLTAGE V	V <sub>RRM</sub> , MAXIMUM REPETITIVE PEAK REVERSE VOLTAGE V	V <sub>RSM</sub> , MAXIMUM NON-REPETITIVE PEAK V	I <sub>RRM</sub> MAXIMUM AT T <sub>J</sub> = 150 °C mA
40MT140P, 70MT140P, 100MT140P	140	1400	1500	5
40MT160P, 70MT160P, 100MT160P	160	1600	1700	

FORWARD CONDUCTION								
PARAMETER	SYMBOL	TEST CONDITIONS		40MT	70MT	100MT	UNITS	
Maximum DC output current at case temperature	I <sub>O</sub>	120° rect. to conduction angle		45	75	100	A	
				100	80	80	°C	
Maximum peak, one cycle forward, non-repetitive on state surge current	I <sub>FSM</sub>	t = 10 ms	No voltage reapplied	Initial T <sub>J</sub> = T <sub>J</sub> maximum	270	380	450	A
		t = 8.3 ms			280	398	470	
		t = 10 ms	100 % V <sub>RRM</sub> reapplied		225	320	380	
		t = 8.3 ms			240	335	400	
Maximum I <sup>2</sup> t for fusing	I <sup>2</sup> t	t = 10 ms	No voltage reapplied	Initial T <sub>J</sub> = T <sub>J</sub> maximum	365	724	1013	A <sup>2</sup> s
		t = 8.3 ms			325	660	920	
		t = 10 ms	100 % V <sub>RRM</sub> reapplied		253	512	600	
		t = 8.3 ms			240	467	665	
Maximum I <sup>2</sup> √t for fusing	I <sup>2</sup> √t	t = 0.1 ms to 10 ms, no voltage reapplied		3650	7240	10 130	A <sup>2</sup> √s	
Value of threshold voltage	V <sub>F(TO)</sub>	T <sub>J</sub> maximum		0.78	0.82	0.75	V	
Slope resistance	r <sub>t</sub>			14.8	9.5	8.1	mΩ	
Maximum forward voltage drop	V <sub>FM</sub>	T <sub>J</sub> = 25 °C; t <sub>p</sub> = 400 μs single junction (40MT, I <sub>pk</sub> = 40 A) (70MT, I <sub>pk</sub> = 70 A) (100MT, I <sub>pk</sub> = 100 A)		1.45	1.45	1.51	V	

INSULATION TABLE						
PARAMETER	SYMBOL	TEST CONDITIONS	40MT	70MT	100MT	UNITS
RMS insulation voltage	V <sub>INS</sub>	T <sub>J</sub> = 25 °C, all terminal shorted, f = 50 Hz, t = 1 s	3500			V

THERMAL AND MECHANICAL SPECIFICATIONS						
PARAMETER	SYMBOL	TEST CONDITIONS	40MT	70MT	100MT	UNITS
Maximum junction operating temperature range	T <sub>J</sub>		- 40 to 150			°C
Maximum storage temperature range	T <sub>Stg</sub>		- 40 to 125			
Maximum thermal resistance, junction to case	R <sub>thJC</sub>	DC operation per module	0.27	0.23	0.19	K/W
		DC operation per junction	1.6	1.38	1.14	
		120° rect. conduction angle per module	0.38	0.29	0.22	
		120° rect. conduction angle per junction	2.25	1.76	1.29	
Maximum thermal resistance, case to heatsink per module	R <sub>thCS</sub>	Mounting surface smooth, flat and greased Heatsink compound thermal conductivity = 0.42 W/mK	0.1			
Mounting torque to heatsink ± 10 %		A mounting compound is recommended and the torque should be rechecked after a period of 3 hours to allow for the spread of the compound.	4			Nm
Approximate weight		Lubricated threads	65			g



# 40MT1.0P.PbF, 70MT1.0P.PbF, 100MT1.0P.PbF Series

Three Phase Bridge Vishay High Power Products  
(Power Module), 45 A to 100 A

CLEARANCE AND CREEPAGE DISTANCES				
PARAMETER	TEST CONDITIONS	MT...PA	MT...PB	UNITS
Clearance	External shortest distances in air between terminals which are not internally short circuited together	10.9	12.3	mm
Creepage distance				

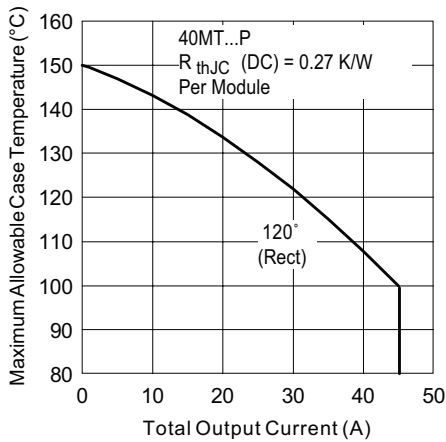

Fig. 1 - Current Rating Characteristics

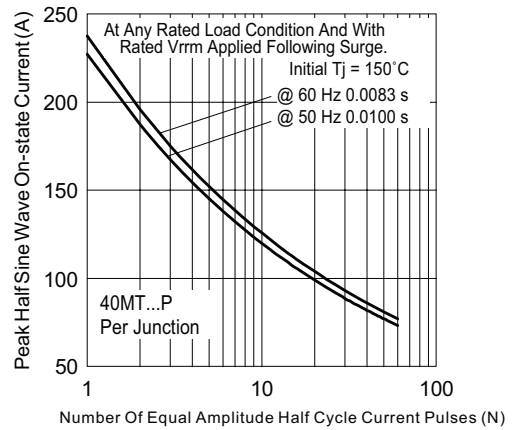

Fig. 3 - Maximum Non-Repetitive Surge Current

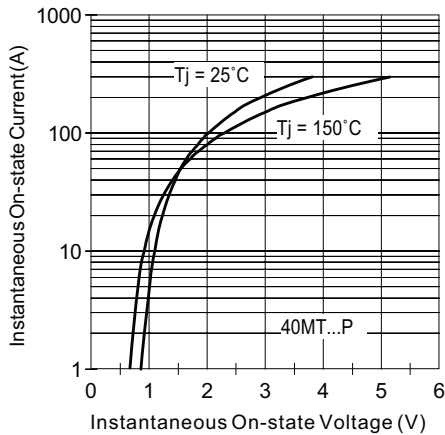

Fig. 2 - On-State Voltage Drop Characteristics

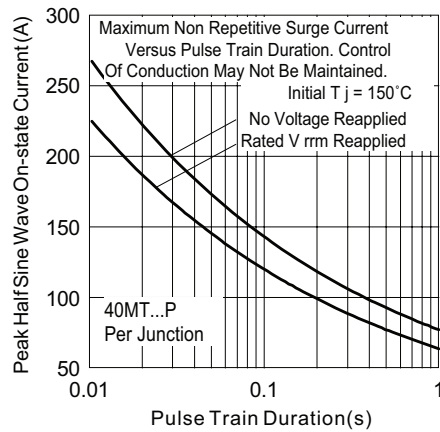

Fig. 4 - Maximum Non-Repetitive Surge Current

# 40MT1.0P.PbF, 70MT1.0P.PbF, 100MT1.0P.PbF Series



Vishay High Power Products Three Phase Bridge  
(Power Module), 45 A to 100 A

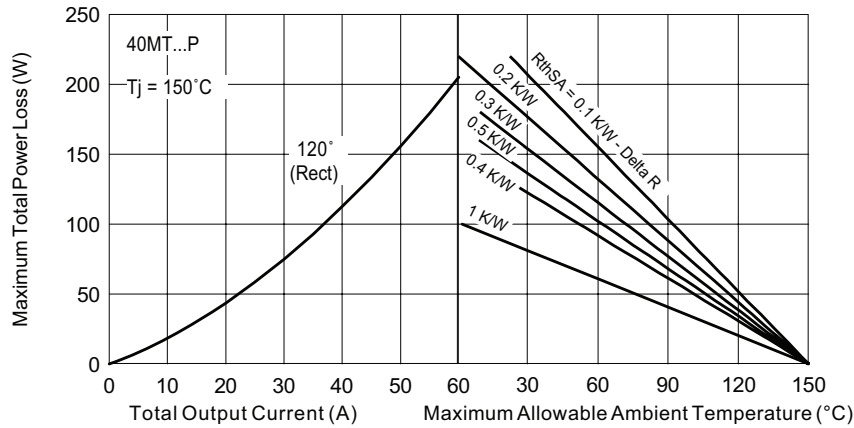

Fig. 5 - Current Rating Nomogram (1 Module Per Heatsink)

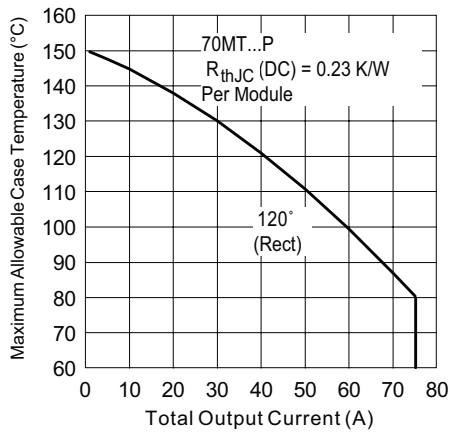

Fig. 6 - Current Rating Characteristics

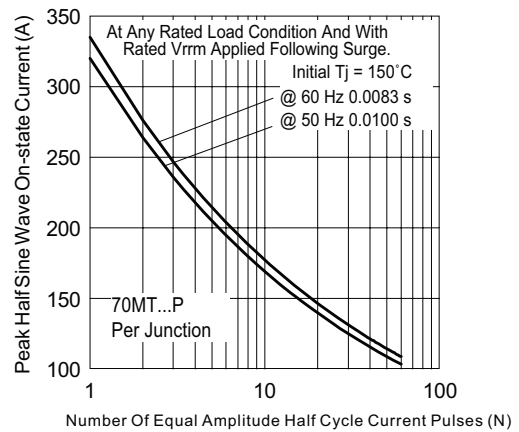

Fig. 8 - Maximum Non-Repetitive Surge Current

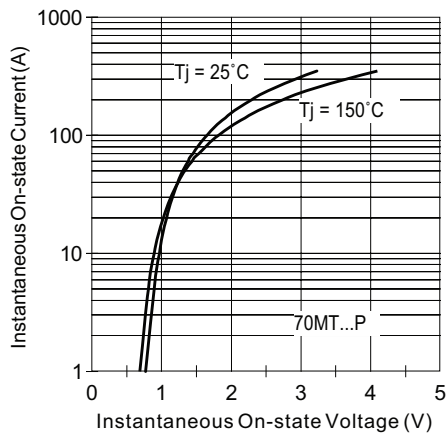

Fig. 7 - On-State Voltage Drop Characteristics

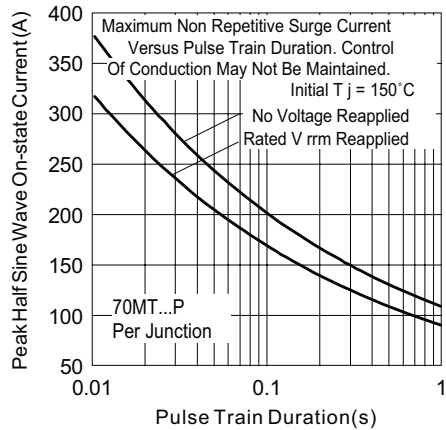

Fig. 9 - Maximum Non-Repetitive Surge Current



# 40MT1.0P.PbF, 70MT1.0P.PbF, 100MT1.0P.PbF Series

Three Phase Bridge Vishay High Power Products  
(Power Module), 45 A to 100 A

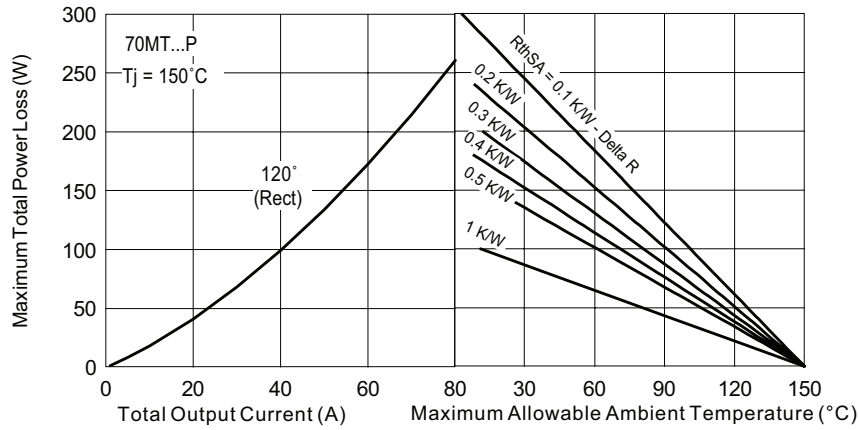

Fig. 10 - Current Rating Nomogram (1 Module Per Heatsink)

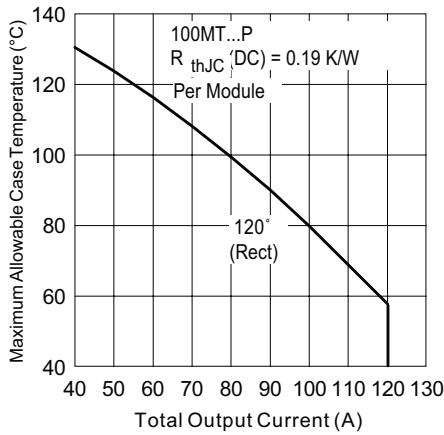

Fig. 11 - Current Rating Characteristics

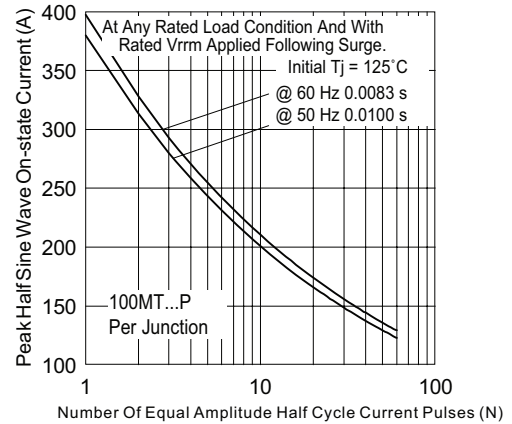

Fig. 13 - Maximum Non-Repetitive Surge Current

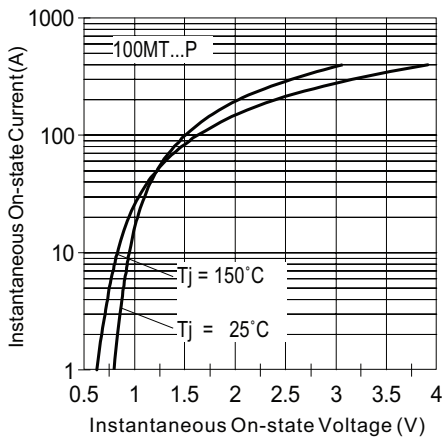

Fig. 12 - On-State Voltage Drop Characteristics

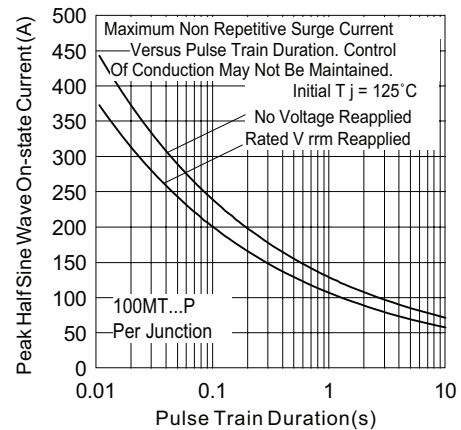

Fig. 14 - Maximum Non-Repetitive Surge Current

# 40MT1.0P.PbF, 70MT1.0P.PbF, 100MT1.0P.PbF Series



Vishay High Power Products Three Phase Bridge  
(Power Module), 45 A to 100 A

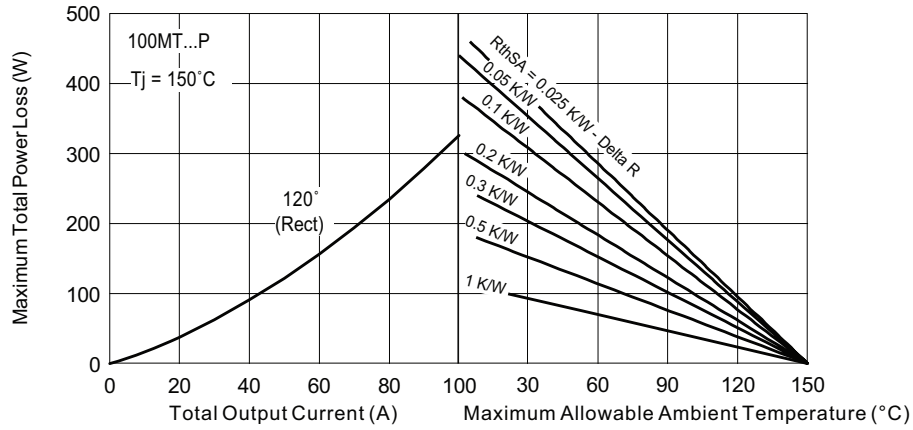

Fig. 15 - Current Rating Nomogram (1 Module Per Heatsink)

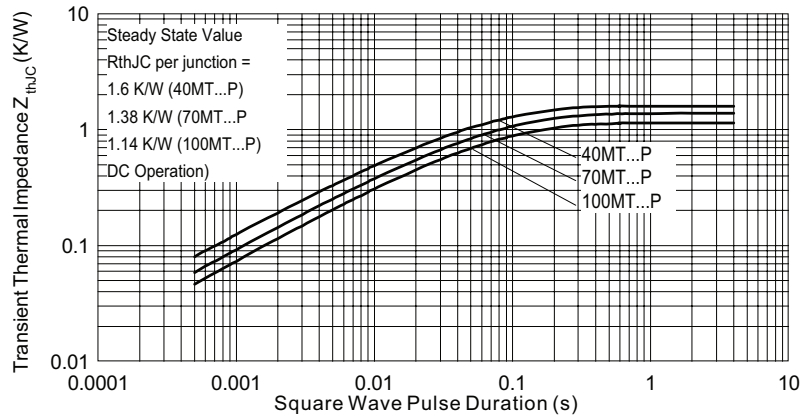

Fig. 16 - Thermal Impedance  $Z_{thJC}$  Characteristics



# 40MT1.0P.PbF, 70MT1.0P.PbF, 100MT1.0P.PbF Series

Three Phase Bridge Vishay High Power Products  
(Power Module), 45 A to 100 A

## ORDERING INFORMATION TABLE

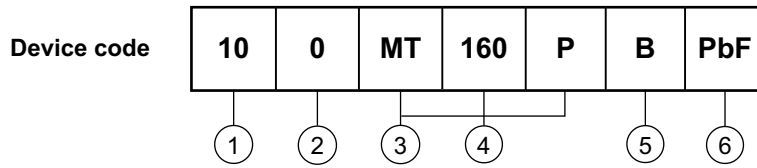

1

- Current rating code

4 = 45 A
7 = 75 A
10 = 100 A

2

- Circuit configuration code: 0 = 3-Phase rectifier bridge

3

- Essential part number

4

- Voltage code x 10 =  $V_{RRM}$  (see Voltage Ratings table)

5

- Pinout code

A = Flat pins
B = Round pins

6

- Lead (Pb)-free

## CIRCUIT CONFIGURATION

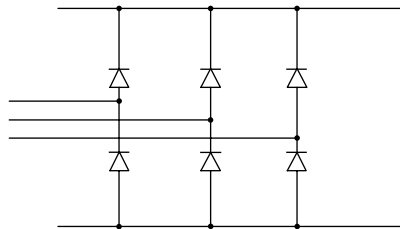

## LINKS TO RELATED DOCUMENTS

Dimensions

[www.vishay.com/doc?95244](http://www.vishay.com/doc?95244)

## MTP Flat and Round Pin

### DIMENSIONS FOR MTP WITH FLAT PIN in millimeters

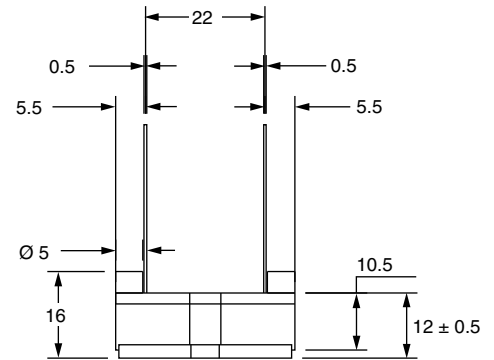
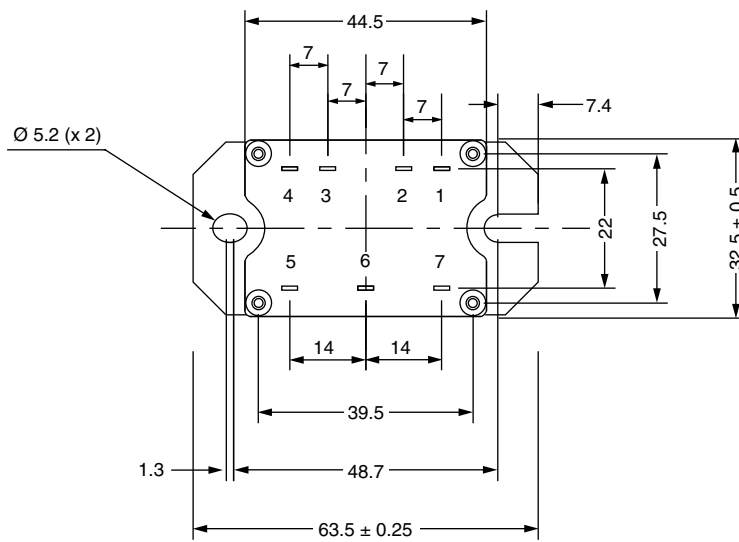
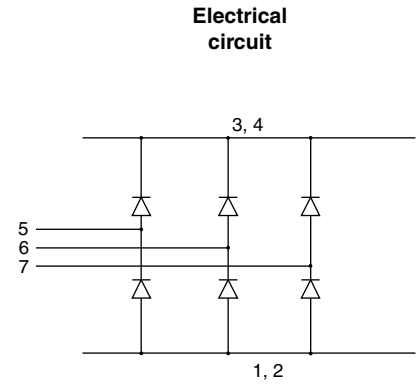
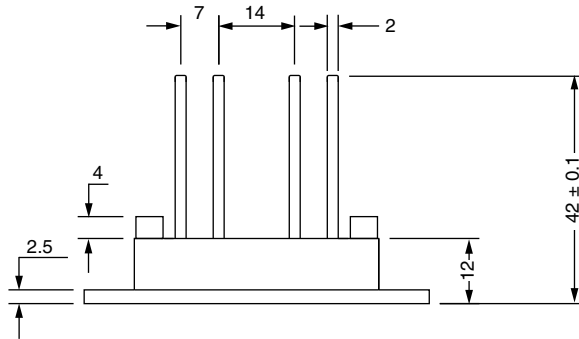



# Outline Dimensions

Vishay Semiconductors

MTP Flat and Round Pin



## DIMENSIONS FOR MTP WITH ROUND PIN in millimeters

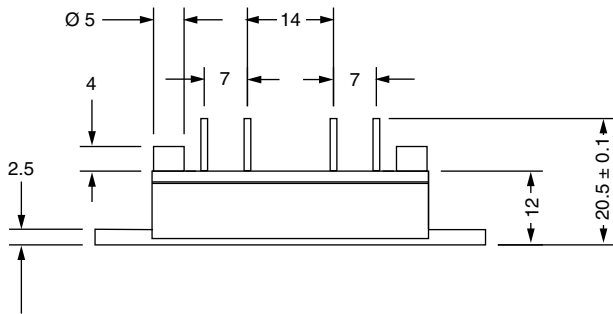

Electrical circuit

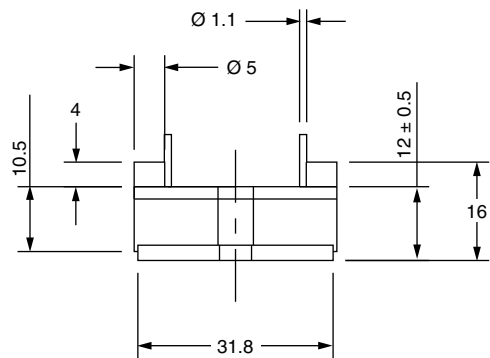
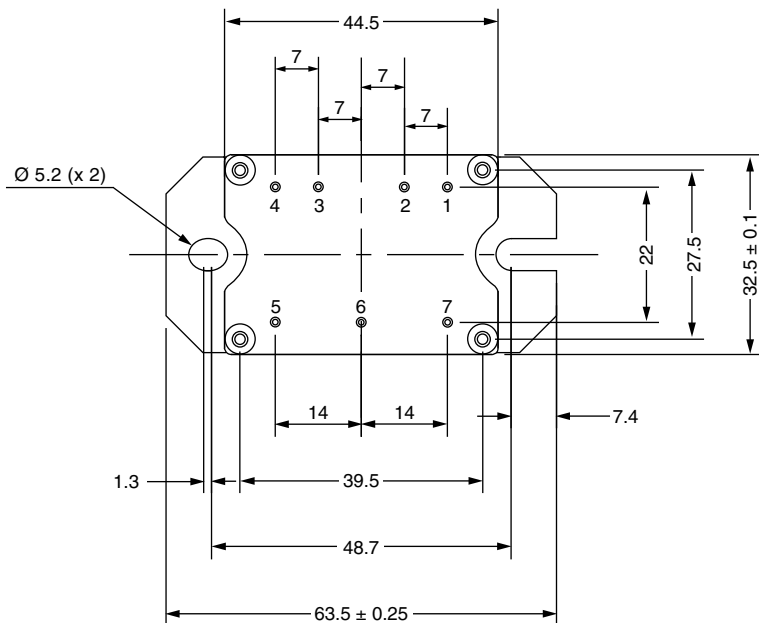
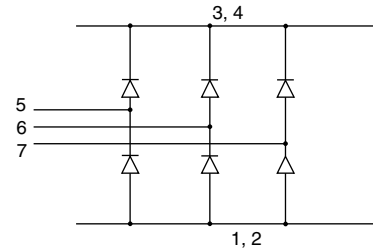



## Disclaimer

ALL PRODUCT, PRODUCT SPECIFICATIONS AND DATA ARE SUBJECT TO CHANGE WITHOUT NOTICE TO IMPROVE RELIABILITY, FUNCTION OR DESIGN OR OTHERWISE.

Vishay Intertechnology, Inc., its affiliates, agents, and employees, and all persons acting on its or their behalf (collectively, "Vishay"), disclaim any and all liability for any errors, inaccuracies or incompleteness contained in any datasheet or in any other disclosure relating to any product.

Vishay makes no warranty, representation or guarantee regarding the suitability of the products for any particular purpose or the continuing production of any product. To the maximum extent permitted by applicable law, Vishay disclaims (i) any and all liability arising out of the application or use of any product, (ii) any and all liability, including without limitation special, consequential or incidental damages, and (iii) any and all implied warranties, including warranties of fitness for particular purpose, non-infringement and merchantability.

Statements regarding the suitability of products for certain types of applications are based on Vishay's knowledge of typical requirements that are often placed on Vishay products in generic applications. Such statements are not binding statements about the suitability of products for a particular application. It is the customer's responsibility to validate that a particular product with the properties described in the product specification is suitable for use in a particular application. Parameters provided in datasheets and/or specifications may vary in different applications and performance may vary over time. All operating parameters, including typical parameters, must be validated for each customer application by the customer's technical experts. Product specifications do not expand or otherwise modify Vishay's terms and conditions of purchase, including but not limited to the warranty expressed therein.

Except as expressly indicated in writing, Vishay products are not designed for use in medical, life-saving, or life-sustaining applications or for any other application in which the failure of the Vishay product could result in personal injury or death. Customers using or selling Vishay products not expressly indicated for use in such applications do so at their own risk and agree to fully indemnify and hold Vishay and its distributors harmless from and against any and all claims, liabilities, expenses and damages arising or resulting in connection with such use or sale, including attorneys fees, even if such claim alleges that Vishay or its distributor was negligent regarding the design or manufacture of the part. Please contact authorized Vishay personnel to obtain written terms and conditions regarding products designed for such applications.

No license, express or implied, by estoppel or otherwise, to any intellectual property rights is granted by this document or by any conduct of Vishay. Product names and markings noted herein may be trademarks of their respective owners.

## Material Category Policy

**Vishay Intertechnology, Inc. hereby certifies that all its products that are identified as RoHS-Compliant fulfill the definitions and restrictions defined under Directive 2011/65/EU of The European Parliament and of the Council of June 8, 2011 on the restriction of the use of certain hazardous substances in electrical and electronic equipment (EEE) - recast, unless otherwise specified as non-compliant.**

**Please note that some Vishay documentation may still make reference to RoHS Directive 2002/95/EC. We confirm that all the products identified as being compliant to Directive 2002/95/EC conform to Directive 2011/65/EU.**