

DUAL ULTRA MICROPOWER RAIL-TO-RAIL CMOS OPERATIONAL AMPLIFIER

GENERAL DESCRIPTION

The ALD2706A/ALD2706B/ALD2706 is a dual monolithic CMOS micropower high slew-rate operational amplifier intended for a broad range of analog applications using $\pm 1V$ to $\pm 5V$ dual power supply systems, as well as +2V to +10V battery operated systems. All device characteristics are specified for +5V single supply or $\pm 2.5V$ dual supply systems. Supply current is 80 μA maximum at 5V supply voltage. It is manufactured with Advanced Linear Devices' enhanced A CMOS silicon gate CMOS process.

The ALD2706A/ALD2706B/ALD2706 is designed to offer a trade-off of performance parameters providing a wide range of desired specifications. It has been developed specifically for the +5V single supply or $\pm 1V$ to $\pm 5V$ dual supply user and offers the popular industry standard pin configuration.

Several important characteristics of the device make application easier to implement at those voltages. First, each operational amplifier can operate with rail to rail input and output voltages. This means the signal input voltage and output voltage can be equal to the positive and negative supply voltages. This feature allows numerous analog serial stages and flexibility in input signal bias levels. Second, each device was designed to accommodate mixed applications where digital and analog circuits may operate off the same power supply or battery. Third, the output stage can typically drive up to 25pF capacitive and 20K Ω resistive loads. These features, combined with extremely low input currents, high open loop voltage gain of 100V/mV, useful bandwidth of 200KHz, a slew rate of 0.1V/ μs , low offset voltage and temperature drift, make the ALD2706A/ALD2706B/ALD2706 a versatile, micropower dual operational amplifier.

A typical ALD2706A/ALD2706B/ALD2706 has the capacity to process a 0.998V amplitude analog signal with only 1.000V single supply voltage, while requiring only 0.1pA input bias current. Additionally, robust design and rigorous screening make this device especially suitable for operation in temperature-extreme environments and rugged conditions.

FEATURES

- Typical 20 μA supply current per amplifier
- All parameters specified for +5V single supply or $\pm 2.5V$ dual supply systems
- Rail-to-rail input and output voltage ranges
- Unity gain stable
- Extremely low input bias currents -- 0.1pA
- High source impedance applications
- Dual power supply $\pm 1.0V$ to $\pm 5.0V$
- Single power supply +2V to +10V
- High voltage gain
- Unity gain bandwidth of 0.2MHz
- Slew rate of 0.1V/ μs
- Symmetrical output drive
- Suitable for rugged, temperature-extreme environments

APPLICATIONS

- Voltage follower/buffer/amplifier
- Charge integrator
- Photodiode amplifier
- Data acquisition systems
- High performance portable instruments
- Signal conditioning circuits
- Sensor and transducer amplifiers
- Low leakage amplifiers
- Active filters
- Sample/Hold amplifier
- Picoammeter
- Current to voltage converter

ORDERING INFORMATION ("L" suffix denotes lead-free (RoHS))

Operating Temperature Range		
0°C to +70°C	0°C to +70°C	-55°C to 125°C
8-Pin Small Outline Package (SOIC)	8-Pin Plastic Dip Package	8-Pin CERDIP Package
ALD2706ASAL	ALD2706APAL	ALD2706ADA
ALD2706BSAL	ALD2706BPAL	ALD2706BDA
ALD2706SAL	ALD2706PAL	ALD2706DA

* Contact factory for leaded (non-RoHS) or high temperature versions.

PIN CONFIGURATION

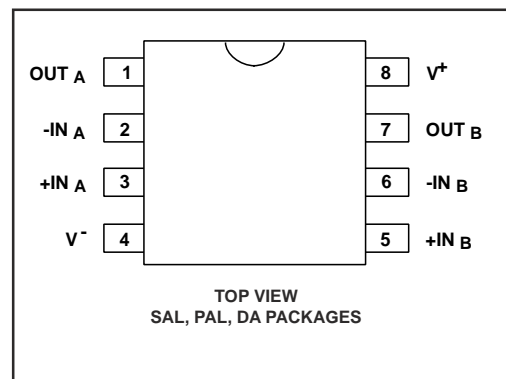

ABSOLUTE MAXIMUM RATINGS

Supply voltage, V_+ _____ 10.6V
 Differential input voltage range _____ -0.3V to V_+ +0.3V
 Power dissipation _____ 600 mW
 Operating temperature range SAL, PAL packages _____ 0°C to +70°C
 DA package _____ -55°C to +125°C
 Storage temperature range _____ -65°C to +150°C
 Lead temperature, 10 seconds _____ +260°C

CAUTION: ESD Sensitive Device. Use static control procedures in ESD controlled environment.

OPERATING ELECTRICAL CHARACTERISTICS

$T_A = 25^\circ\text{C}$ $V_S = \pm 2.5\text{V}$ unless otherwise specified

Parameter	Symbol	2706A			2706B			2706			Unit	Test Conditions
		Min	Typ	Max	Min	Typ	Max	Min	Typ	Max		
Supply Voltage	V_S	±1.0		±5.0	±1.0		±5.0	±1.0		±5.0	V	Dual Supply Single Supply
	V_+	2.0		10.0	2.0		10.0	2.0		10.0	V	
Input Offset Voltage	V_{OS}			2.0 2.8			5.0 5.8			10.0 11.0	mV mV	$R_S \leq 100\text{K}\Omega$ $0^\circ\text{C} \leq T_A \leq +70^\circ\text{C}$
Input Offset Current	I_{OS}		0.1	20 200		0.1	20 200		0.1	20 200	pA pA	$T_A = 25^\circ\text{C}$ $0^\circ\text{C} \leq T_A \leq +70^\circ\text{C}$
Input Bias Current	I_B		0.1	20 200		0.1	20 200		0.1	20 200	pA pA	$T_A = 25^\circ\text{C}$ $0^\circ\text{C} \leq T_A \leq +70^\circ\text{C}$
Input Voltage Range	V_{IR}	-0.3 -2.8		5.3 2.8	-0.3 -2.8		5.3 2.8	-0.3 -2.8		5.3 2.8	V V	$V_+ = +5$ $V_S = \pm 2.5\text{V}$
Input Resistance	R_{IN}		10^{12}			10^{12}			10^{12}		Ω	
Input Offset Voltage Drift	TCV_{OS}		7			7			10		$\mu\text{V}/^\circ\text{C}$	$R_S \leq 100\text{K}\Omega$
Power Supply Rejection Ratio	PSRR	65	80		65	80		60	80		dB	$R_S \leq 100\text{K}\Omega$ $0^\circ\text{C} \leq T_A \leq +70^\circ\text{C}$
		65	80		65	80		60	80		dB	
Common Mode Rejection Ratio	CMRR	65	83		65	83		60	83		dB	$R_S \leq 100\text{K}\Omega$ $0^\circ\text{C} \leq T_A \leq +70^\circ\text{C}$
		65	83		65	83		60	83		dB	
Large Signal Voltage Gain	A_v	10	100		10	100		5	80		V/mV	$R_L = 100\text{K}\Omega$ $R_L \geq 1\text{M}\Omega$ $R_L = 100\text{K}\Omega$ $0^\circ\text{C} \leq T_A \leq +70^\circ\text{C}$
		10	300		10	300		5	300		V/mV V/mV	
Output Voltage Range	$V_{O\text{ low}}$		0.001	0.01		0.001	0.01		0.001	0.01	V	$R_L = 1\text{M}\Omega$ $V_+ = +5\text{V}$ $0^\circ\text{C} \leq T_A \leq +70^\circ\text{C}$
	$V_{O\text{ high}}$	4.99	4.999		4.99	4.999		4.99	4.999		V	
Output Short Circuit Current	I_{SC}		-2.40	-2.25		-2.40	-2.25		-2.40	-2.25	V	$R_L = 100\text{K}\Omega$ $0^\circ\text{C} \leq T_A \leq +70^\circ\text{C}$
			2.25	2.40		2.25	2.40		2.25	2.40	V	
Output Short Circuit Current	I_{SC}		200			200			200		μA	
Supply Current	I_S		50	80		50	80		50	80	μA	$V_{IN}=0\text{V}$ No Load
Power Dissipation	P_D			400			400			400	μW	Both amplifiers $V_S = \pm 2.5\text{V}$

OPERATING ELECTRICAL CHARACTERISTICS (cont'd)

$T_A = 25^\circ\text{C}$ $V_S = \pm 2.5\text{V}$ unless otherwise specified

Parameter	Symbol	2706A			2706B			2706			Unit	Test Conditions
		Min	Typ	Max	Min	Typ	Max	Min	Typ	Max		
Input Capacitance	C_{IN}		1			1			1		pF	
Bandwidth	B_W		200			200			200		KHz	
Slew Rate	S_R		0.1			0.1			0.1		V/ μs	$A_V = +1$ $R_L = 100\text{K}\Omega$
Rise time	t_r		1.0			1.0			1.0		μs	$R_L = 100\text{K}\Omega$
Overshoot Factor			20			20			20		%	$R_L = 100\text{K}\Omega$ $C_L = 25\text{pF}$
Settling Time	t_s		10.0			10.0			10.0		μs	0.1% $A_V = -1$ $C_L = 25\text{pF}$ $R_L = 100\text{K}\Omega$
Channel Separation	C_S		140			140			140		dB	$A_V = 100$

$T_A = 25^\circ\text{C}$ $V_S = \pm 1.0\text{V}$ unless otherwise specified

Parameter	Symbol	2706A			2706B			2706			Unit	Test Conditions
		Min	Typ	Max	Min	Typ	Max	Min	Typ	Max		
Power Supply Rejection Ratio	PSRR		80			80			80		dB	$R_S \leq 1\text{M}\Omega$
Common Mode Rejection Ratio	CMRR		80			80			80		dB	$R_S \leq 1\text{M}\Omega$
Large Signal Voltage Gain	A_V		50			50			50		V/mV	$R_L = 1\text{M}\Omega$
Output Voltage Range	$V_{O\text{ low}}$ $V_{O\text{ high}}$	0.9	-0.95 0.95	-0.9	0.9	-0.95 0.95	-0.9	0.9	-0.95 0.95	-0.9	V V	$R_L = 1\text{M}\Omega$
Bandwidth	B_W		0.2			0.2			0.2		MHz	
Slew Rate	S_R		0.1			0.1			0.1		V/ μs	$A_V = +1$ $C_L = 25\text{pF}$

$V_S = \pm 2.5\text{V}$ $-55^\circ\text{C} \leq T_A \leq +125^\circ\text{C}$ unless otherwise specified

Parameter	Symbol	2706ADA			2706BDA			2706DA			Unit	Test Conditions
		Min	Typ	Max	Min	Typ	Max	Min	Typ	Max		
Input Offset Voltage	V_{OS}			3.0			6.0			12.0	mV	$R_S \leq 100\text{K}\Omega$
Input Offset Current	I_{OS}			4.0			4.0			4.0	nA	
Input Bias Current	I_B			4.0			4.0			4.0	nA	
Power Supply Rejection Ratio	PSRR	60	75		60	75		60	75		dB	$R_S \leq 1\text{M}\Omega$
Common Mode Rejection Ratio	CMRR	60	83		60	83		60	83		dB	$R_S \leq 1\text{M}\Omega$
Large Signal Voltage Gain	A_V	10	50		10	50		5	50		V/mV	$R_L = 1\text{M}\Omega$
Output Voltage Range	$V_{O\text{ low}}$ $V_{O\text{ high}}$	2.25	-2.40 2.40	-2.25	2.25	-2.40 2.40	-2.25	2.25	-2.40 2.40	-2.25	V V	$R_L = 1\text{M}\Omega$

Design & Operating Notes:

1. The ALD2706A/ALD2706B/ALD2706 CMOS operational amplifier uses a 3 gain stage architecture and an improved frequency compensation scheme to achieve large voltage gain, high output driving capability, and better frequency stability. In a conventional CMOS operational amplifier design, compensation is achieved with a pole splitting capacitor together with a nulling resistor. This method is, however, very bias dependent and thus cannot accommodate the large range of supply voltage operation as is required from a stand alone CMOS operational amplifier. The ALD2706A/ALD2706B/ALD2706 is internally compensated for unity gain stability using a novel scheme that does not use a nulling resistor. This scheme produces a clean single pole roll off in the gain characteristics while providing for more than 70 degrees of phase margin at the unity gain frequency.
2. The ALD2706A/ALD2706B/ALD2706 has complementary p-channel and n-channel input differential stages connected in parallel to accomplish rail to rail input common mode voltage range. This means that with the ranges of common mode input voltage close to the power supplies, one of the two differential stages is switched off internally. To maintain compatibility with other operational amplifiers, this switching point has been selected to be about 1.5V below the positive supply voltage. Since offset voltage trimming on the ALD2706A/ALD2706B/ALD2706 is made when the input voltage is symmetrical to the supply voltages, this internal switching does not affect a large variety of applications such as an inverting amplifier or non-inverting amplifier with a gain larger than 2.5 (5V operation), where the common mode voltage does not make excursions above this switching point. The user should however, be aware that this switching does take place if the operational amplifier is connected as a unity gain buffer and should make provision in his design to allow for input offset voltage variations.
3. The input bias and offset currents are essentially input protection diode reverse bias leakage currents, and are typically less than

1pA at room temperature. This low input bias current assures that the analog signal from the source will not be distorted by input bias currents. Normally, this extremely high input impedance of greater than $10^{12}\Omega$ would not be a problem as the source impedance would limit the node impedance. However, for applications where source impedance is very high, it may be necessary to limit noise and hum pickup through proper shielding.

4. The output stage consists of class AB complementary output drivers, capable of driving a low resistance load. The output voltage swing is limited by the drain to source on-resistance of the output transistors as determined by the bias circuitry, and the value of the load resistor. When connected in the voltage follower configuration, the oscillation resistant feature, combined with the rail to rail input and output feature, makes an effective analog signal buffer for medium to high source impedance sensors, transducers, and other circuit networks.
5. The ALD2706A/ALD2706B/ALD2706 operational amplifier has been designed to provide full static discharge protection. Internally, the design has been carefully implemented to minimize latch up. However, care must be exercised when handling the device to avoid strong static fields that may degrade a diode junction, causing increased input leakage currents. In using the operational amplifier, the user is advised to power up the circuit before, or simultaneously with, any input voltages applied and to limit input voltages to not exceed 0.3V of the power supply voltage levels.
6. The ALD2706A/ALD2706B/ALD2706, with its micropower operation, offers numerous benefits in reduced power supply requirements, less noise coupling and current spikes, less thermally induced drift, better overall reliability due to lower self heating, and lower input bias current. It requires practically no warm up time as the chip junction heats up to only 0.1°C above ambient temperature under most operating conditions.

TYPICAL PERFORMANCE CHARACTERISTICS

SUPPLY CURRENT AS A FUNCTION OF SUPPLY VOLTAGE

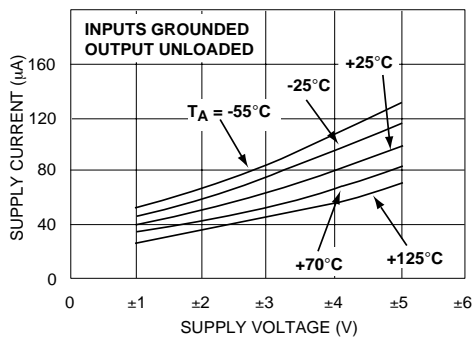

COMMON MODE INPUT VOLTAGE RANGE AS A FUNCTION OF SUPPLY VOLTAGE

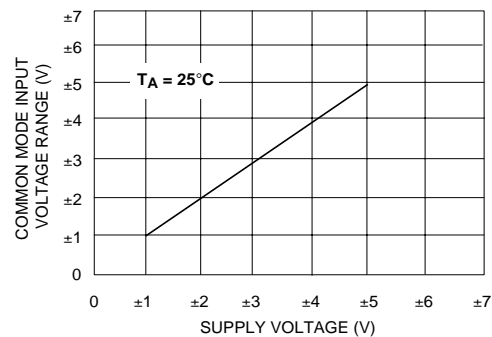

OPEN LOOP VOLTAGE GAIN AS A FUNCTION OF LOAD RESISTANCE

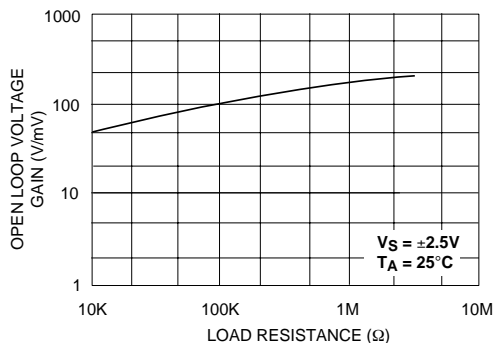

INPUT BIAS CURRENT AS A FUNCTION OF AMBIENT TEMPERATURE

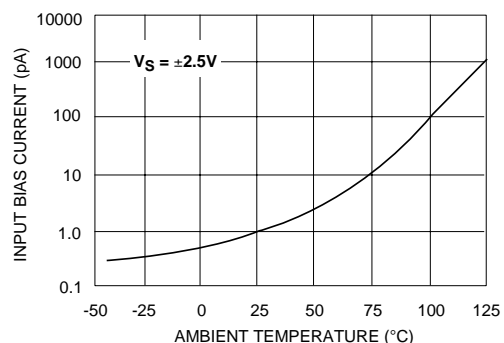

TYPICAL PERFORMANCE CHARACTERISTICS (cont'd)

OPEN LOOP VOLTAGE GAIN AS A FUNCTION OF SUPPLY VOLTAGE AND TEMPERATURE

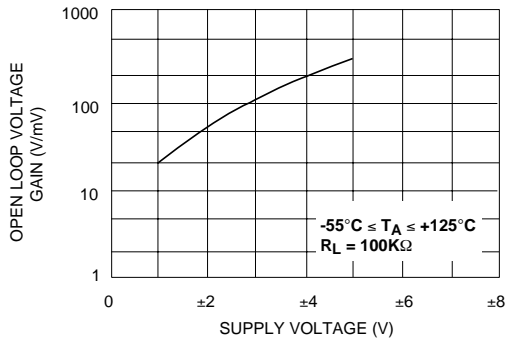

OUTPUT VOLTAGE SWING AS A FUNCTION OF SUPPLY VOLTAGE

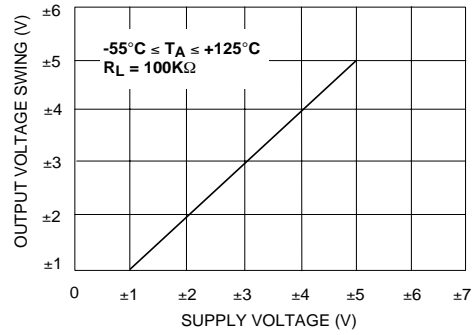

INPUT OFFSET VOLTAGE AS A FUNCTION OF AMBIENT TEMPERATURE REPRESENTATIVE UNITS

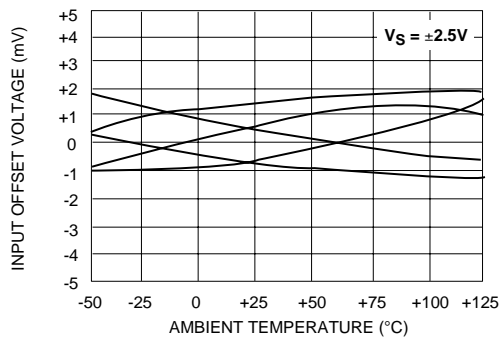

OPEN LOOP VOLTAGE GAIN AS A FUNCTION OF FREQUENCY

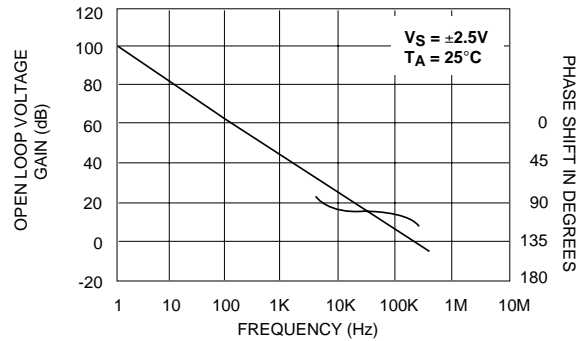

INPUT OFFSET VOLTAGE AS A FUNCTION OF COMMON MODE INPUT VOLTAGE

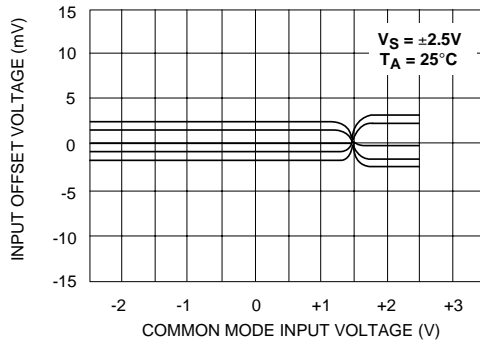

LARGE - SIGNAL TRANSIENT RESPONSE

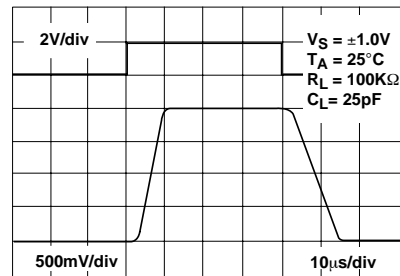

LARGE - SIGNAL TRANSIENT RESPONSE

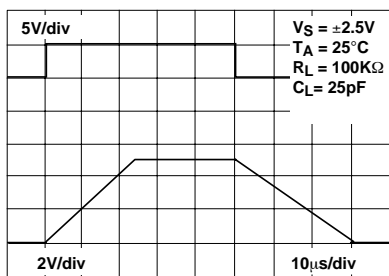

SMALL - SIGNAL TRANSIENT RESPONSE

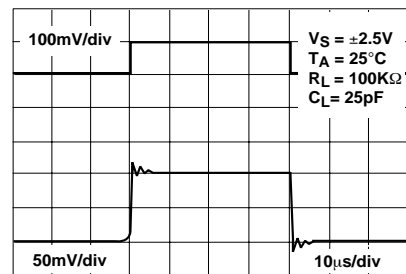

TYPICAL APPLICATIONS

RAIL-TO-RAIL VOLTAGE FOLLOWER/BUFFER

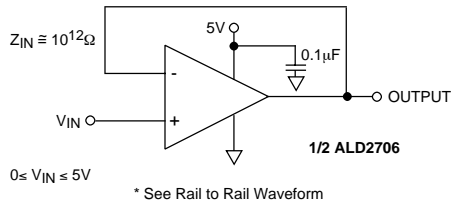

RAIL-TO-RAIL WAVEFORM

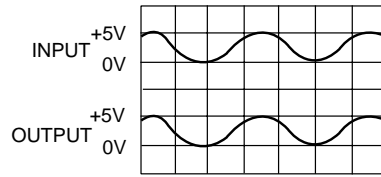

Performance waveforms.

Upper trace is the output of a Wien Bridge Oscillator. Lower trace is the output of Rail-to-Rail voltage follower.

HIGH INPUT IMPEDANCE RAIL-TO-RAIL PRECISION DC SUMMING AMPLIFIER

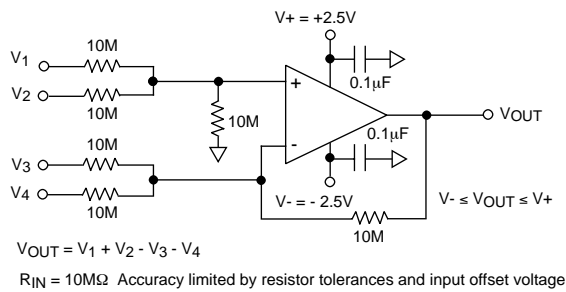

RAIL-TO-RAIL WINDOW COMPARATOR

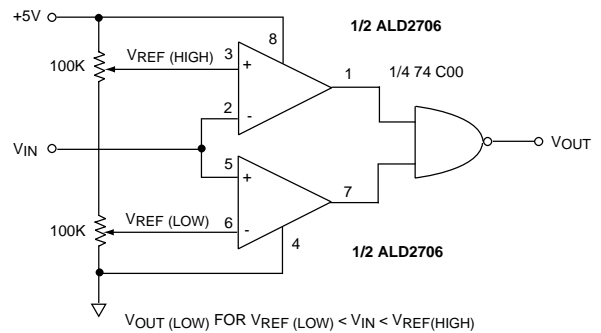
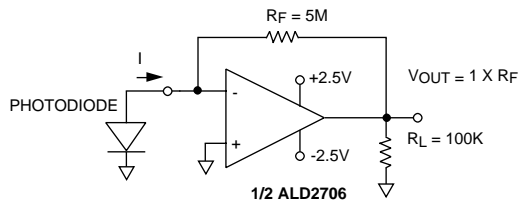
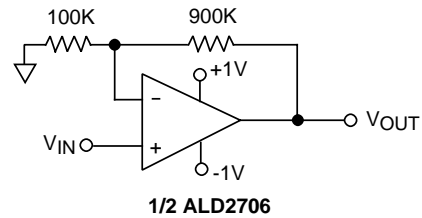

PHOTO DETECTOR CURRENT TO VOLTAGE CONVERTER



HIGH IMPEDANCE NON-INVERTING AMPLIFIER



LOW VOLTAGE INSTRUMENTATION AMPLIFIER

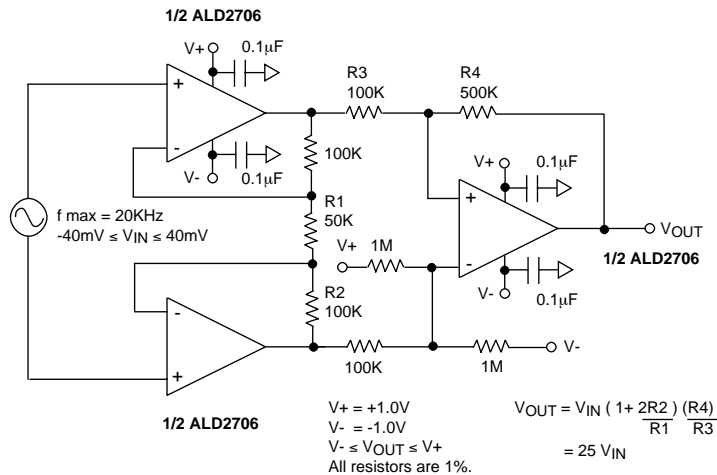

SOIC-8 PACKAGE DRAWING

8 Pin Plastic SOIC Package

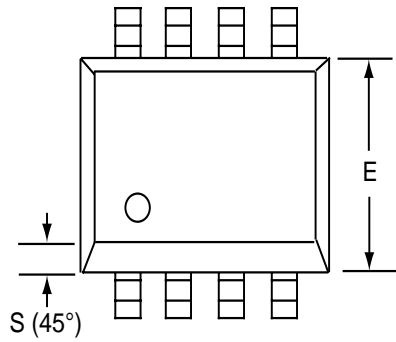

Dim	Millimeters		Inches	
	Min	Max	Min	Max
A	1.35	1.75	0.053	0.069
A ₁	0.10	0.25	0.004	0.010
b	0.35	0.45	0.014	0.018
C	0.18	0.25	0.007	0.010
D-8	4.69	5.00	0.185	0.196
E	3.50	4.05	0.140	0.160
e	1.27 BSC		0.050 BSC	
H	5.70	6.30	0.224	0.248
L	0.60	0.937	0.024	0.037
ø	0°	8°	0°	8°
S	0.25	0.50	0.010	0.020

PDIP-8 PACKAGE DRAWING

8 Pin Plastic DIP Package

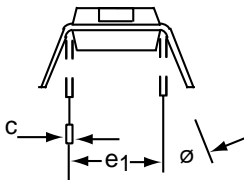
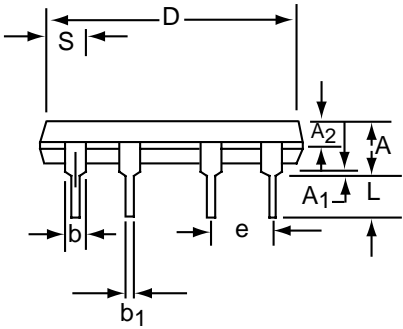

Dim	Millimeters		Inches	
	Min	Max	Min	Max
A	3.81	5.08	0.105	0.200
A ₁	0.38	1.27	0.015	0.050
A ₂	1.27	2.03	0.050	0.080
b	0.89	1.65	0.035	0.065
b ₁	0.38	0.51	0.015	0.020
c	0.20	0.30	0.008	0.012
D-8	9.40	11.68	0.370	0.460
E	5.59	7.11	0.220	0.280
E ₁	7.62	8.26	0.300	0.325
e	2.29	2.79	0.090	0.110
e ₁	7.37	7.87	0.290	0.310
L	2.79	3.81	0.110	0.150
S-8	1.02	2.03	0.040	0.080
∅	0°	15°	0°	15°

CERDIP-8 PACKAGE DRAWING

8 Pin CERDIP Package

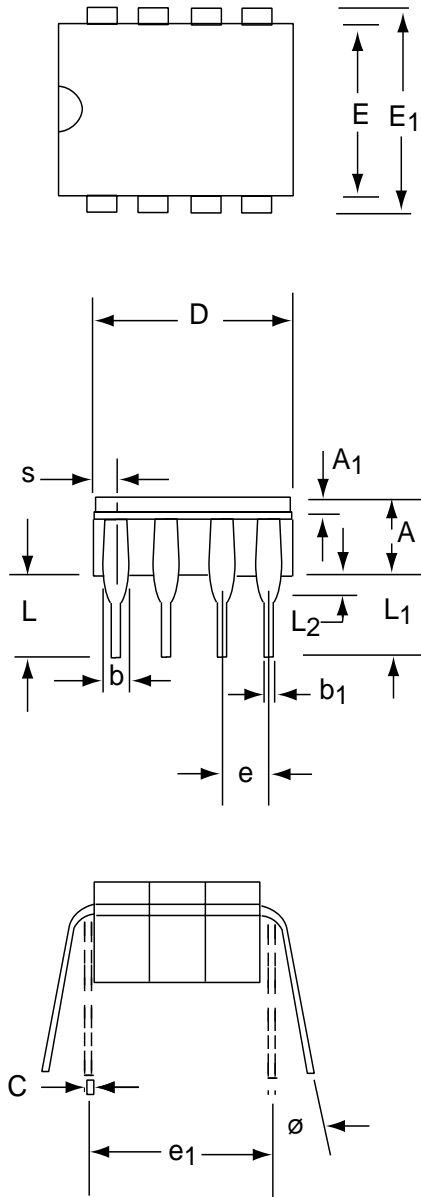

Dim	Millimeters		Inches	
	Min	Max	Min	Max
A	3.55	5.08	0.140	0.200
A₁	1.27	2.16	0.050	0.085
b	0.97	1.65	0.038	0.065
b₁	0.36	0.58	0.014	0.023
C	0.20	0.38	0.008	0.015
D-8	--	10.29	--	0.405
E	5.59	7.87	0.220	0.310
E₁	7.73	8.26	0.290	0.325
e	2.54 BSC		0.100 BSC	
e₁	7.62 BSC		0.300 BSC	
L	3.81	5.08	0.150	0.200
L₁	3.18	--	0.125	--
L₂	0.38	1.78	0.015	0.070
S	--	2.49	--	0.098
∅	0°	15°	0°	15°