

**General Description**

The AOTF10N90 has been fabricated using an advanced high voltage MOSFET process that is designed to deliver high levels of performance and robustness in popular AC-DC applications. By providing low  $R_{DS(on)}$ ,  $C_{iss}$  and  $C_{rss}$  along with guaranteed avalanche capability this part can be adopted quickly into new and existing offline power supply designs.

For Halogen Free add "L" suffix to part number:  
 AOTF10N90L

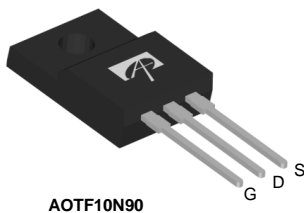
**Product Summary**

$V_{DS}$	1000V@150°C
$I_D$ (at $V_{GS}=10V$ )	10A
$R_{DS(ON)}$ (at $V_{GS}=10V$ )	< 0.98Ω

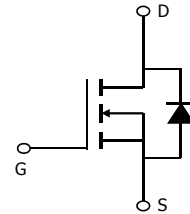
100% UIS Tested  
 100%  $R_g$  Tested



Top View  
 TO-220F



AOTF10N90


**Absolute Maximum Ratings  $T_A=25^\circ\text{C}$  unless otherwise noted**

Parameter	Symbol	AOTF10N90	Units
Drain-Source Voltage	$V_{DS}$	900	V
Gate-Source Voltage	$V_{GS}$	±30	V
Continuous Drain Current	$I_D$	$T_C=25^\circ\text{C}$	10*
		$T_C=100^\circ\text{C}$	7*
Pulsed Drain Current <sup>C</sup>	$I_{DM}$	38	A
Avalanche Current <sup>C</sup>	$I_{AR}$	3.7	A
Repetitive avalanche energy <sup>C</sup>	$E_{AR}$	205	mJ
Single pulsed avalanche energy <sup>G</sup>	$E_{AS}$	410	mJ
Peak diode recovery dv/dt	dv/dt	5	V/ns
Power Dissipation <sup>B</sup>	$P_D$	$T_C=25^\circ\text{C}$	50
		Derate above 25°C	0.4
Junction and Storage Temperature Range	$T_J, T_{STG}$	-55 to 150	°C
Maximum lead temperature for soldering purpose, 1/8" from case for 5 seconds	$T_L$	300	°C

**Thermal Characteristics**

Parameter	Symbol	AOTF10N90	Units
Maximum Junction-to-Ambient <sup>A,D</sup>	$R_{\theta JA}$	65	°C/W
Maximum Junction-to-Case	$R_{\theta JC}$	2.5	°C/W

\* Drain current limited by maximum junction temperature.

**Electrical Characteristics (T<sub>J</sub>=25°C unless otherwise noted)**

Symbol	Parameter	Conditions	Min	Typ	Max	Units	
<b>STATIC PARAMETERS</b>							
BV <sub>DSS</sub>	Drain-Source Breakdown Voltage	I <sub>D</sub> =250μA, V <sub>GS</sub> =0V, T <sub>J</sub> =25°C	900			V	
		I <sub>D</sub> =250μA, V <sub>GS</sub> =0V, T <sub>J</sub> =150°C		1000			
BV <sub>DSS</sub> /ΔT <sub>J</sub>	Zero Gate Voltage Drain Current	I <sub>D</sub> =250μA, V <sub>GS</sub> =0V		0.9		V/°C	
I <sub>DSS</sub>	Zero Gate Voltage Drain Current	V <sub>DS</sub> =900V, V <sub>GS</sub> =0V			1	μA	
		V <sub>DS</sub> =720V, T <sub>J</sub> =125°C			10		
I <sub>GSS</sub>	Gate-Body leakage current	V <sub>DS</sub> =0V, V <sub>GS</sub> =±30V			±100	nA	
V <sub>GS(th)</sub>	Gate Threshold Voltage	V <sub>DS</sub> =5V, I <sub>D</sub> =250μA	3.4	4	4.5	V	
R <sub>DS(ON)</sub>	Static Drain-Source On-Resistance	V <sub>GS</sub> =10V, I <sub>D</sub> =5A		0.82	0.98	Ω	
g <sub>FS</sub>	Forward Transconductance	V <sub>DS</sub> =40V, I <sub>D</sub> =5A		17		S	
V <sub>SD</sub>	Diode Forward Voltage	I <sub>S</sub> =1A, V <sub>GS</sub> =0V		0.7	1	V	
I <sub>S</sub>	Maximum Body-Diode Continuous Current				10	A	
I <sub>SM</sub>	Maximum Body-Diode Pulsed Current				38	A	
<b>DYNAMIC PARAMETERS</b>							
C <sub>iss</sub>	Input Capacitance	V <sub>GS</sub> =0V, V <sub>DS</sub> =25V, f=1MHz	2100	2630	3160	pF	
C <sub>oss</sub>	Output Capacitance		130	190	250	pF	
C <sub>rss</sub>	Reverse Transfer Capacitance		10	18	26	pF	
R <sub>g</sub>	Gate resistance	V <sub>GS</sub> =0V, V <sub>DS</sub> =0V, f=1MHz	1.5	3.4	5.2	Ω	
<b>SWITCHING PARAMETERS</b>							
Q <sub>g</sub>	Total Gate Charge	V <sub>GS</sub> =10V, V <sub>DS</sub> =720V, I <sub>D</sub> =10A	45	60	75	nC	
Q <sub>gs</sub>	Gate Source Charge				13		nC
Q <sub>gd</sub>	Gate Drain Charge				27		nC
t <sub>D(on)</sub>	Turn-On DelayTime	V <sub>GS</sub> =10V, V <sub>DS</sub> =450V, I <sub>D</sub> =10A, R <sub>G</sub> =25Ω			64	ns	
t <sub>r</sub>	Turn-On Rise Time				105		ns
t <sub>D(off)</sub>	Turn-Off DelayTime				155		ns
t <sub>f</sub>	Turn-Off Fall Time				84		ns
t <sub>rr</sub>	Body Diode Reverse Recovery Time	I <sub>F</sub> =10A, di/dt=100A/μs, V <sub>DS</sub> =100V	460	575	700	ns	
Q <sub>rr</sub>	Body Diode Reverse Recovery Charge	I <sub>F</sub> =10A, di/dt=100A/μs, V <sub>DS</sub> =100V	7.0	9.9	12.0	μC	

A. The value of R<sub>θJA</sub> is measured with the device in a still air environment with T<sub>A</sub>=25° C.

B. The power dissipation P<sub>D</sub> is based on T<sub>J(MAX)</sub>=150° C, using junction-to-case thermal resistance, and is more useful in setting the upper dissipation limit for cases where additional heatsinking is used.

C. Repetitive rating, pulse width limited by junction temperature T<sub>J(MAX)</sub>=150° C, Ratings are based on low frequency and duty cycles to keep initial T<sub>J</sub>=25° C.

D. The R<sub>θJA</sub> is the sum of the thermal impedance from junction to case R<sub>θJC</sub> and case to ambient.

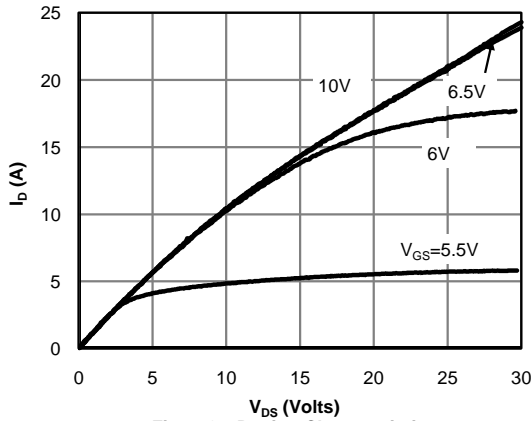
E. The static characteristics in Figures 1 to 6 are obtained using <300 μs pulses, duty cycle 0.5% max.

F. These curves are based on the junction-to-case thermal impedance which is measured with the device mounted to a large heatsink, assuming a maximum junction temperature of T<sub>J(MAX)</sub>=150° C. The SOA curve provides a single pulse rating.

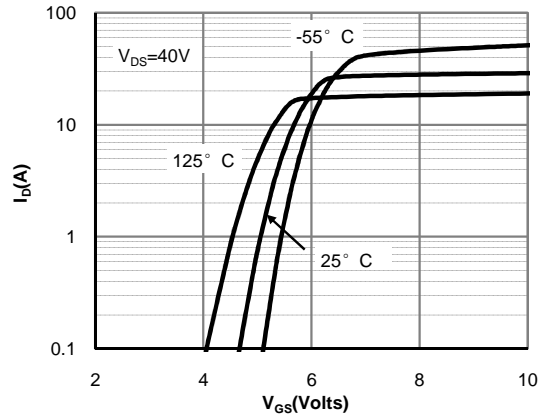
G. L=60mH, I<sub>AS</sub>=3.7A, V<sub>DD</sub>=150V, R<sub>G</sub>=25Ω, Starting T<sub>J</sub>=25° C

THIS PRODUCT HAS BEEN DESIGNED AND QUALIFIED FOR THE CONSUMER MARKET. APPLICATIONS OR USES AS CRITICAL COMPONENTS IN LIFE SUPPORT DEVICES OR SYSTEMS ARE NOT AUTHORIZED. AOS DOES NOT ASSUME ANY LIABILITY ARISING OUT OF SUCH APPLICATIONS OR USES OF ITS PRODUCTS. AOS RESERVES THE RIGHT TO IMPROVE PRODUCT DESIGN, FUNCTIONS AND RELIABILITY WITHOUT NOTICE.

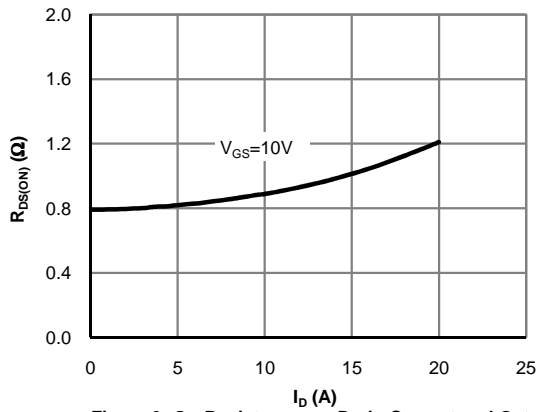
**TYPICAL ELECTRICAL AND THERMAL CHARACTERISTICS**



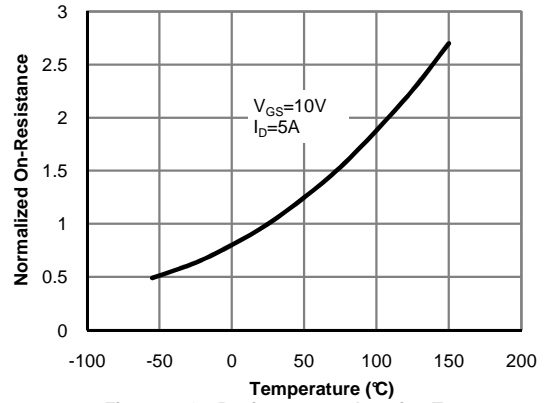
**Figure 1: On-Region Characteristics**



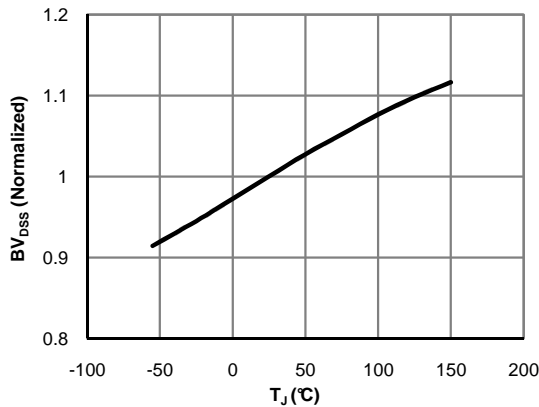
**Figure 2: Transfer Characteristics**



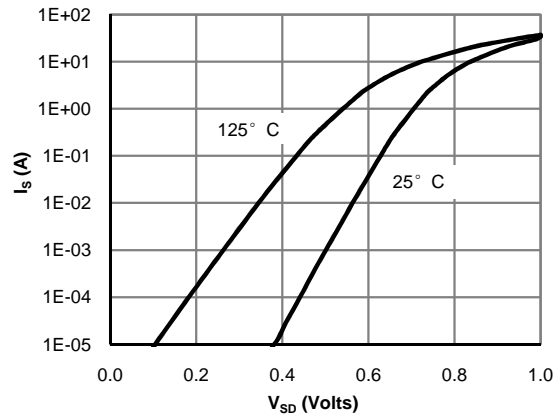
**Figure 3: On-Resistance vs. Drain Current and Gate Voltage**



**Figure 4: On-Resistance vs. Junction Temperature**

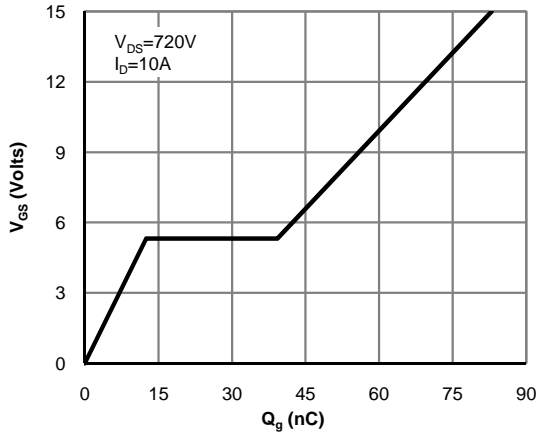


**Figure 5: Break Down vs. Junction Temperature**

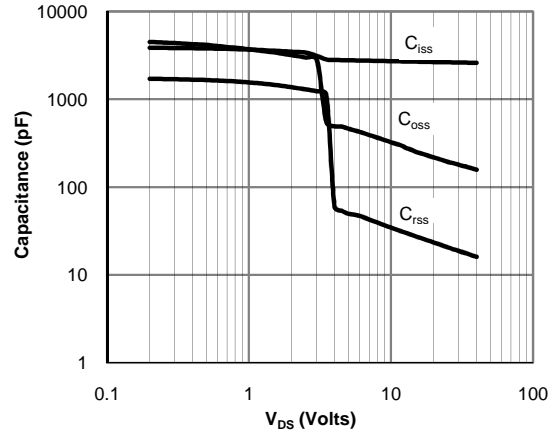


**Figure 6: Body-Diode Characteristics (Note E)**

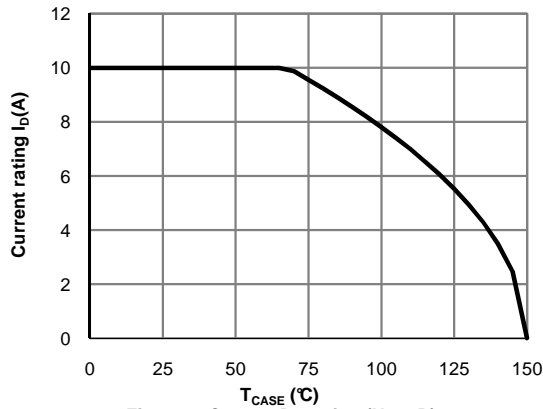
**TYPICAL ELECTRICAL AND THERMAL CHARACTERISTICS**



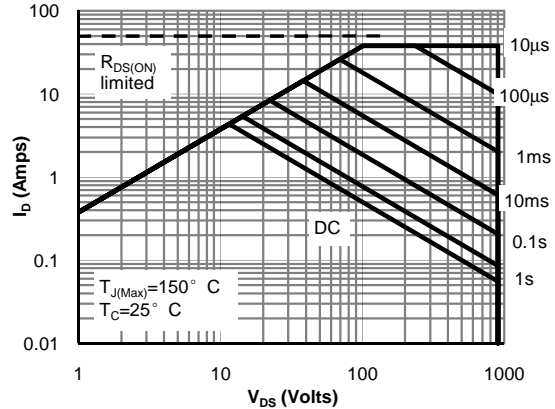
**Figure 7: Gate-Charge Characteristics**



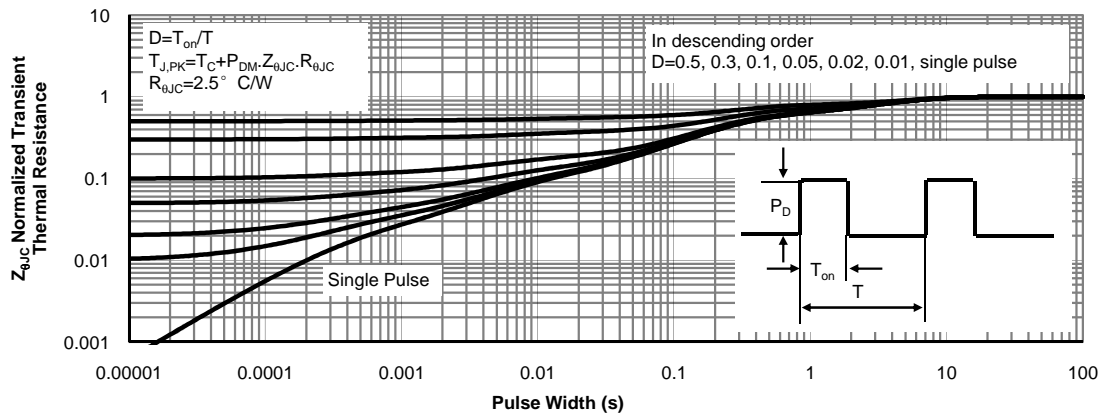
**Figure 8: Capacitance Characteristics**



**Figure 9: Current De-rating (Note B)**

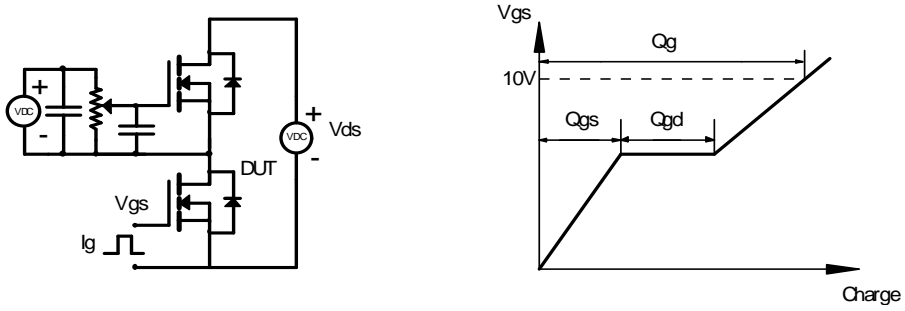


**Figure 10: Maximum Forward Biased Safe Operating Area for AOTF10N90 (Note F)**

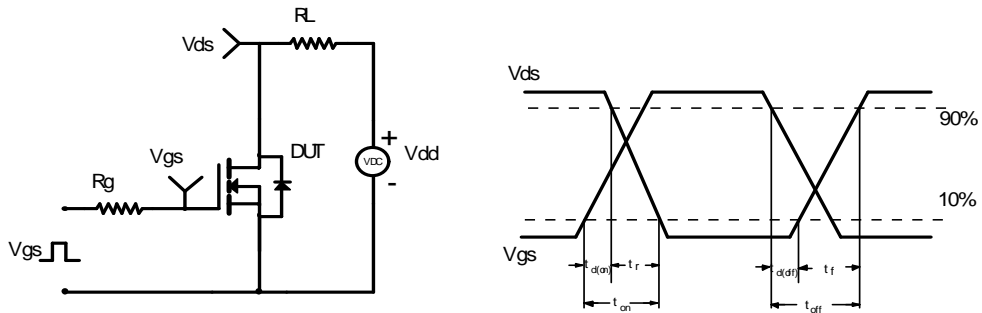


**Figure 11: Normalized Maximum Transient Thermal Impedance for AOTF10N90 (Note F)**

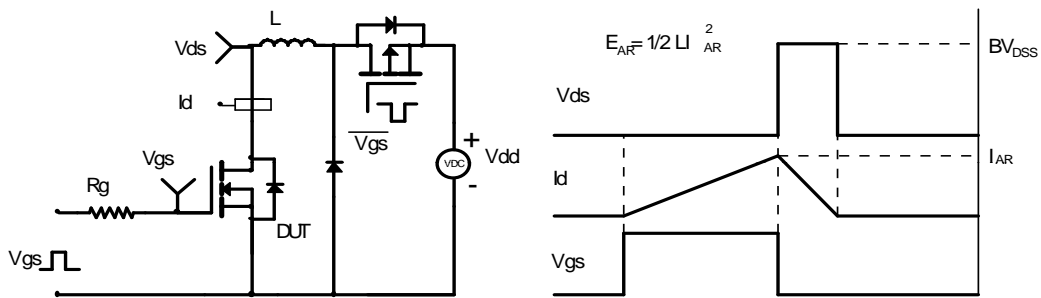
Gate Charge Test Circuit & Waveform



Resistive Switching Test Circuit & Waveforms



Unclamped Inductive Switching (UIS) Test Circuit & Waveforms



Diode Recovery Test Circuit & Waveforms

