



### FEATURES

- ◆ Efficiency up to 80%
- ◆ Twin Independent Output
- ◆ Small Footprint
- ◆ SMD Package Styles
- ◆ Industry Standard Pinout
- ◆ No Heatsink Required
- ◆ 1kVDC Isolation
- ◆ High Power Density
- ◆ Temperature Range: -40°C ~ +85°C
- ◆ No External Component Required
- ◆ Internal SMD construction
- ◆ RoHS Compliance

### MODEL SELECTION

**D<sup>①</sup>05<sup>②</sup>05<sup>③</sup>05<sup>④</sup>N<sup>⑤</sup>X<sup>⑥</sup>T<sup>⑦</sup>-1W<sup>⑧</sup>**

- ① Product Series
- ② Input Voltage
- ③ The 1st Output Voltage
- ④ The 2nd Output Voltage
- ⑤ No Pin
- ⑥ Fixed Input
- ⑦ SMD Package
- ⑧ Rated Power

### APPLICATIONS

The D\_NXT-1W series are specially designed for applications where a group of polar power supplies are isolated from the input power supply in a distributed power supply system on a circuit board. These products apply to:

- 1) Where the voltage of the input power supply is fixed (voltage variation  $\leq \pm 10\%$ );
- 2) Where isolation is necessary between input and output (isolation voltage  $\leq \pm 1000\text{VDC}$ );
- 3) Where the regulation of the output voltage and the output ripple and noise are not demanding.  
Such as: purely digital circuits, ordinary low frequency analog circuits and IGBT power device driven circuits, etc.

### PRODUCT PROGRAM

Part Number	Input		Output			Efficiency (%Typ)
	Voltage(VDC)		Voltage (VDC)	Current(MA)		
	Nominal	Range		Max	Min.	
D050505NXT-1W	5	4.5-5.5	5/5	100/100	10/10	70
D050909NXT-1W	5	4.5-5.5	9/9	56/56	6/6	75
D051212NXT-1W	5	4.5-5.5	12/12	42/42	4/4	79
D051515NXT-1W	5	4.5-5.5	15/15	33/33	3/3	80
D120505NXT-1W	12	10.8-13.2	5/5	100/100	10/10	72
D120909NXT-1W	12	10.8-13.2	9/9	56/56	6/6	75
D121212NXT-1W	12	10.8-13.2	12/12	42/42	4/4	78
D121515NXT-1W	12	10.8-13.2	15/15	33/33	3/3	80

Note: The D\_NXT-W2/W5 series also are available in our company.

### COMMON SPECIFICATIONS

Item	Test Conditions	Min.	Typ.	Max.	Unit
Storage humidity				95	%
Operating temperature		-40		85	°C
Storage temperature		-55		125	
Temp. rise at full load				25	
Lead temperature	1.5mm from case for 10 seconds		15	300	
Short circuit protection*				1	S
Cooling		Free air convection			
package material		Epoxy Resin (UL94-V0)			
MTBF		3500			K
Weight			2.1		g

\*Supply voltage must be discontinued at the end of short circuit duration.

### ISOLATION SPECIFICATIONS

Item	Test Conditions	Min.	Typ.	Max.	Unit
Isolation voltage(Vin/Vout)	Tested for 1 minute and 1mA max	1000			VDC
Isolation voltage(Vo1/Vo2)	Tested for 1 minute and 1mA max	1000			VDC
Isolation resistance(Vin/Vout)	Test at 500VDC	1000			MΩ
Isolation resistance(Vo1/Vo2)	Test at 500VDC	1000			MΩ
Isolation capacitance(Vin/Vout)			60		pF
Isolation capacitance(Vo1/Vo2)			60		pF



### OUTPUT SPECIFICATIONS

Item	Test Conditions	Min.	Typ.	Max.	Units
Output power		0.1		1	W
Line regulation	For Vin change of ±1%			±1.2	%
Load regulation	10% to 100% load(5V output)		12.8	15	%
Load regulation	10% to 100% load(9V output)		8.3	10	%
Load regulation	10% to 100% load(12V output)		6.8	10	%
Load regulation	10% to 100% load(15V output)		6.0	10	%
Output voltage accuracy	See tolerance envelope graph				
Temperature drift	100% full load			±0.03	%/°C
Ripple & Noise*	20MHz Bandwidth		50	75	mVp-p
Switching frequency	Full load, nominal input		100		KHz

\*Test ripple and noise by "Parallel cable" method. See detailed operation instructions at Testing of Power Converter section, application notes.

### APPLICATION NOTE

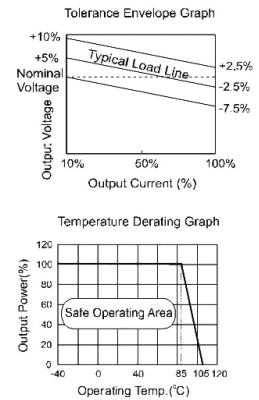

### RECOMMENDED REFLOW SOLDERING PROFILE

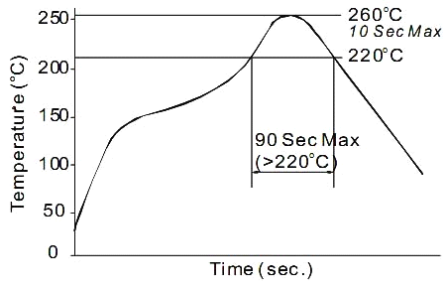

Remark: The curve applies only to the hot air reflow soldering

### RECOMMENDED CIRCUIT

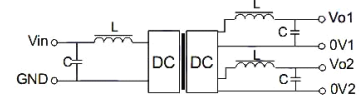

(Figure 1)

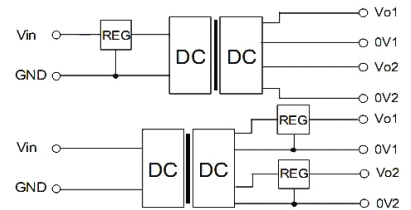

### EXTERNAL CAPACITOR TABLE (TABLE 1)

Vin (VDC)	Cin (μF)	Vout (VDC)	Cout (μF)
5	4.7	5	4.7
12	2.2	9	2.2
-	-	12	1
-	-	15	0.47

It's not recommended to connect any external capacitor in the application field with less than 0.5 watt output.

### TYPICAL CHARACTERISTICS

#### 1) Requirement On Output Load

To ensure this module can operate efficiently and reliably, a minimum load is specified for this kind of DC/DC converter in addition to a maximum load (namely full load). During operation, make sure the specified range of input voltage is not exceeded, the minimum output load could not be less than 10% of the full load. If the actual output power is very small, please connect a resistor with proper resistance at the output end in parallel to increase the load, or use our company products with a lower rated output power (D-NXT-W2/W5).

#### 2) Recommended testing circuit

If you want to further decrease the input/output ripple, an "LC" filtering network may be connected to the input and output ends of the DC/DC converter, see (Figure1).

It should also be noted that the inductance and the frequency of the "LC" Filtering network should be staggered with the DC/DC frequency to avoid mutual interference. However, the capacitance of the output filter capacitor must be proper. If the capacitance is too big, a startup problem might arise. For every channel of output, provided the safe and reliable operation is ensured, the greatest capacitance of its filter capacitor sees (Table 1).

#### 3) Output Voltage Regulation and Over-voltage Protection Circuit

The simplest device for output voltage regulation, over-voltage and over-current protection is a linear voltage regulator with overheat protection that is connected to the input or output end in series (Figure2).

#### 4) Overload Protection

Under normal operating conditions, the output circuit of these products has no protection against overload. The simplest method is to connect a self-recovery fuse in series at the input end or add a circuit breaker to the circuit.

#### 5) Cannot use in parallel and hot swap

### OUTLINE DIMENSIONS & RECOMMENDED FOOTPRINT

#### MECHANICAL DIMENSIONS

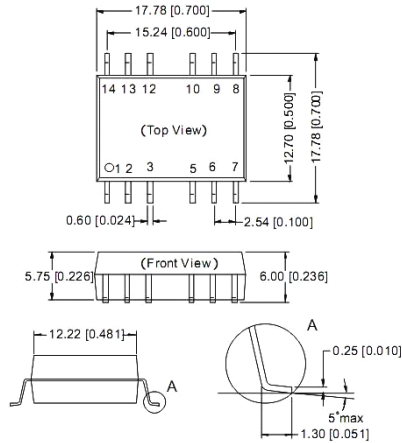

Note:  
 Unit: mm[inch]  
 Pin section tolerances:  $\pm 0.10\text{mm}$  [0.004inch]  
 General tolerances:  $\pm 0.25\text{mm}$  [0.010inch]

#### RECOMMENDED FOOTPRINT

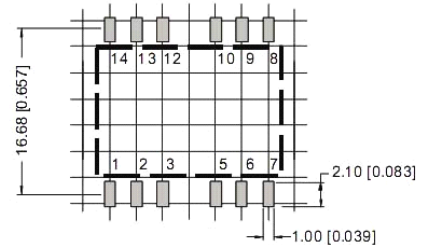

Note: grid 2.54\*2.54mm.

Pin	Function
1	GND
2	Vin
5	OV1
6	Vo1
9	Vo2
10	OV2
Others	NC

NC: No Connection

#### TUBE OUTLINE DIMENSIONS

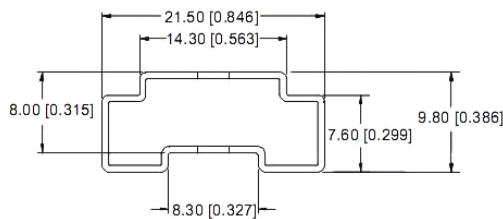

Note:  
 Unit: mm[inch]  
 General tolerances:  $\pm 0.50\text{mm}$  [ $\pm 0.020\text{inch}$ ]  
 L=530mm[20.866inch] Devices per tube quantity: 28pcs  
 L=220mm[8.661inch] Devices per tube quantity: 10pcs  
 Short tube inner package dimensions : L\*W\*H= 255\*170\*80mm  
 Short tube outer package dimensions(with six inner package boxes):  
 L\*W\*H= 375\*280\*270mm  
 Long tube inner package dimensions : L\*W\*H= 580\*200\*100mm  
 Long tube outer package dimensions(with two inner package boxes):  
 L\*W\*H= 600\*215\*220mm  
 Long tube outer package dimensions(with three inner package boxes):  
 L\*W\*H= 600\*215\*325mm

#### REEL PACKING OUTLINE DIMENSIONS

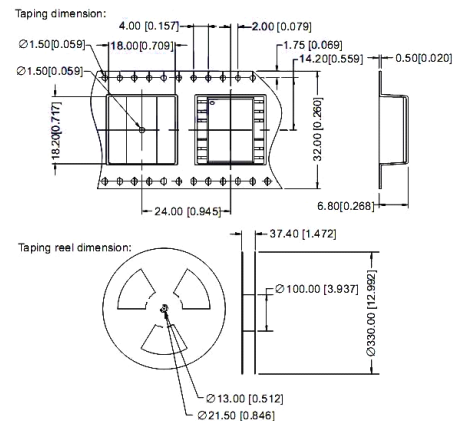

Note:  
 Unit :mm[inch]  
 General tolerances:  $\pm 0.50\text{mm}$  [0.020inch]  
 Per reel of packing quantity:400pcs  
 Inner package carton dimensions: L\*W\*H=365\*350\*105mm  
 Tube Quantity : 800pcs  
 Outer package carton dimensions: L\*W\*H=390\*360\*245mm  
 Tube Quantity:1600pcs

#### RoHS COMPLIANT INFORMATION

This series is compatible with RoHS soldering systems with a peak wave solder temperature of 300° C for 10 seconds.  
 The pin termination finish on the SIP package type is Tin Plate, Hot Dipped over Matte Tin with Nickel Preplate. The DIP types are Matte Tin over Nickel Preplate. Both types in this series are backward compatible with Sn/Pb soldering systems.

#### REACH COMPLIANT INFORMATION

This series has proven that this product does not contain harmful chemicals, it also has harmful chemical substances through the registration, inspection and approval.