

SPECIFICATION

Part No.	: FXP831.07.0100C
Product Name	: FXP.831 Freedom 2.4/5 GHz Ground Coupled Antenna
Feature	: Flexible Ultra Low Profile 45mm*7mm*0.1mm Adheres directly to inside of product plastic or glass housing Form factor and cable routing convenient for integration High Efficiency IPEX MHF Connector (U.FL compatible) 100m 1.37mm co-axial cable RoHS Compliant



1. Introduction

The FXP831 is a high efficiency, small, dual-band, dipole antenna for 2.4/4.9-6GHz band including Bluetooth and Wi-Fi. The FXP.831 has a peak gain of 2.5dBi at 2.4GHz and efficiencies of 56%, and 4.5dBi and 55% along bands 4.9GHz to 6GHz.

This Taoglas patent pending antenna is unique in the market because it is made from poly-flexible material, has a tiny form factor (45*7*.01mm) and has double-sided 3M tape for easy "peel and stick" mounting.

The cable routes conveniently directly out of the bottom of the antenna, reducing the volume the antenna takes up in the device to an absolute minimum compared to other designs. The FXP.831 is the ideal all-round antenna solution for squeezing into narrow spaces and still maintaining high performance, for example on the inside top or adjacent side applied directly to the plastic housing of LCD devices.

2. Specification

ELECTRICAL		
Frequency	2.4 ~ 2.5GHz,	4.9 ~ 5.8GHz
Peak Gain (free space)	2.5dBi	4.5dBi
Peak Gain (on plastic*)	3.0dBi	5.5dBi
Average Gain (free space)	-2.6dBi	-2.6dBi
Average Gain (on plastic)	-2.6dBi	-1.8dBi
Efficiency (free space)	56%	55%
Efficiency (on plastic)	56%	75%
VSWR	≤2.5 : 1	
Impedance	50 Ohms	
Polarization	Linear	
Radiation Pattern	Omni	
Input Power	2W max.	
MECHANICAL		
Dimensions	45mm x 7mm	
Antenna Body Material	Polymer	
Cable	Gray 100mm 1.37 co-axial	
Connector	Iplex MHF	
ENVIRONMENTAL		
Temperature Range	-40°C to 85°C	
Humidity	Non-condensing 65°C 95% RH	

3. Electrical Characteristic

3.1 S11

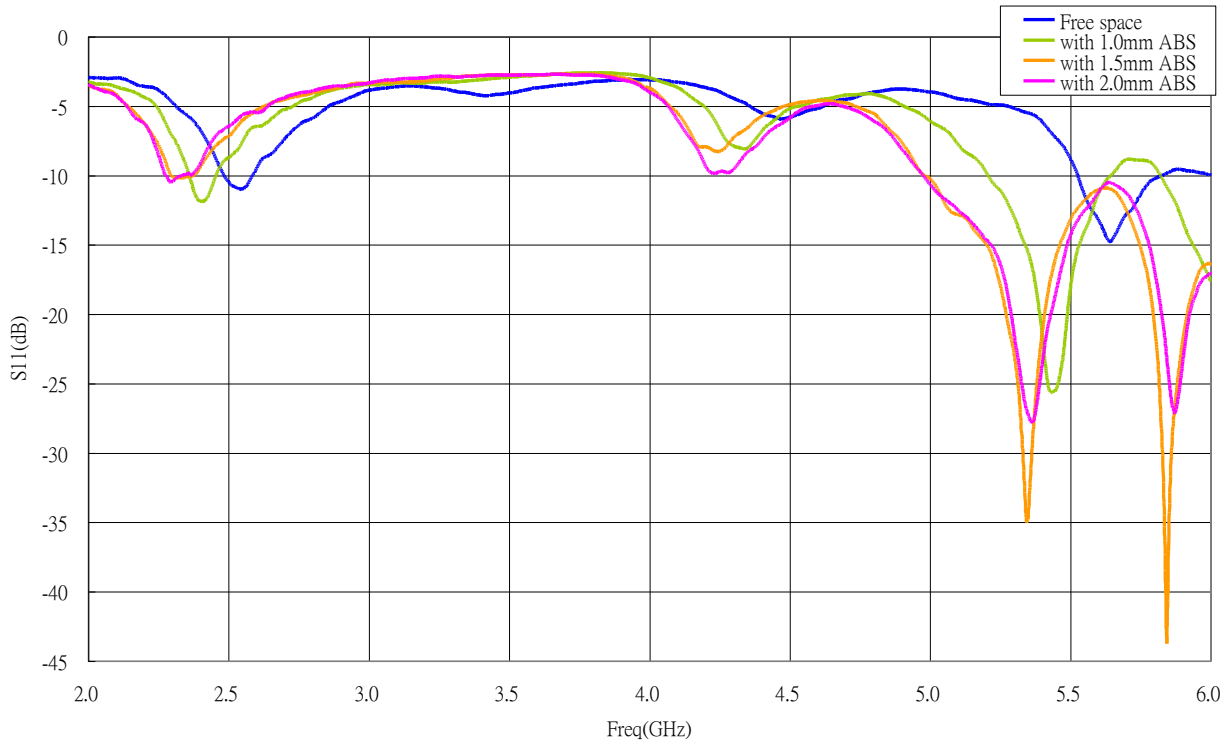

3.2 Test Setup

A ETS AMS-8500 test chamber is used for the free space radiation testing for FXP831.07.0100A. The measurement is taken with the antenna properly mounted in the designated device

Device tested in AMS-8500 Rectangular test chamber.

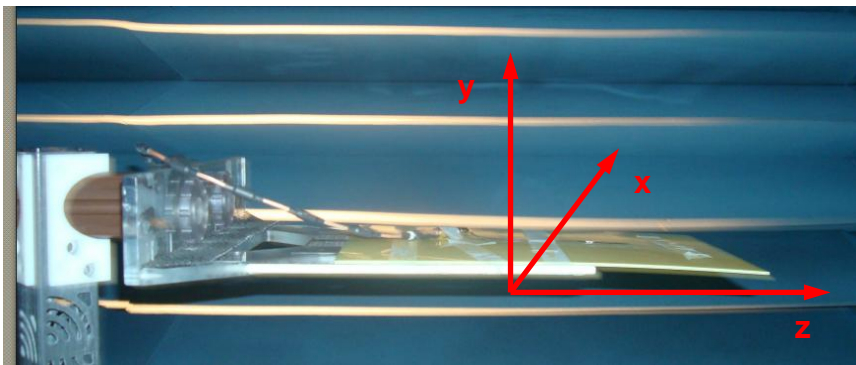

FXP831 on Baxter device to indicate the testing coordinate

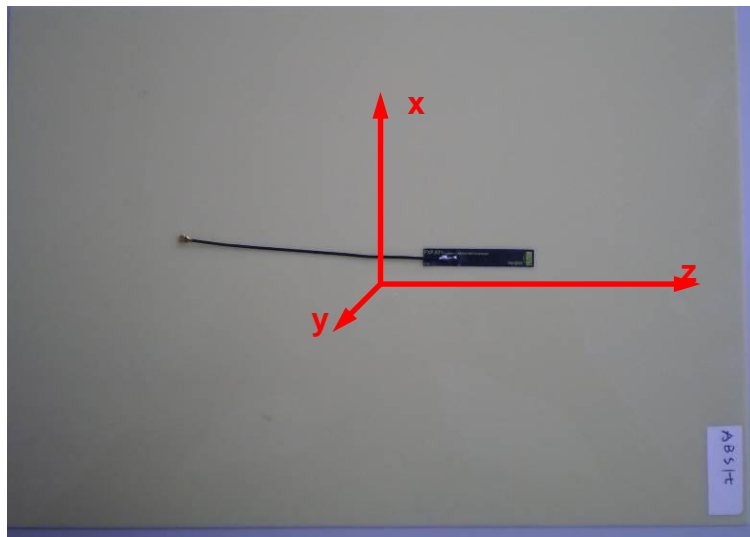

FXP831 on Baxter device to indicate the testing coordinate

3.3 Radiation Pattern

3.3.1 XZ plane (at 2400MHz)

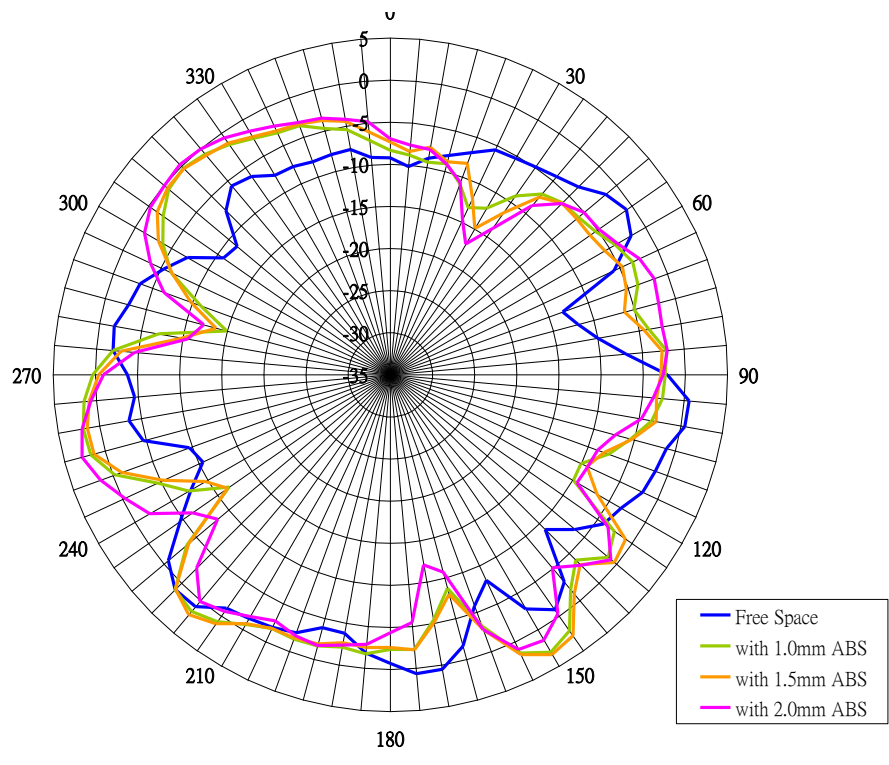

3.3.2 XZ plane (at 2500MHz)

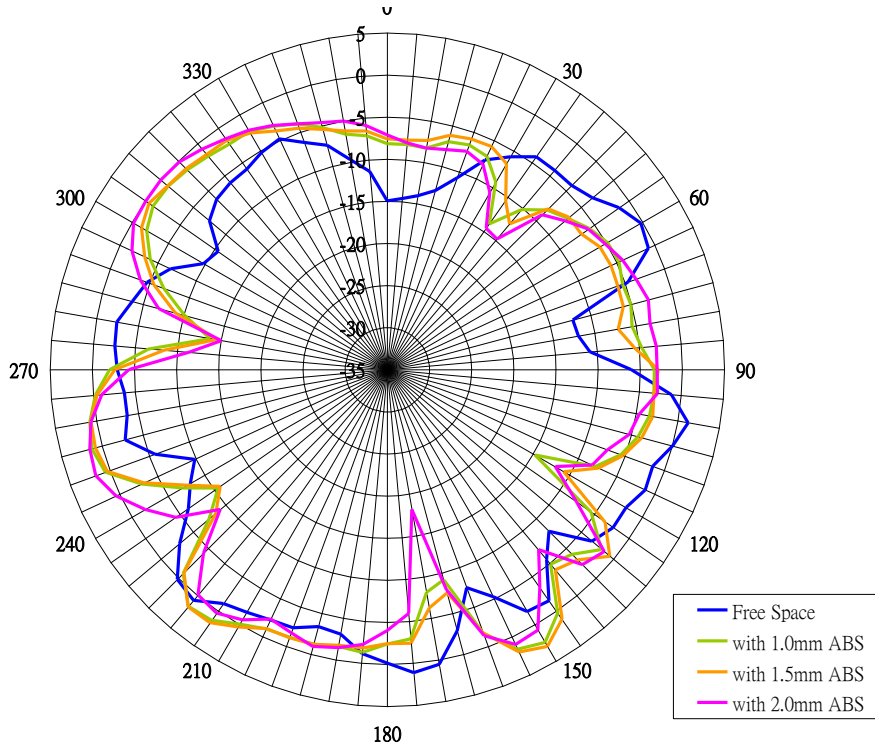

3.3.3 XZ plane (at 5000MHz)

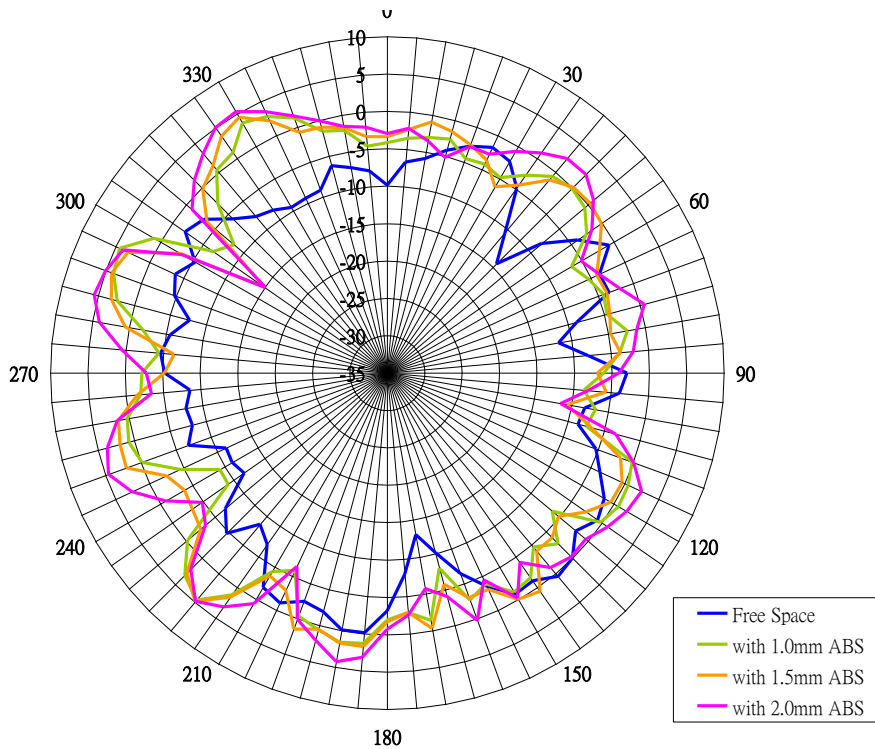

3.3.4 XZ plane (at 5500MHz)

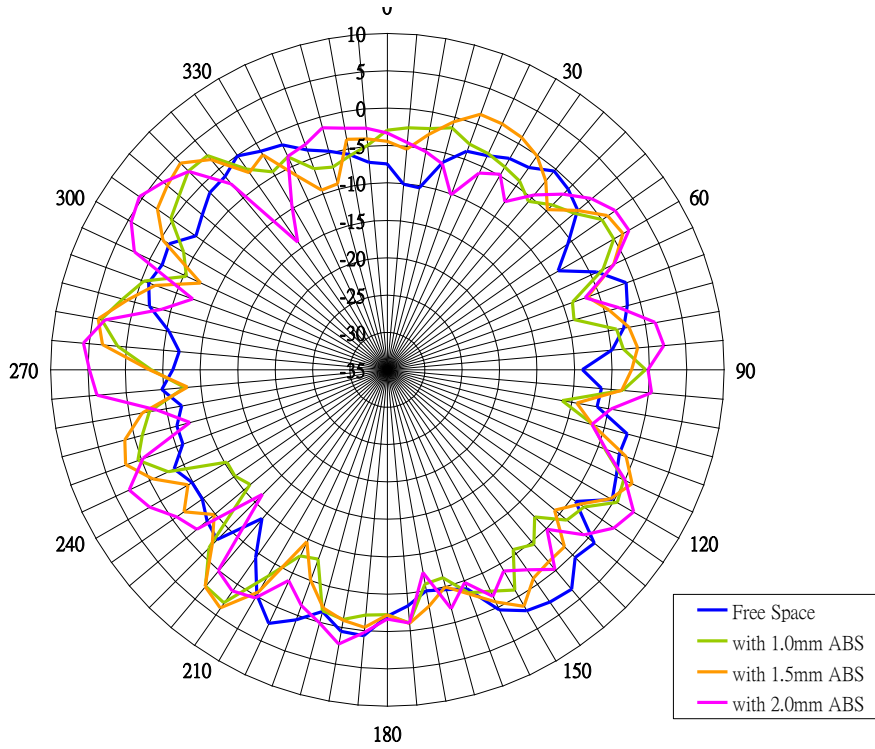

3.3.5 XZ plane (at 6000MHz)

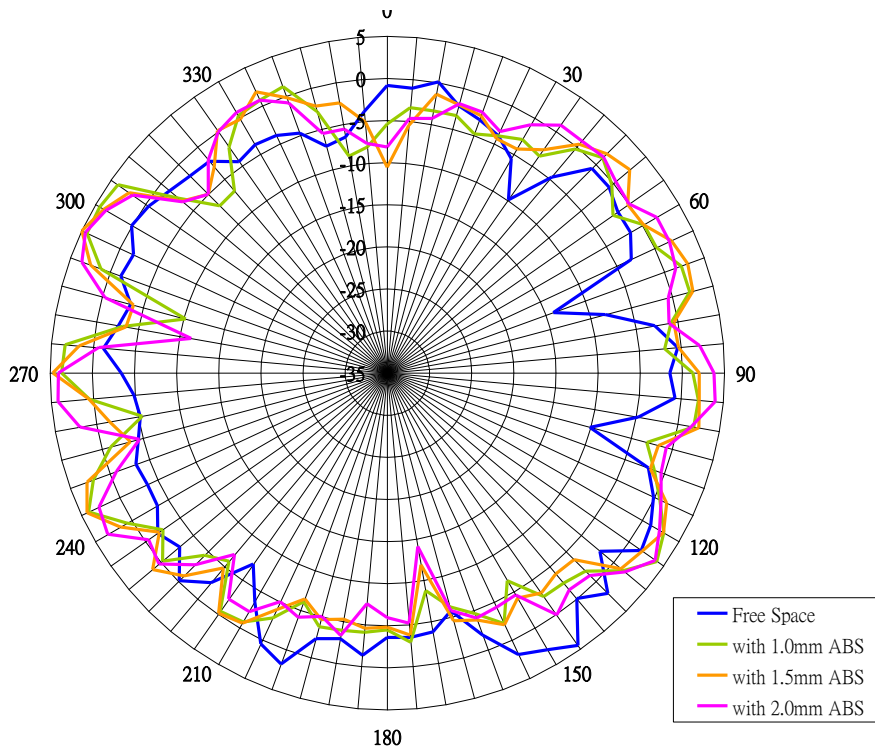

3.3.6 YZ plane (at 2400MHz)

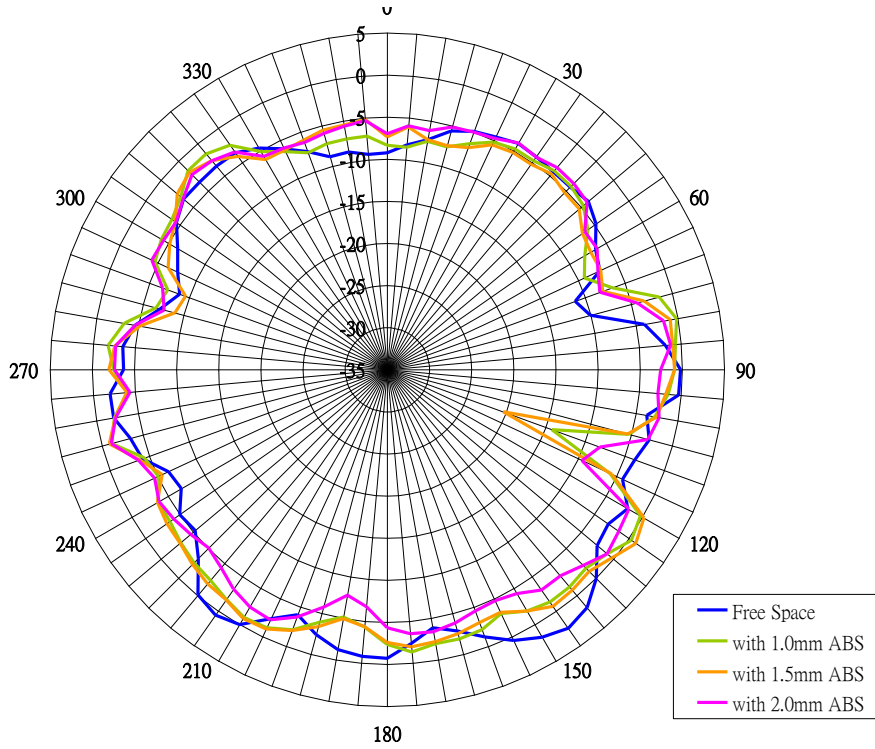

3.3.7 YZ plane (at 2500MHz)

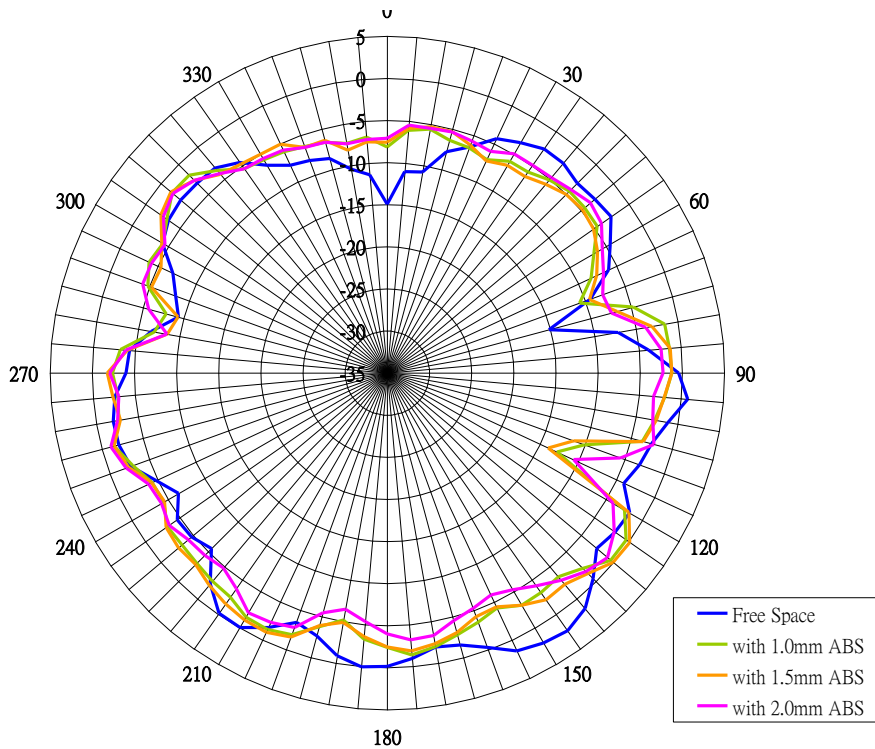

3.3.8 YZ plane (at 5000MHz)

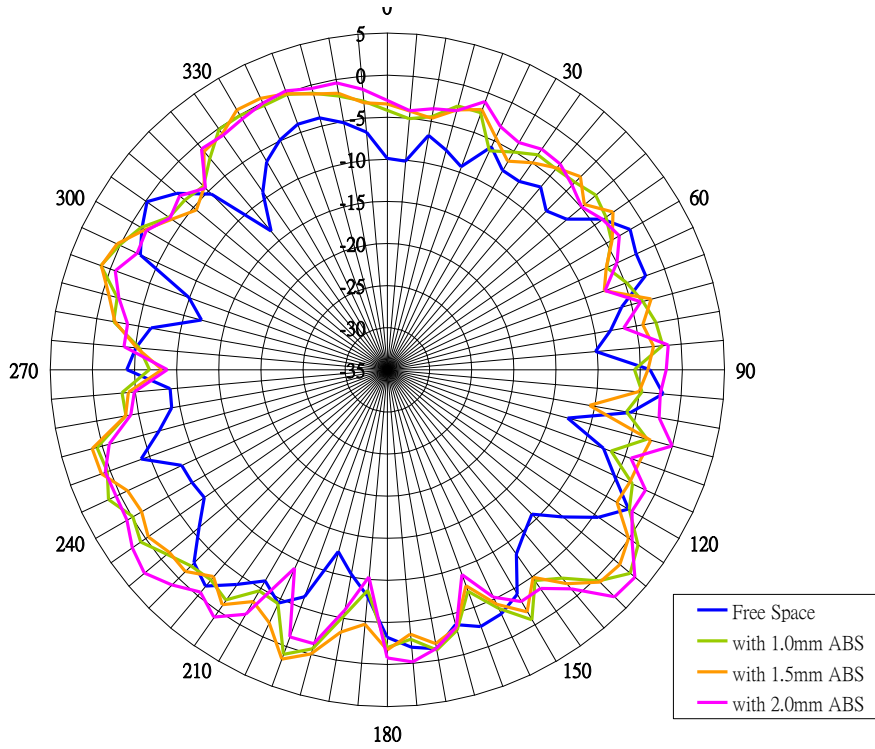

3.3.9 YZ plane (at 5500MHz)

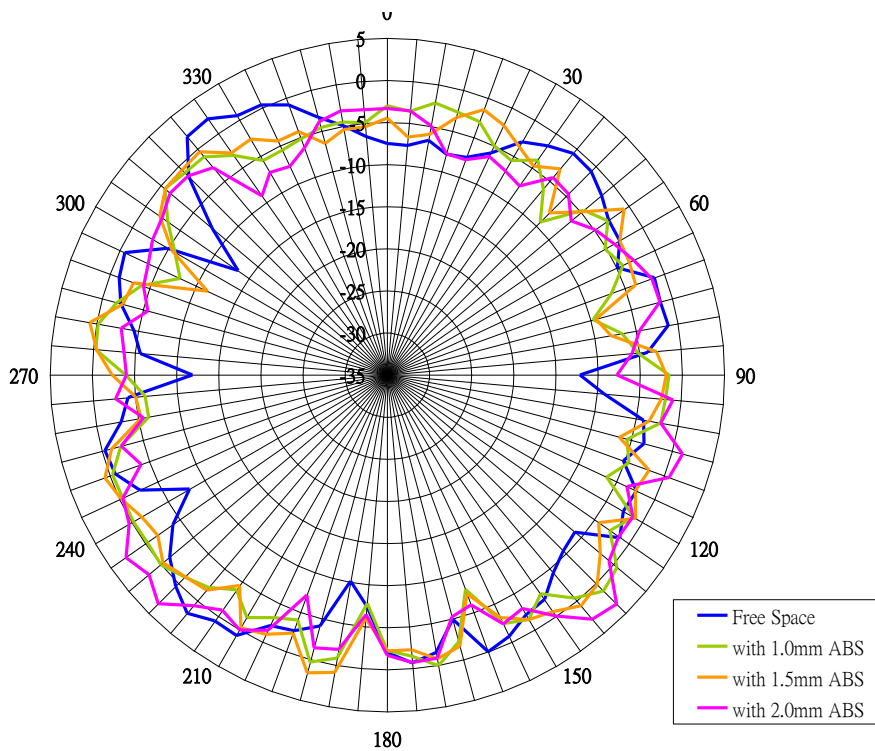

3.3.10 YZ plane (at 6000MHz)

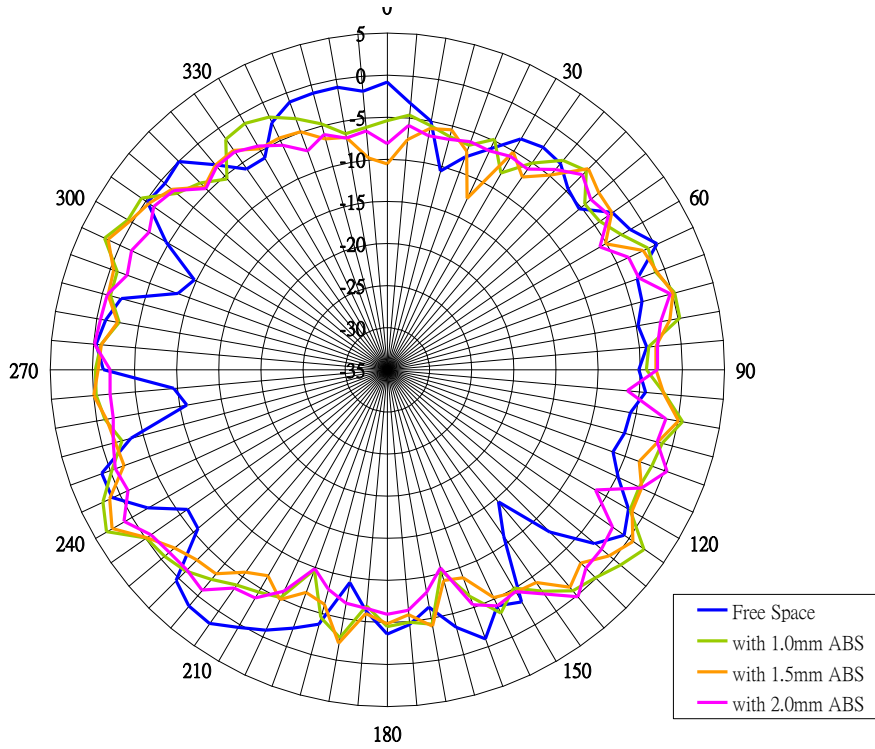

3.3.11 XY plane (at 2400MHz)

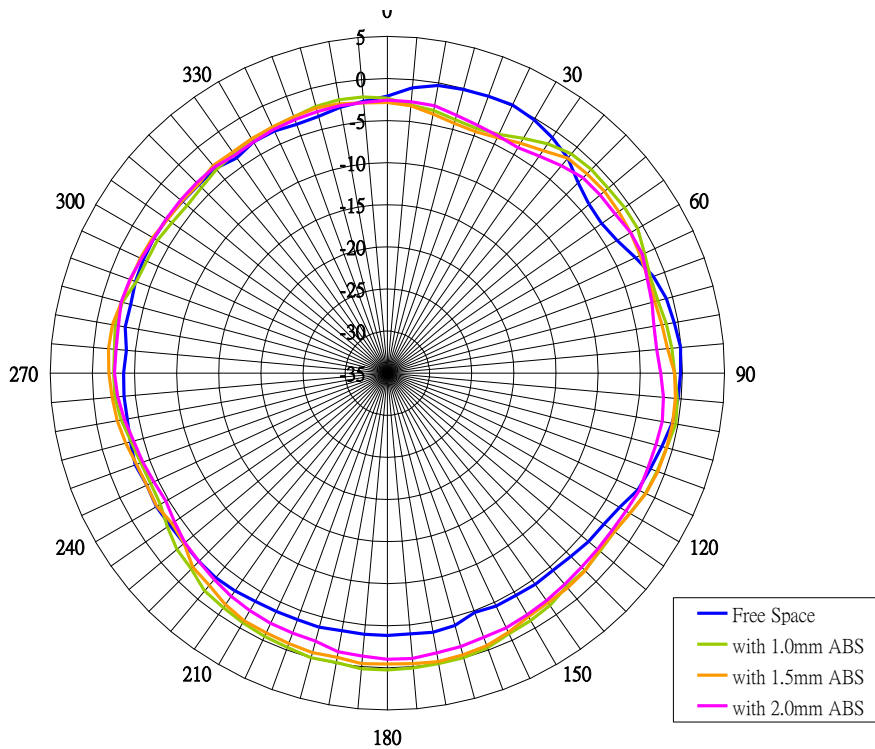

3.3.12 XY plane (at 2500MHz)

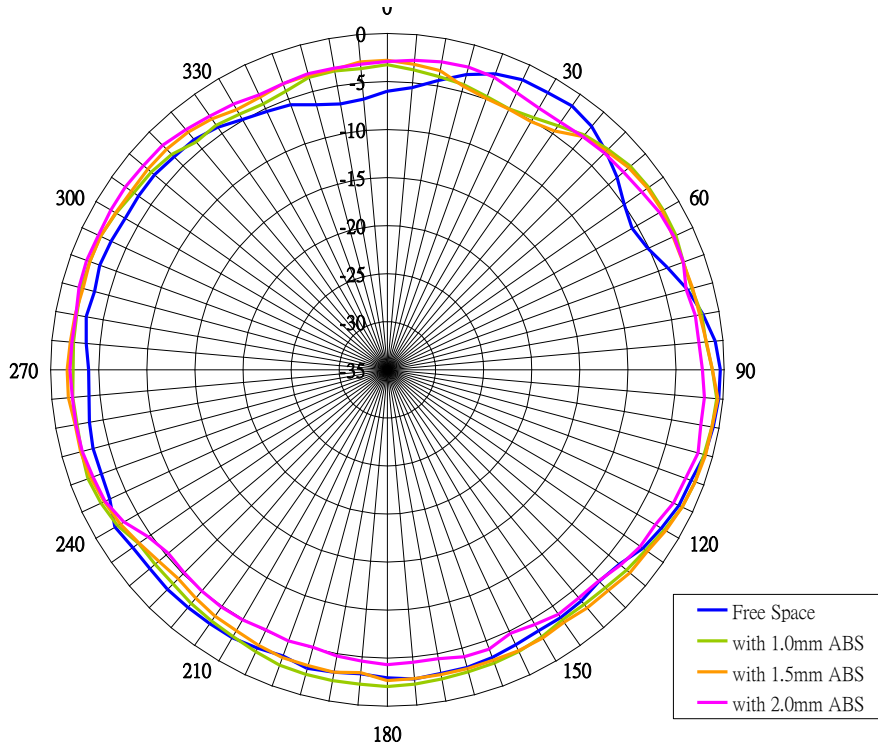

3.3.13 XY plane (at 5000MHz)

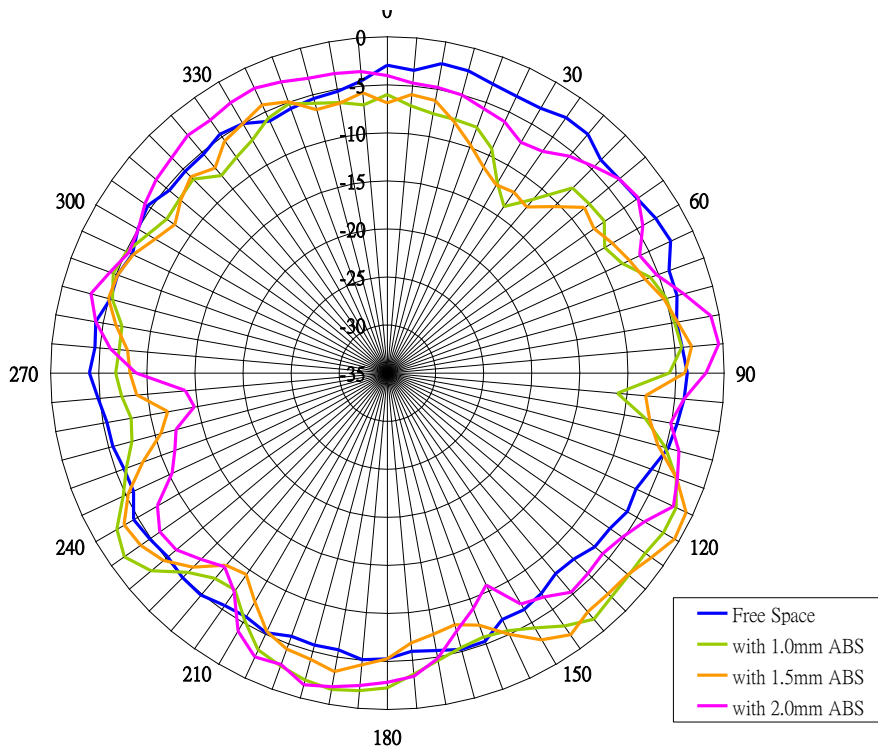

3.3.14 XY plane (at 5500MHz)

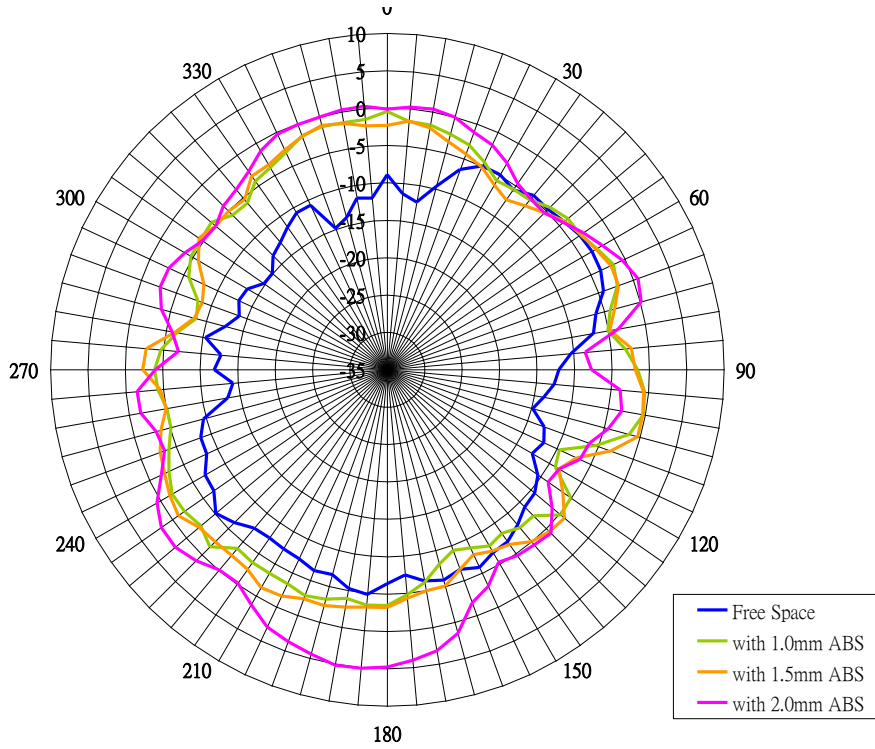

3.3.15 XY plane (at 6000MHz)

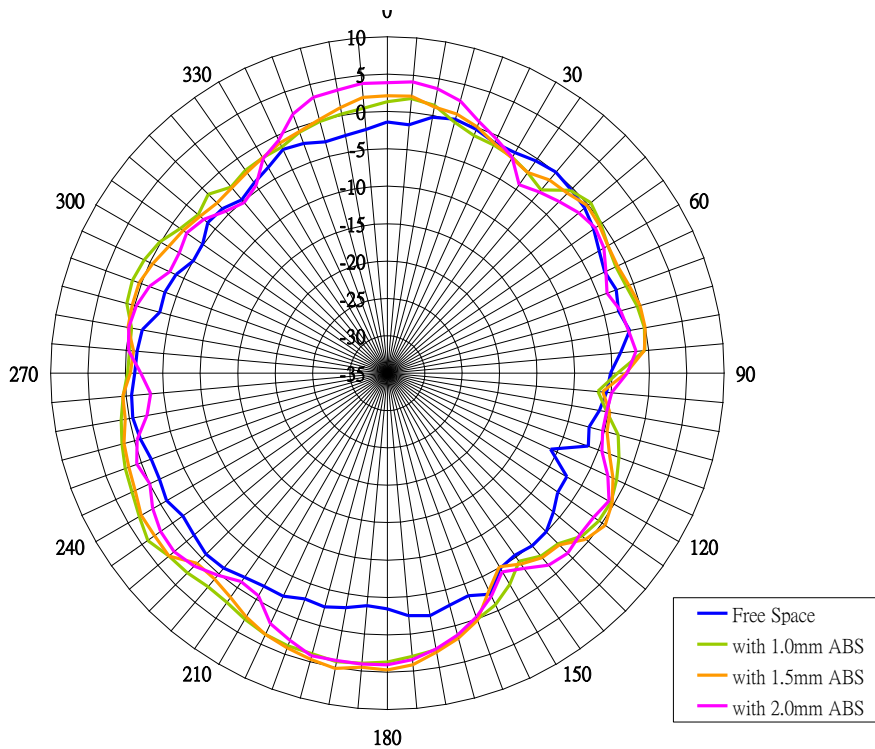

3.4 Peak Gain

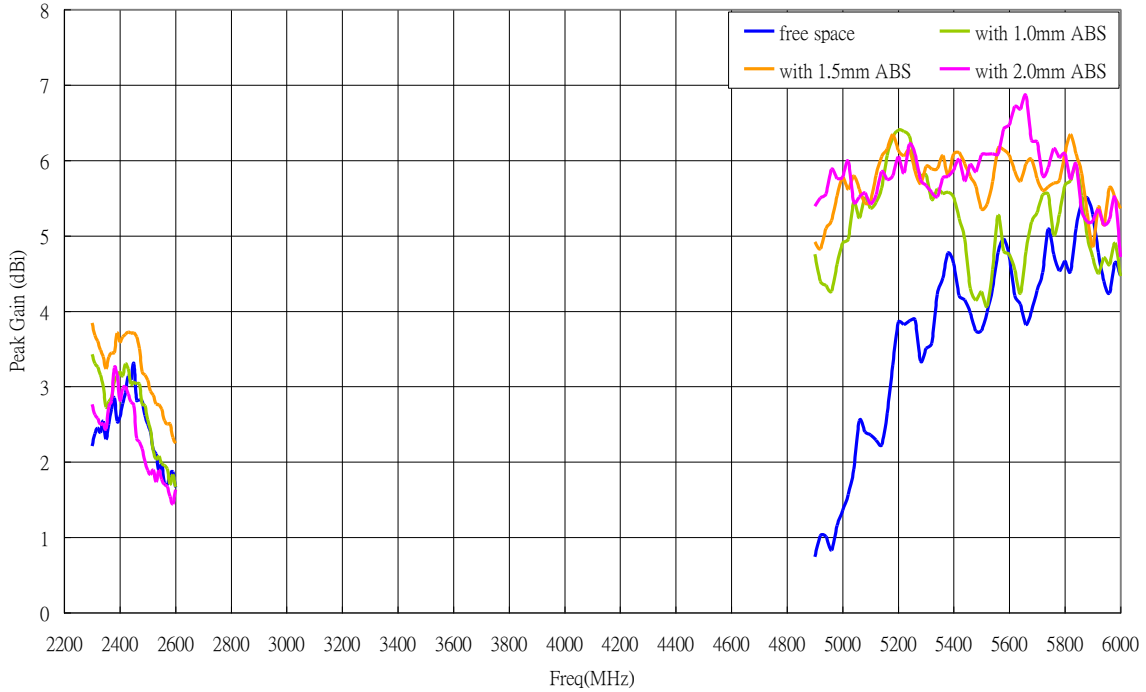

3.5 Efficiency

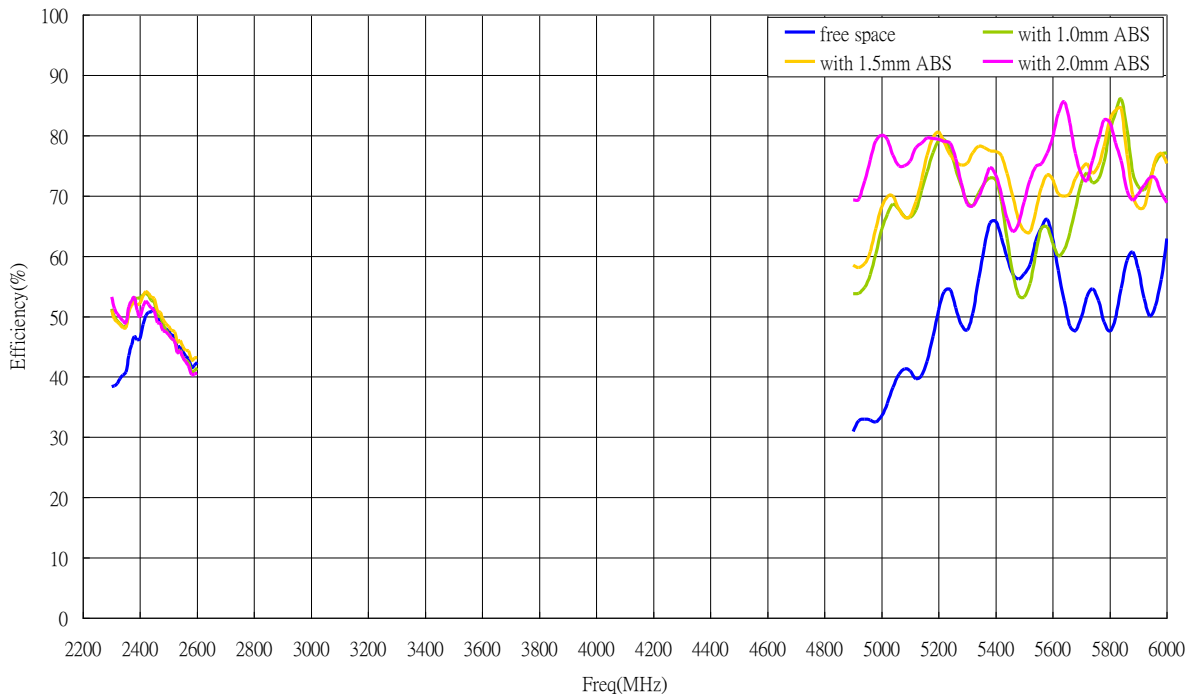

4. Mechanical

4.1 Antenna Dimension

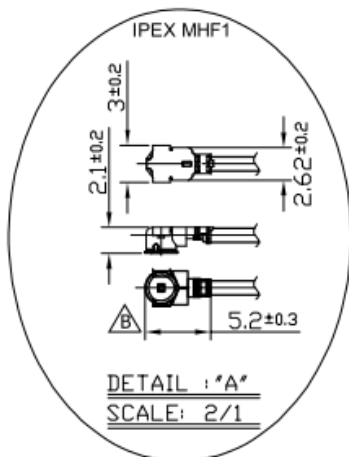
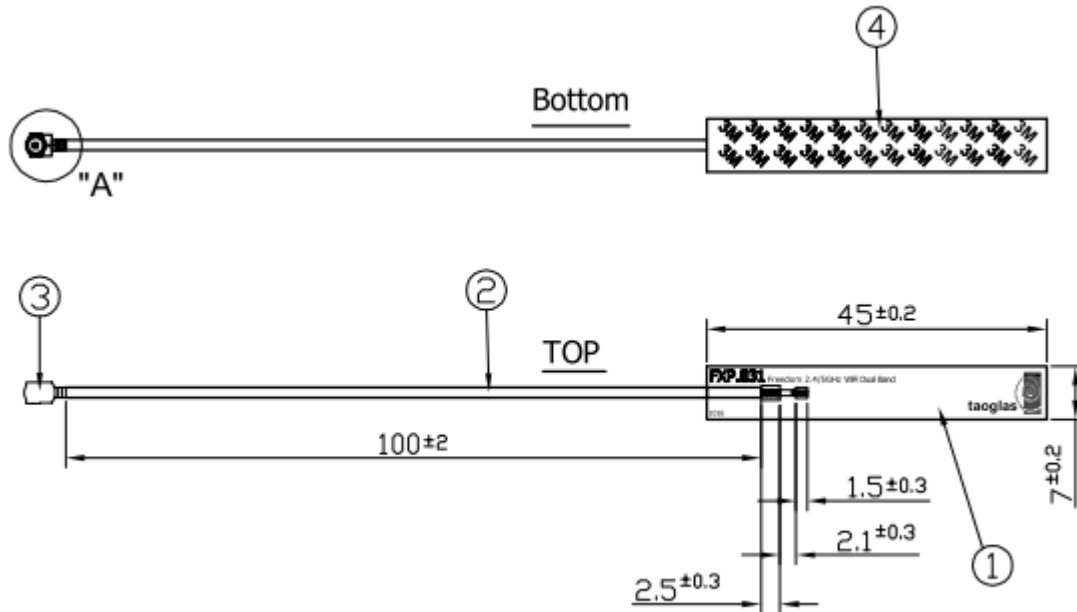

NOTES:

- 1.NO DREGS OR INSUFFICIENT SOLDERING. SOLDER THICKNESS 0.3~1.7mm
- 2.THE SOLDER MUST BE SMOOTH AND FULL TO THE EDGES OF THE PAD. THE SOLDER MUST NOT EXTEND OUTSIDE OF THE PAD AREA.
- 3.THE CONNECTOR POSITION HAS SPECIAL ORIENTATION TO THE PCB AS PER DRAWING.
- 4.ALL MATERIAL MUST BE RoHS COMPLIANT.
- 5.OPEN/SHORT QC, VSWR REQUIRED.

	Name	Material	Finish	QTY
①	FXP.B31 PCB	FPCB 0.1t	Black	1
②	1.37 Mini-Coaxial Cable	FEP	Gray	1
③	IPEX MHF1	Brass	Gold	1
④	Double-Sided Adhesive	3M 467	Brown Liner	1

5. Package

5.1 Package

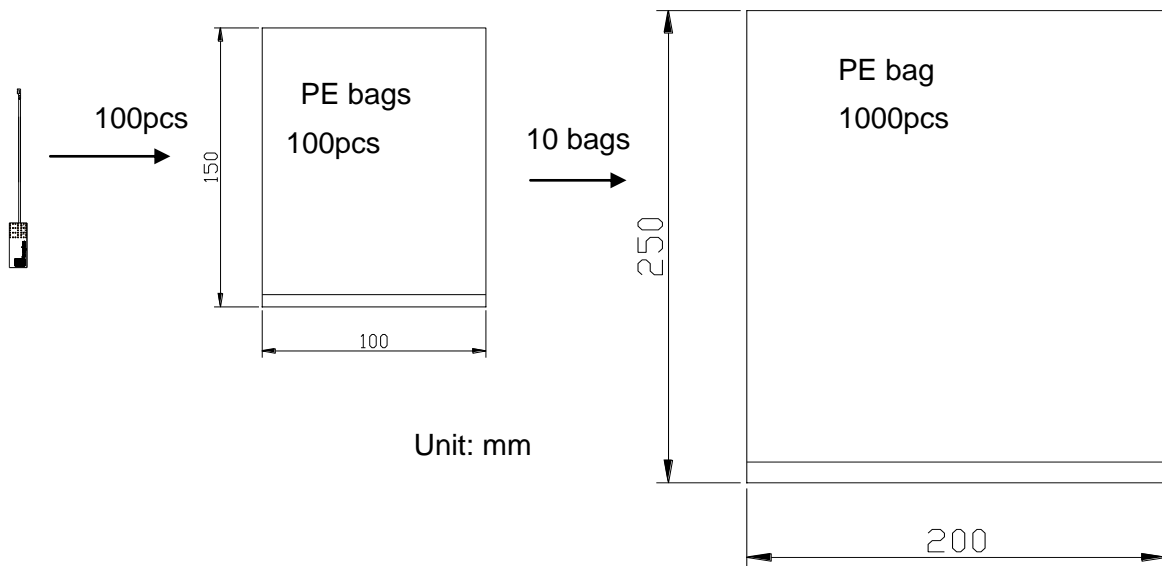

Taoglas makes no warranties based on the accuracy or completeness of the contents of this document and reserves the right to make changes to specifications and product descriptions at any time without notice.

Taoglas reserves all rights to this document and the information contained herein. Reproduction, use or disclosure to third parties without express permission is strictly prohibited. Copyright © 2012, Taoglas Ltd.