

PLEASE CHECK WWW.MOLEX.COM FOR LATEST PART INFORMATION

Part Number: [0739421000](#)
Status: **Active**
Overview: [hdm](#)
Description: 2.00mm (.079") Pitch HDM® Board-to-Board Backplane Header, Vertical, Solder Tail, Open End, 144 Circuits

Documents:

[3D Model](#) [RoHS Certificate of Compliance \(PDF\)](#)
[Drawing \(PDF\)](#)

Agency Certification

CSA LR19980
 UL E29179

General

Product Family Backplane Connectors
 Series [73942](#)
 Application Backplane
 Comments Solder Tail
 Component Type PCB Header
 Overview [hdm](#)
 Product Name HDM®
 Style N/A

Physical

Circuits (Loaded) 144
 Circuits (maximum) 144
 Color - Resin Black, Natural
 Durability (mating cycles max) 250
 First Mate / Last Break No
 Flammability 94V-0
 Guide to Mating Part No
 Keying to Mating Part None
 Material - Metal Phosphor Bronze
 Material - Plating Mating Gold
 Material - Plating Termination Tin
 Material - Resin High Temperature Thermoplastic
 Number of Columns 24
 Number of Pairs Open Pin Field
 Number of Rows 6
 Orientation Vertical
 PC Tail Length (in) 0.079 In
 PC Tail Length (mm) 2.00 mm
 PCB Retention None
 PCB Thickness Recommended (in) 0.098 In
 PCB Thickness Recommended (mm) 2.50 mm
 Packaging Type Tube
 Pitch - Mating Interface (in) 0.079 In
 Pitch - Mating Interface (mm) 2.00 mm
 Plating min: Mating (µin) 30
 Plating min: Mating (µm) 0.75
 Plating min: Termination (µin) 100
 Plating min: Termination (µm) 2.5
 Stackable Yes
 Surface Mount Compatible (SMC) Yes
 Temperature Range - Operating -55°C to +105°C

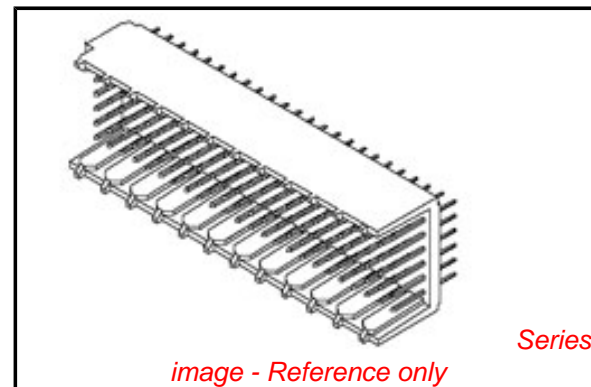

EU RoHS

**ELV and RoHS
 Compliant**
**REACH SVHC
 Not Reviewed**
**Halogen-Free
 Status
 Not Reviewed**

China RoHS



**Need more information on product
 environmental compliance?**

Email productcompliance@molex.com
 For a multiple part number RoHS Certificate of Compliance, [click here](#)

Please visit the [Contact Us](#) section for any non-product compliance questions.

Search Parts in this Series

[73942Series](#)

Mates With

[73632](#) HDM PLUS® Board-to-Board Daughtercard Receptacle. [73780](#) HDM® Board-to-Board Daughtercard Receptacle

Application Tooling | FAQ

Tooling specifications and manuals are found by selecting the products below. Crimp Height Specifications are then contained in the Application Tooling Specification document.

Global

Description	Product #
HDM® Backplane	0621001400
Insertion Signal	
Contact Tool	
Extraction Tool	0621001000

Termination Interface: Style Through Hole

Electrical

Current - Maximum per Contact 1A
Data Rate 1.0 Gbps
Voltage - Maximum 250V AC

Material Info

Reference - Drawing Numbers

Packaging Specification PK-70873-0818
Sales Drawing SD-73942-001

HDM and High Density Metric are trademarks of Amphenol Corporation

This document was generated on 05/14/2010

PLEASE CHECK WWW.MOLEX.COM FOR LATEST PART INFORMATION

NOTES:

1. MATERIALS: HOUSING--LIQUID CRYSTAL POLYMER (LCP), GLASS FILLED, UL94V-0, COLOR: BLACK, TERMINAL: PHOSPHOR BRONZE.
2. FINISH: 0.75 MICROMETERS MINIMUM SELECTIVE GOLD (Au) IN MATING AREA; 2.50 MICROMETERS MINIMUM SELECTIVE TIN (Sn) IN TAIL AREA; NICKEL (Ni) UNDERPLATE OVERALL.
3. THIS PART CONFORMS TO MOLEX PRODUCT SPECIFICATION PS-73670-9999.
4. FOR MIXED CONTACT MATING LENGTHS, CONSULT FACTORY FOR AVAILABILITY.
5. PACKAGE PER PK-70873-0818.
6. PARTS MARKED WITH PART NUMBER AND DATE CODE, ON EITHER SIDE, APPROXIMATELY WHERE SHOWN.

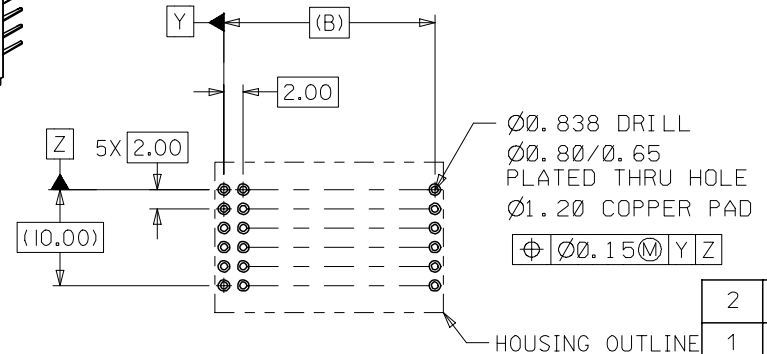
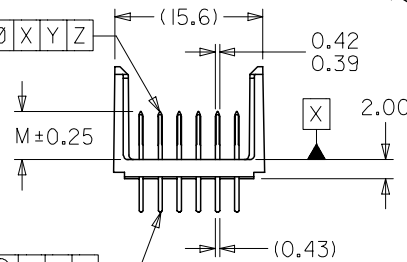
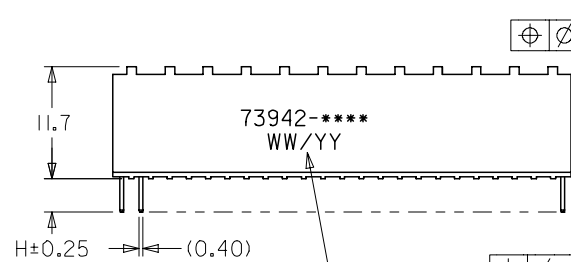
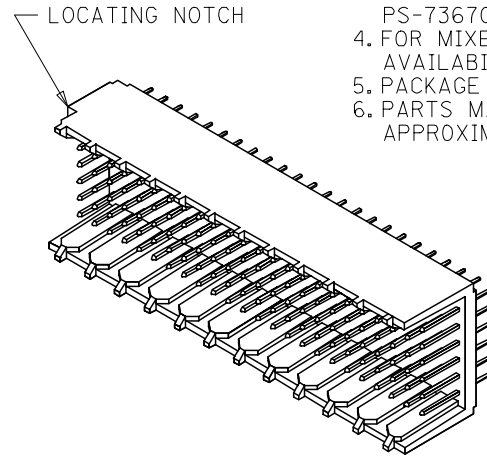
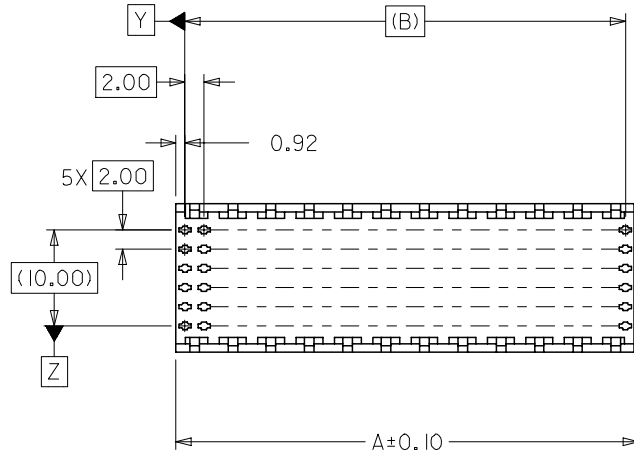

PCB LAYOUT: COMPONENT SIDE
RECOMMENDED PCB THICKNESS: 2.50 MIN.

2	A
1	G
SHT	REV

SEE NOTE 6

REV	DESCRIPTION
G	MODIFY FINISH NOTE EC NO: UCP2007-2259 IDRW:MSIBARRA 2007/03/13 CHKD:BBARKER 2007/03/21 APPR:SMILLER 2007/03/22

QUALITY SYMBOLS	DESCRIPTION
▽=0	
▽=0	

GENERAL TOLERANCES (UNLESS SPECIFIED)	
	mm
	INCH
4 PLACES	± --- ± ---
3 PLACES	± --- ± ---
2 PLACES	± 0.05 ± ---
1 PLACE	± 0.10 ± ---
ANGULAR ±1/2°	
DRAFT WHERE APPLICABLE MUST REMAIN WITHIN DIMENSIONS	

DIMENSION STYLE	
MM ONLY	
DRAWN BY	DATE
JB INGHAM	1998/01/13
CHECKED BY	DATE
SREED	1998/01/13
APPROVED BY	DATE
CBIXLER	1998/01/13
MATERIAL NO.	DOCUMENT NO.
SEE CHART	SD-73942-001



SCALE	DESIGN UNITS	THIRD ANGLE PROJECTION
2:1	METRIC	
TITLE		
SALES ASSY HDM BACKPLANE OPEN END OPTION SOLDER TAIL VERSION		
MOLEX INCORPORATED		
SHEET NO.		1 OF 2

MATERIAL NUMBER ASSIGNMENT

73942-* * 0 0

NUMBER	CIRCUIT SIZE	DIM "A"	DIM "B"	DIM "H"
0	72	23.84	22.00	2.0
1	144	47.84	46.00	2.0
2	72	23.84	22.00	2.5
3	144	47.84	46.00	2.5
4	72	23.84	22.00	3.0
5	144	47.84	46.00	3.0
6	72	23.84	22.00	3.5
7	144	47.84	46.00	3.5

NUMBER	DIM "M"
0	5.0
1	5.5
2	6.0

SEE SHEET 1 EC No. U81577 DRWN:JBINGHAM 98/0203 CHK: SREED 98/0203 APPR:CBIXLER 98/0203	MAJOR  CRITICAL 	QUALITY SYMBOLS	GENERAL TOLERANCES: (UNLESS SPECIFIED)	SCALE ---:--	DESIGN UNITS <input checked="" type="checkbox"/> mm <input type="checkbox"/> INCH	DIMENSIONS: <input type="checkbox"/> mm <input type="checkbox"/> INCH <input checked="" type="checkbox"/> mm ONLY	SHT REV		
		DRAWN BY & DATE JBINGHAM 98/01/13	THIRD ANGLE PROJECTION 		CHECKED BY & DATE SREED 98/01/13		TITLE: SALES ASSY, HDM BACKPLANE OPEN END OPTION SOLDER TAIL VERSION		
		APPROVED BY & DATE CBIXLER 98/01/13	ANGLAR: ± °		CAD FILENAME S73942X2.DGN		MOLEX INCORPORATED		SHEET NO. 2
		DRAFT WHERE APPLICABLE MUST REMAIN WITHIN DIMENSIONS	THIS DRAWING CONTAINS INFORMATION THAT IS PROPRIETARY TO MOLEX INCORPORATED AND SHOULD NOT BE USED WITHOUT WRITTEN PERMISSION.		MATERIAL NO. SEE CHART		DRAWING NO. SD-73942-001		SIZE B