

NPN SILICON POWER TRANSISTOR ARRAY  
 HIGH SPEED SWITCHING USE (DARLINGTON TRANSISTOR)  
 INDUSTRIAL USE

DESCRIPTION

The  $\mu$ PA1436A is NPN silicon epitaxial Darlington Power Transistor Array that built in 4 circuits designed for driving solenoid, relay, lamp and so on.

FEATURES

- Easy mount by 0.1 inch of terminal interval.
- High  $h_{FE}$  for Darlington Transistor.
- C-E Reverse Diode built in.
- High Speed Switching.

ORDERING INFORMATION

Part Number	Package	Quality Grade
$\mu$ PA1436AH	10 Pin SIP	Standard

Please refer to "Quality grade on NEC Semiconductor Device" (Document number IEI-1209) published by NEC Corporation to know the specification of quality grade on the devices and its recommended applications.

ABSOLUTE MAXIMUM RATINGS ( $T_a = 25\text{ }^\circ\text{C}$ )

Collector to Base Voltage	$V_{CBO}$	150	V
Collector to Emitter Voltage	$V_{CEO}$	100	V
Emitter to Base Voltage	$V_{EBO}$	8	V
Collector Current (DC)	$I_{C(DC)}$	$\pm 3$	A/unit
Collector Current (pulse)	$I_{C(pulse)^*}$	$\pm 5$	A/unit
Base Current (DC)	$I_{B(DC)}$	0.3	A/unit
Total Power Dissipation ( $T_a = 25\text{ }^\circ\text{C}$ )	$P_{T1}^{**}$	3.5	W
Total Power Dissipation ( $T_c = 25\text{ }^\circ\text{C}$ )	$P_{T2}^{**}$	28	W
Junction Temperature	$T_j$	150	$^\circ\text{C}$
Storage Temperature	$T_{stg}$	-55 to +150	$^\circ\text{C}$
* $PW \leq 350\ \mu s$ , Duty Cycle $\leq 2\%$			
** 4 Circuits			

PACKAGE DIMENSION  
(in millimeters)

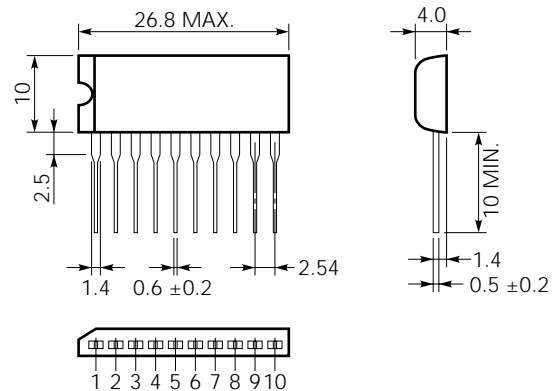

CONNECTION DIAGRAM

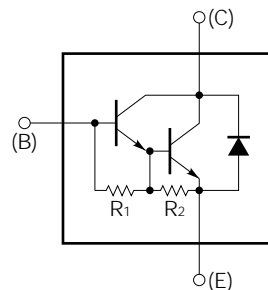
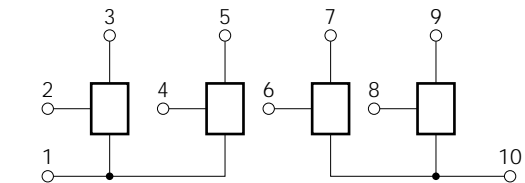

PIN NO.

- 2, 4, 6, 8: Base (B)
- 3, 5, 7, 9: Collector (C)
- 1, 10: Emitter (E)
- $R_1 \cong 5\text{ k}\Omega$
- $R_2 \cong 1.3\text{ k}\Omega$

The information in this document is subject to change without notice.

ELECTRICAL CHARACTERISTICS (T<sub>a</sub> = 25 °C)

CHARACTERISTIC	SYMBOL	MIN.	TYP.	MAX.	UNIT	TEST CONDITIONS
Collector Leakage Current	I <sub>CBO</sub>			1	μA	V <sub>CB</sub> = 100 V, I <sub>E</sub> = 0
Emitter Leakage Current	I <sub>EBO</sub>			5	mA	V <sub>EB</sub> = 5 V, I <sub>C</sub> = 0
DC Current Gain	h <sub>FE1</sub> *	2000		20000	—	V <sub>CE</sub> = 2 V, I <sub>C</sub> = 1.5 A
DC Current Gain	h <sub>FE2</sub> *	1000			—	V <sub>CE</sub> = 2 V, I <sub>C</sub> = 3 A
Collector Saturation Voltage	V <sub>CE(sat)</sub> *		1	1.5	V	I <sub>C</sub> = 1.5 A, I <sub>B</sub> = 1.5 mA
Base Saturation Voltage	V <sub>BE(sat)</sub> *		1.8	2	V	I <sub>C</sub> = 1.5 A, I <sub>B</sub> = 1.5 mA
Turn On Time	t <sub>on</sub>		0.3		μs	I <sub>C</sub> = 1.5 A I <sub>B1</sub> = -I <sub>B2</sub> = 3 mA V <sub>CC</sub> ≅ 50 V, R <sub>L</sub> = 33 Ω
Storage Time	t <sub>stg</sub>		1.5		μs	
Fall Time	t <sub>f</sub>		0.4		μs	

\* PW ≤ 350 μs, Duty Cycle ≤ 2 % /pulsed

SWITCHING TIME TEST CIRCUIT

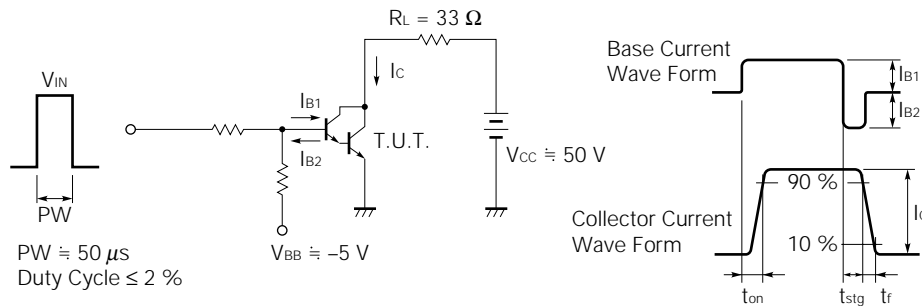

TYPICAL CHARACTERISTICS ( $T_a = 25^\circ\text{C}$ )

DERATING CURVE OF SAFE OPERATING AREA

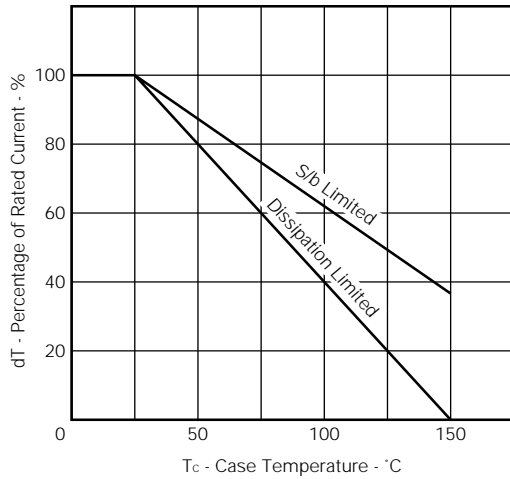

SAFE OPERATING AREA

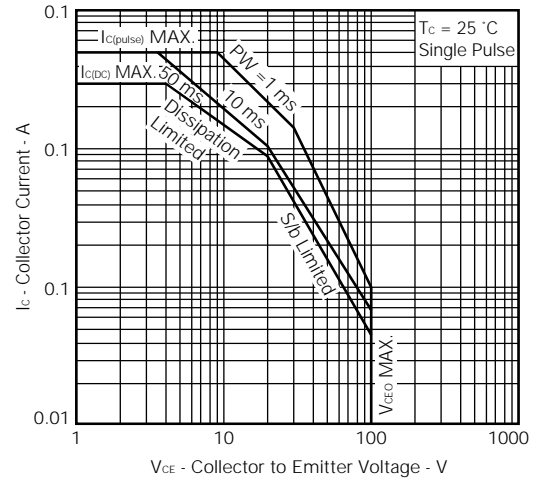

TOTAL POWER DISSIPATION vs. AMBIENT TEMPERATURE

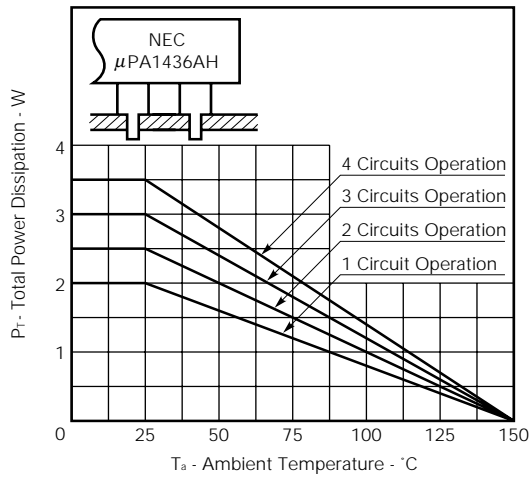

TOTAL POWER DISSIPATION vs. CASE TEMPERATURE

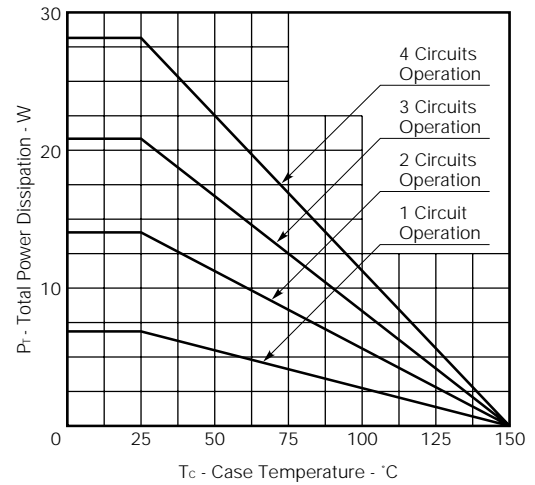

COLLECTOR CURRENT vs. COLLECTOR TO EMITTER VOLTAGE

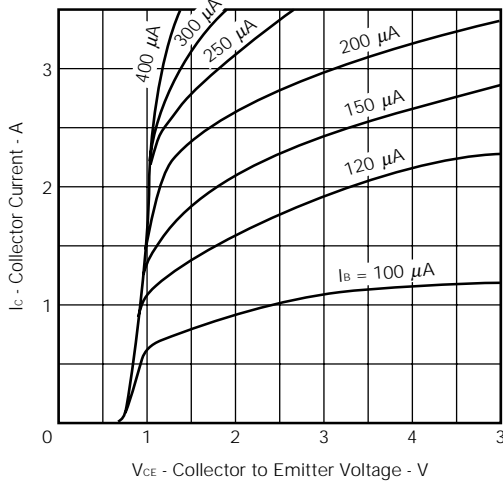

COLLECTOR CURRENT vs. BASE TO EMITTER VOLTAGE

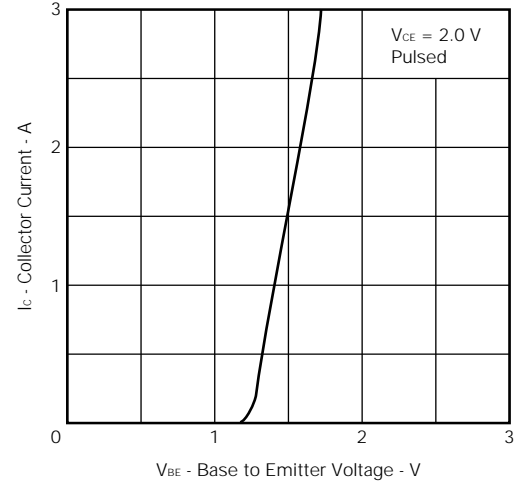

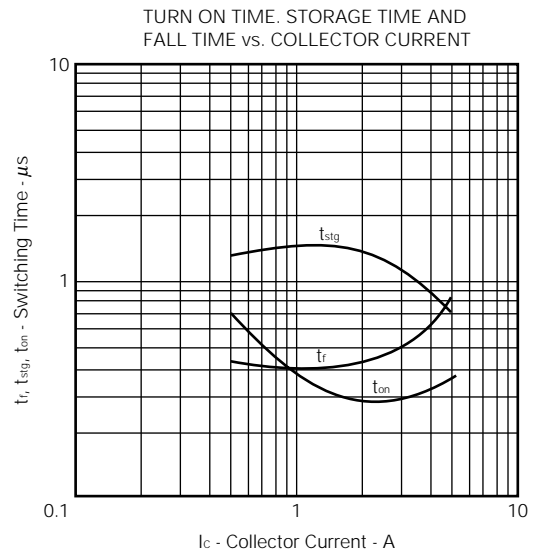
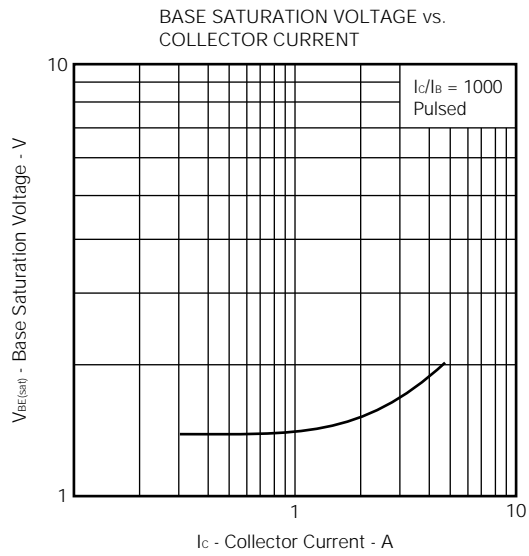
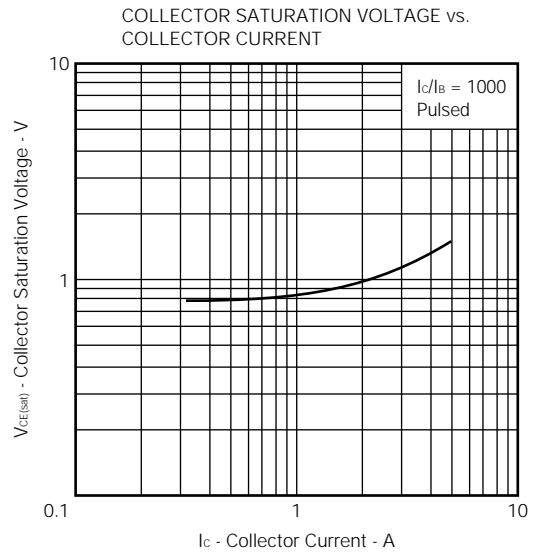
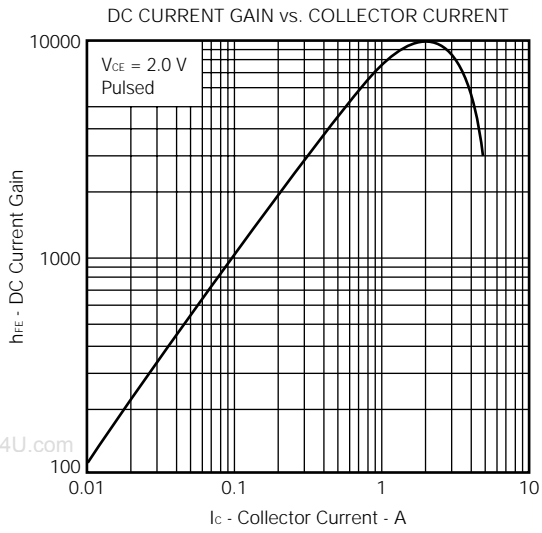

## REFERENCE

Document Name	Document No.
NEC semiconductor device reliability/quality control system.	TEI-1202
Quality grade on NEC semiconductor devices.	IEI-1209
Semiconductor device mounting technology manual.	IEI-1207
Semiconductor device package manual.	IEI-1213
Guide to quality assurance for semiconductor devices.	MEI-1202
Semiconductor selection guide.	MF-1134

[MEMO]

www.DataSheet4U.com

No part of this document may be copied or reproduced in any form or by any means without the prior written consent of NEC Corporation. NEC Corporation assumes no responsibility for any errors which may appear in this document.

NEC Corporation does not assume any liability for infringement of patents, copyrights or other intellectual property rights of third parties by or arising from use of a device described herein or any other liability arising from use of such device. No license, either express, implied or otherwise, is granted under any patents, copyrights or other intellectual property rights of NEC Corporation or others.

The devices listed in this document are not suitable for use in aerospace equipment, submarine cables, nuclear reactor control systems and life support systems. If customers intend to use NEC devices for above applications or they intend to use "Standard" quality grade NEC devices for applications not intended by NEC, please contact our sales people in advance.

Application examples recommended by NEC Corporation

Standard: Computer, Office equipment, Communication equipment, Test and Measurement equipment, Machine tools, Industrial robots, Audio and Visual equipment, Other consumer products, etc.

Special: Automotive and Transportation equipment, Traffic control systems, Antidisaster systems, Anticrime systems, etc.

M4 92.6