

EARTH LEAKAGE CURRENT DETECTOR

# Automotive EARTH LEAKAGE CURRENT DETECTOR IC



**BD9582F-M**

● **General Description**

BD9582F-M integrates leakage detector and amplifier. Especially, it is suitable for high sensitivity and a high-speed operation use, and since the operating temperature range is wide, it can be used for various uses.

● **Key Specifications**

- Operating supply voltage range : 12V to 22V
- Operating temperature range :  $-40^{\circ}\text{C}$  to  $+105^{\circ}\text{C}$
- Supply current :  $330\ \mu\text{A}$ (typ.)
- Trip voltage : 4.48mV to 11.06mV
- Output current ability( $T_a = -40^{\circ}\text{C}$ ) :  $-200\ \mu\text{A} \sim$ (min.)

● **Features**

- Small temperature fluctuation and high input sensitivity
- Wide operating temperature range

● **Packages**  
SOP8

W(Typ.) x D(Typ.) x H(Max.)  
5.00mm x 6.20mm x 1.71mm

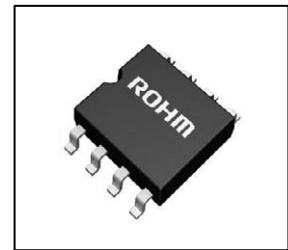

● **Applications**

- Earth leakage circuit breaker
- Earth leakage circuit relay

● **Typical Application Circuit Example**

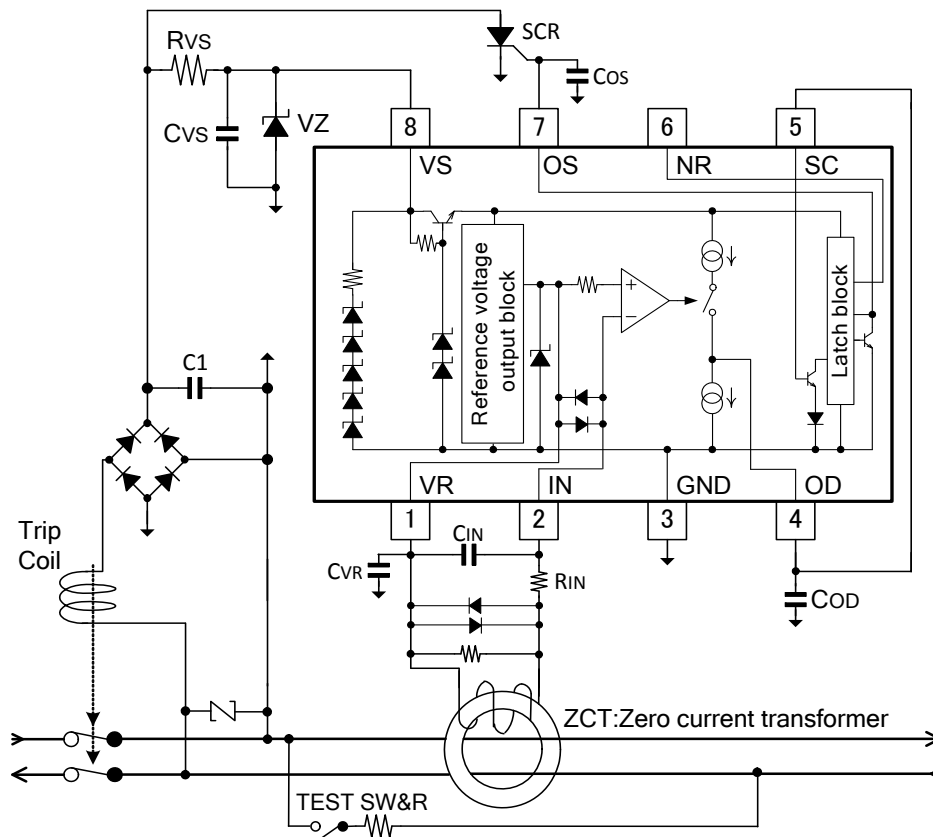

○Product structure : Silicon monolithic integrated circuit ○This product is not designed protection against radioactive rays.

●Pin Configurations

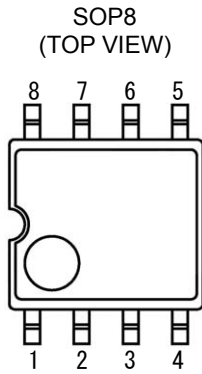

●Block Diagrams

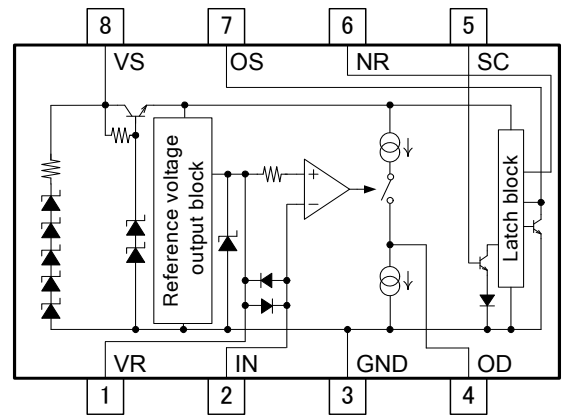

●Pin Descriptions

Pin No.	Symbol	Function
1	VR	Reference voltage
2	IN	Input
3	GND	Ground
4	OD	Output of input comparator
5	SC	Input of latch circuit
6	NR	Noise absorption
7	OS	Output
8	VS	Power supply

●Absolute Maximum Ratings

(Ta=25°C)

Parameter	Symbol	Rating	Unit
Supply current *1	IS	8	mA
IN-VR current	IIN-VR	±250	mA
VR pin current	IVR	30	mA
IN terminal current	IIN	30	mA
SC terminal current	ISC	5	mA
Power Supply voltage	VS	36	V
Input terminal voltage	VVR/IN	17	V
OD/SC/NR/OS terminal voltage	VOD/SC/NR/OS	8	V
Power dissipation	Pd	680 *2	mW
Storage temperature	Tstg	-55 to +150	°C

\*1 The power-supply voltage is limited by the internal clamping circuit.

\*2 To use at temperature above Ta=25°C reduce 5.5mW/°C. Mounted on a glass epoxy PCB (70mm×70mm×1.6mm)

### ● Recommended Operating Ratings

Parameter	Symbol	Limits	Unit
Supply voltage	VS	12 to 22	V
Operating temperature	T <sub>opr</sub>	-40 to +105	°C
External capacitor between VS and GND	C <sub>vs</sub>	1 ≤	μF
External capacitor between OS and GND	C <sub>os</sub>	≤ 1	μF

### ● Electrical Characteristics

(Unless otherwise specified, VS=12V, GND=0V, Ta=25°C)

Parameter	Symbol	Temperature range	Limits			Unit	Conditions
			Min.	Typ.	Max.		
Supply current	IS1	-40°C	-	-	520	μA	ΔVIN=VVR-VIN=30mV
		25°C	-	330	500		
		105°C	-	-	460		
Trip voltage	VT	-40°C to +105°C	4.48	7.50	11.06	mV	VT=ΔVIN=VVR-VIN
OD Source current	I <sub>ODSO</sub>	25°C	-27.2	-20.6	-14.0	μA	ΔVIN=VVR-VIN=30mV, V <sub>OD</sub> =1.2V
OD Sink current	I <sub>ODSI</sub>	25°C	16.7	26.0	35.3	μA	V <sub>OD</sub> =0.8V, ΔVIN=VVR-VIN=0mV
OS Source current	I <sub>OSSO</sub>	-40°C	-200	-	-	μA	V <sub>sc</sub> =2.0V, V <sub>os</sub> =0.8V
		25°C	-100	-	-		
		105°C	-75	-	-		
OS Sink current	I <sub>OSSI</sub>	-40°C to +105°C	200	-	-	μA	V <sub>sc</sub> =0.2V, V <sub>os</sub> =0.2V
SC ON voltage	V <sub>SCON</sub>	25°C	1.00	1.24	1.48	V	
Input clamp voltage	V <sub>IC</sub>	-40°C to +105°C	4.2	5.5	6.8	V	I <sub>IC</sub> =20mA
Differential input clamp voltage	V <sub>IDC</sub>	-40°C to +105°C	0.5	1.0	1.5	V	I <sub>IDC</sub> =100mA
Maximum current voltage	V <sub>SM</sub>	25°C	26	29	32	V	I <sub>S</sub> =7mA
Supply current 2 *1	I <sub>OS2</sub>	-40°C to +105°C	-100	-	-	μA	I <sub>S</sub> =900μA, V <sub>sc</sub> =2.0V, V <sub>os</sub> =0.8V
Latch OFF Supply Voltage	V <sub>SOFF</sub>	25°C	2.7	3.7	4.7	V	
Operating time *2	t <sub>ON</sub>	25°C	1.8	2.9	4.0	Ms	

\*1 Supply current 2 is OS source current value when the power supply current(I<sub>S</sub>=900μA) is given.

\*2 Operating time is time until output voltage reaches 0.8V after detecting the leakage signal.

Conditions : Capacitor(0.047μF) is connected between OD(OS) and GND.

● Test circuits

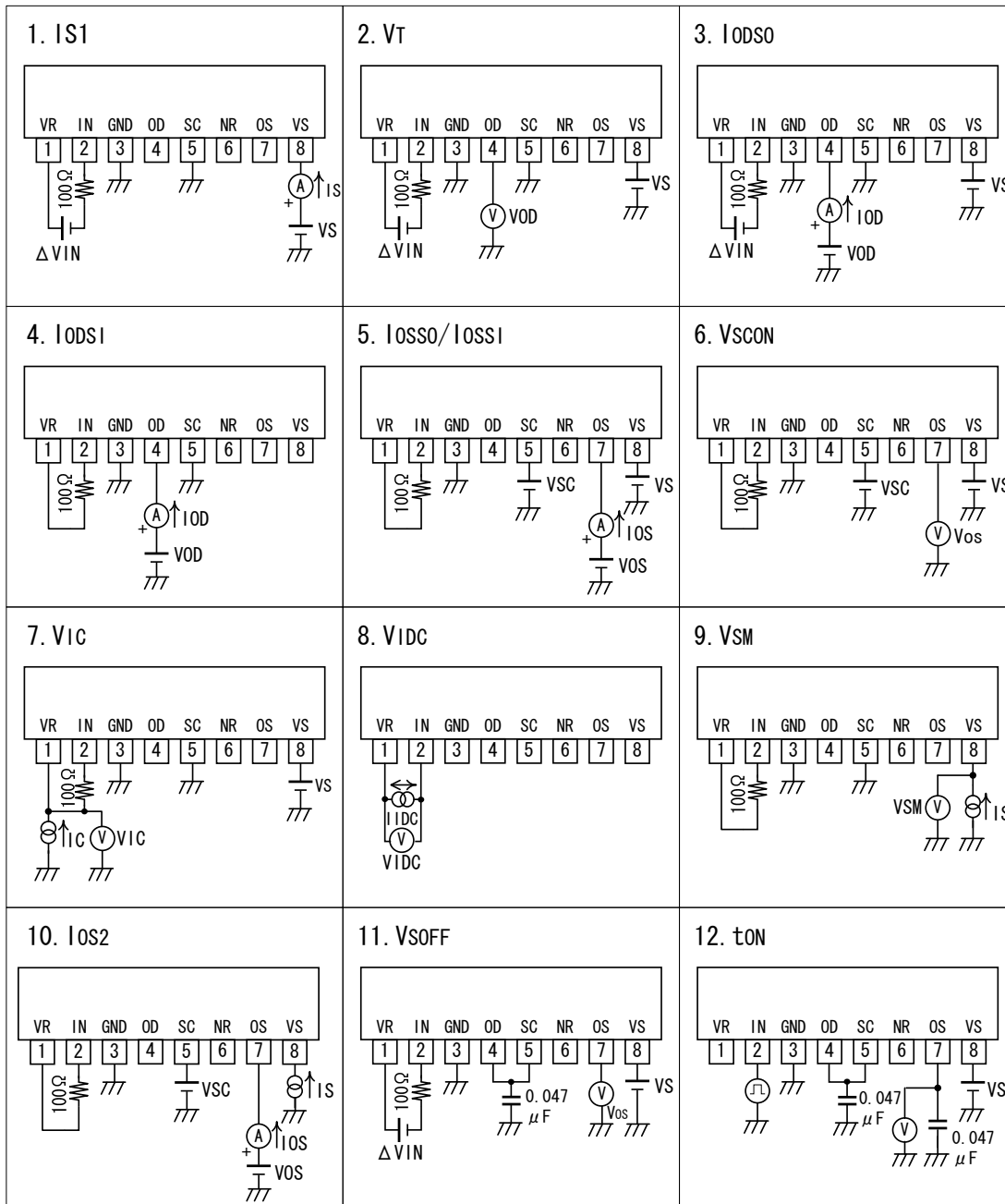

● Timing Chart

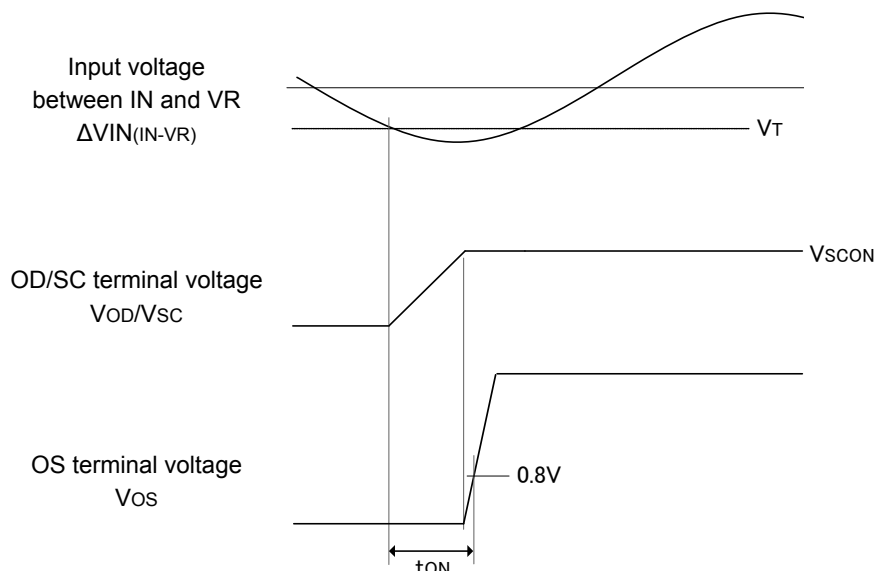

● Typical Performance Curves(reference data)

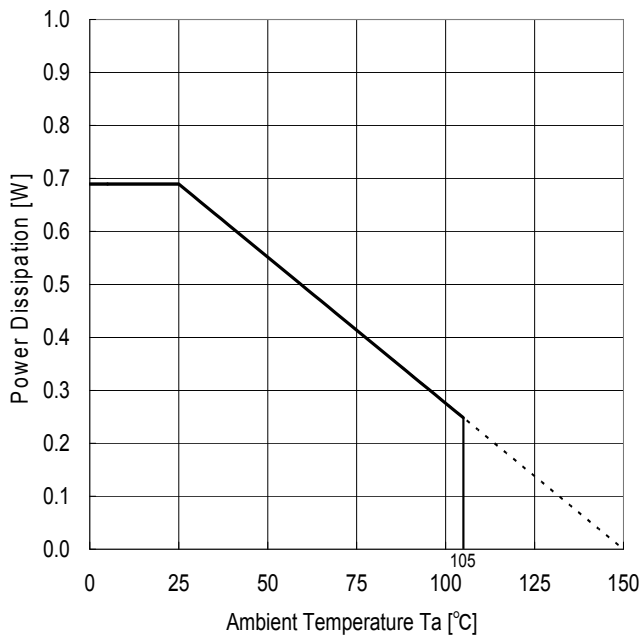

Figure 1  
Derating curve

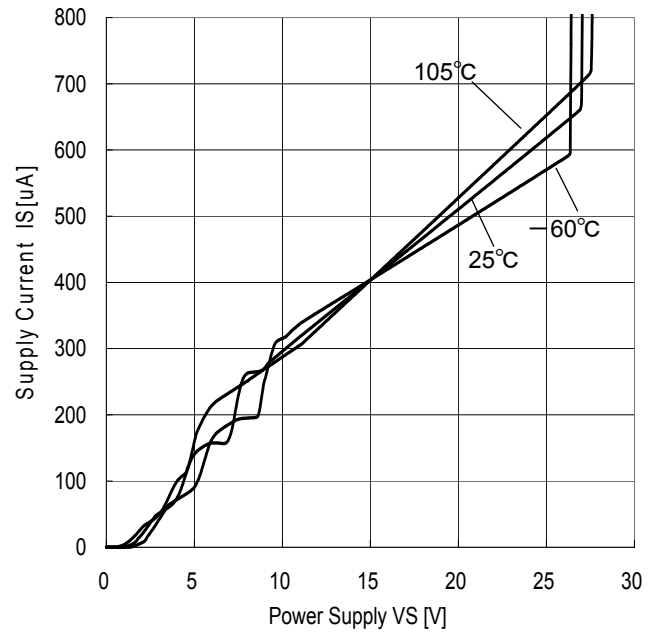

Figure 2  
Circuit current - Supply voltage

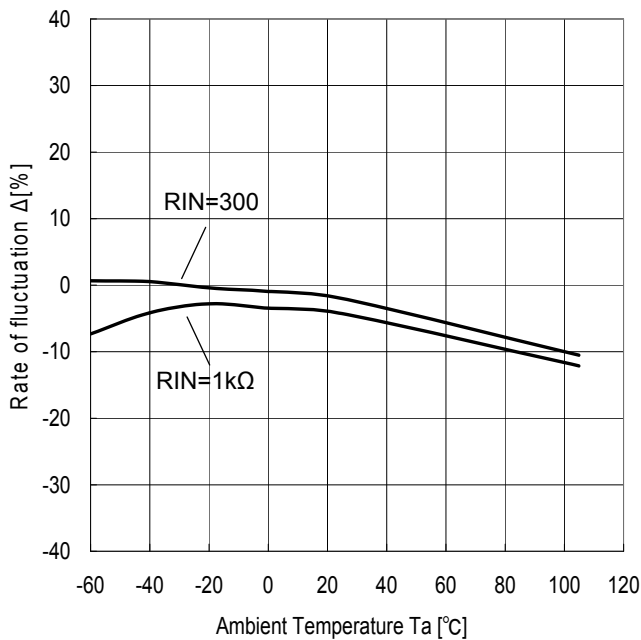

Figure 3  
Trip voltage fluctuation rate  
- Ambient temperature

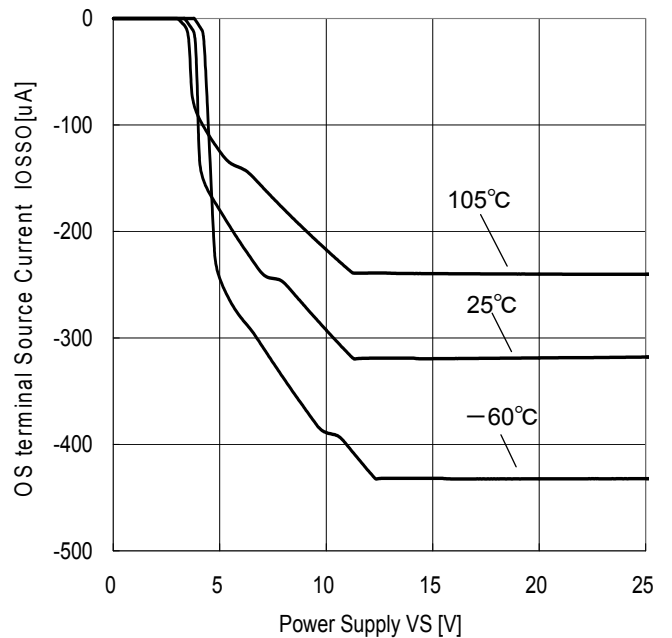

Figure 4  
OS terminal source current - Supply voltage

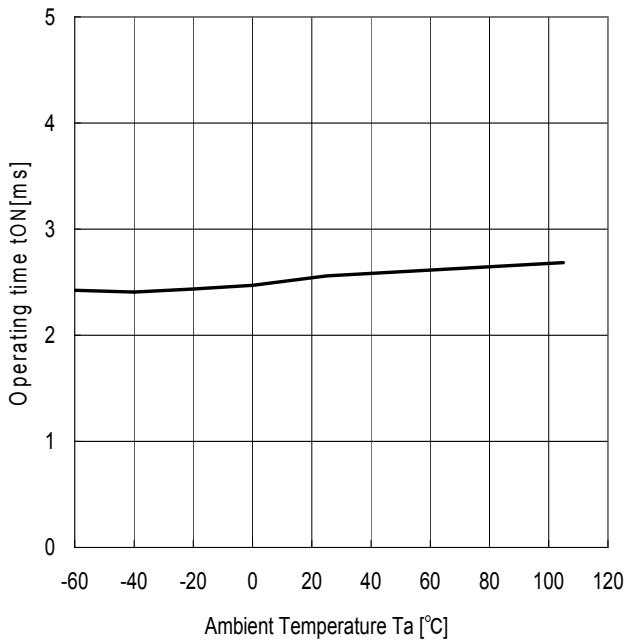

Figure 5  
Operating time - Ambient temperature

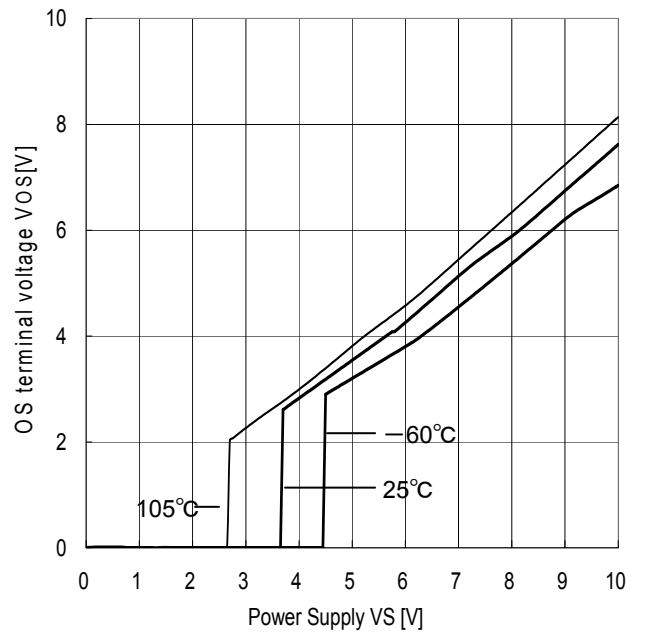

Figure 6  
Latch OFF supply voltage - Ambient temperature

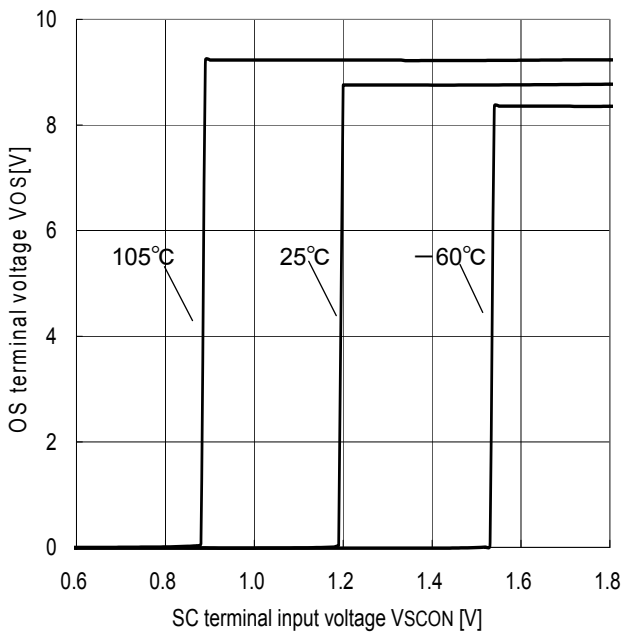

Figure 7  
SC ON voltage - Ambient temperature

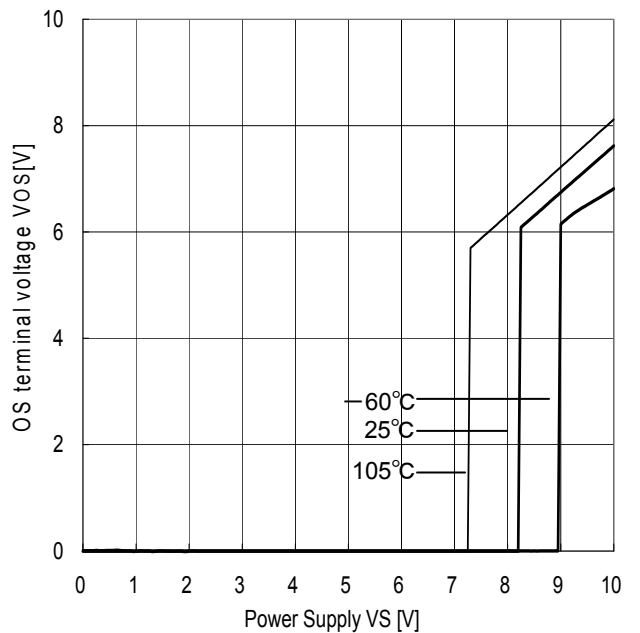

Figure 8  
Latch ON supply voltage - Ambient temperature

●Power Dissipation

Power dissipation(total loss) indicates the power that can be consumed by IC at Ta=25°C(normal temperature).IC is heated when it consumed power, and the temperature of IC chip becomes higher than ambient temperature. The temperature that can be accepted by IC chip depends on circuit configuration, manufacturing process, and consumable power is limited. Power dissipation is determined by the temperature allowed in IC chip (maximum junction temperature) and thermal resistance of package (heat dissipation capability). The maximum junction temperature is typically equal to the maximum value in the storage temperature range. Heat generated by consumed power of IC radiates from the mold resin or lead frame of the package. The parameter which indicates this heat dissipation capability(hardness of heat release)is called thermal resistance, represented by the symbol  $\theta_{ja}$ °C/W.The temperature of IC inside the package can be estimated by this thermal resistance. Fig.9(a) shows the model of thermal resistance of the package. Thermal resistance  $\theta_{ja}$ , ambient temperature Ta, junction temperature Tj, and power dissipation Pd can be calculated by the equation below

$$\theta_{ja} = (T_j - T_a) / P_d \quad \text{°C/W} \quad \dots \dots \dots (I)$$

Derating curve in Fig.9(b) indicates power that can be consumed by IC with reference to ambient temperature. Power that can be consumed by IC begins to attenuate at certain ambient temperature. This gradient is determined by thermal resistance  $\theta_{ja}$ . Thermal resistance  $\theta_{ja}$  depends on chip size, power consumption, package, ambient temperature, package condition, wind velocity, etc even when the same of package is used. Thermal reduction curve indicates a reference value measured at a specified condition. Fig.10(a) show a derating curve for an example of BD9582F-M.

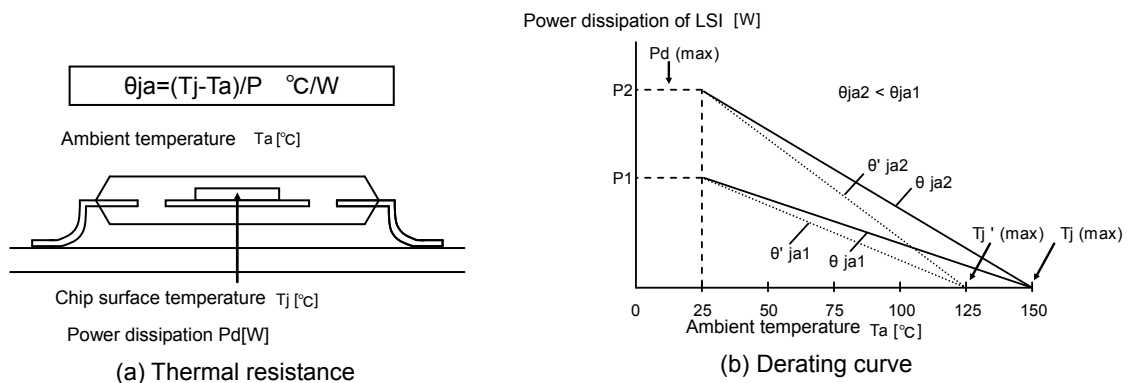
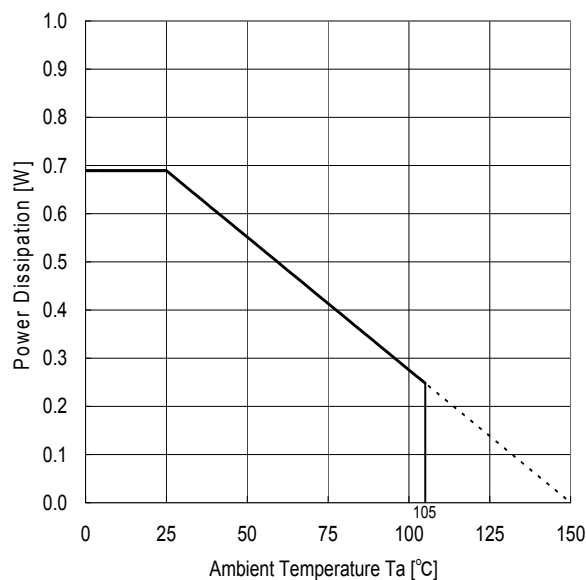

Figure 9. Thermal resistance and derating



(a) BD9582F-M

	Derating curve slope	UNIT
BD9582F-M	5.5	mW/°C

When using the unit above Ta=25°C, subtract the value above per degree°C  
Permissible dissipation is a value when FR4 glass epoxy board 70mm×70mm×1.6mm (cooper foil area below 3%) is mounted.

Figure 10. Derating curve

● I/O equivalence circuit

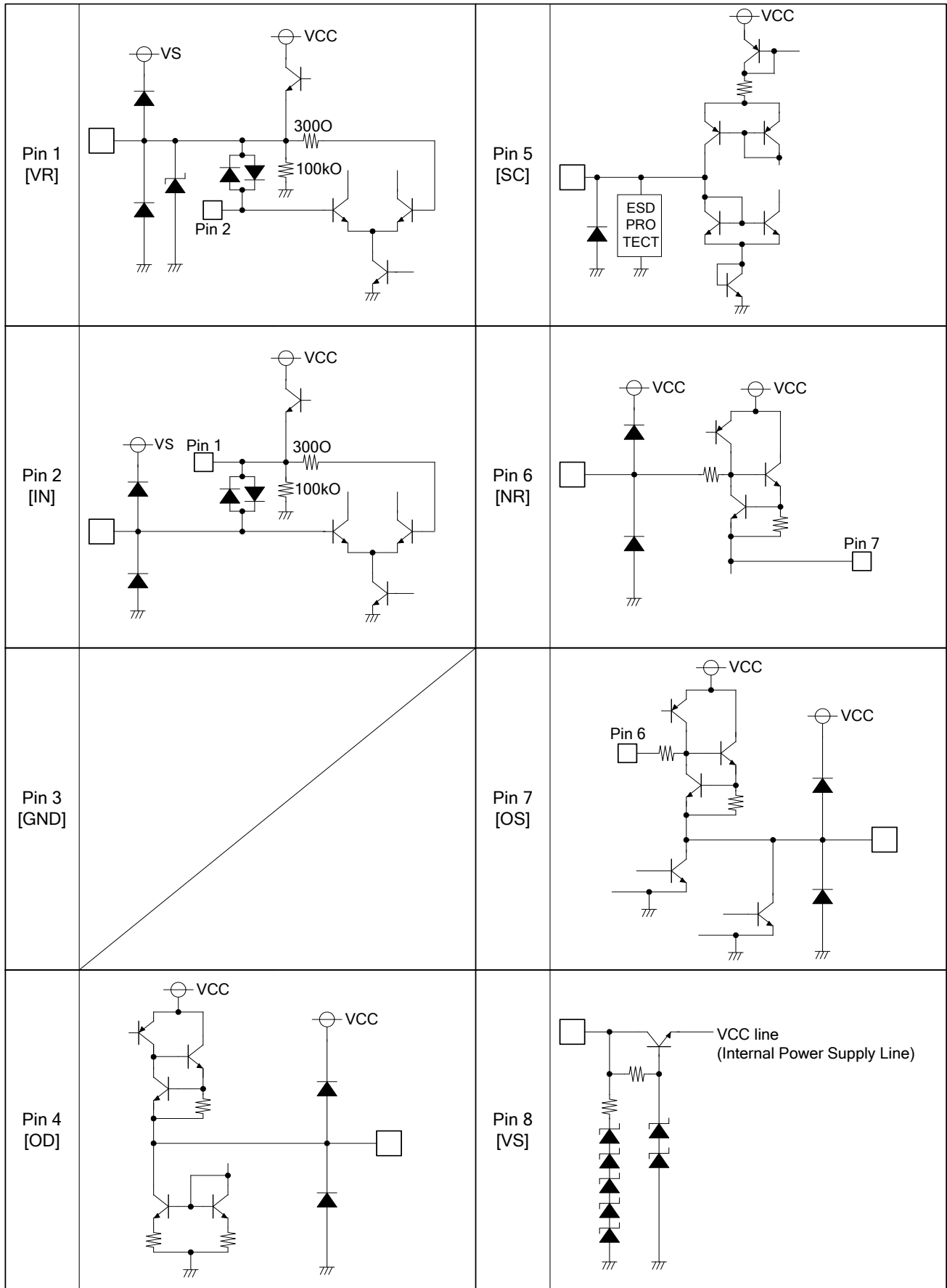



**●Operational Notes**

- 1) Absolute maximum ratings  
Absolute maximum ratings are the values which indicate the limits, within which the given voltage range can be safely charged to the terminal. However, it does not guarantee the circuit operation.
- 2) Power dissipation Pd  
Using the unit in excess of the rated power dissipation may cause deterioration in electrical characteristics due to a rise in chip temperature, including reduced current capability. Therefore, please take into consideration the power dissipation (Pd) under actual operating conditions and apply a sufficient margin in thermal design. Refer to the thermal derating curves for more information.
- 3) Terminal short-circuits  
When the output and power supply terminals are shorted, excessive output current may flow, resulting in undue heat generation and, subsequently, destruction.
- 4) Ground terminal voltage  
All time, Ground terminal voltage should keep lowest voltage.  
In addition, please confirm whether there is not really a terminal becoming the voltage that is lower than GND including a transitional phenomenon.
- 5) Operation in a strong electromagnetic field  
Operation in a strong electromagnetic field may cause malfunctions.
- 6) Short-circuit between pins and erroneous mounting  
Incorrect mounting may damage the IC. In addition, the presence of foreign particles between the outputs, the output and the power supply, or the output and GND may result in IC destruction.
- 7) IC handling  
Applying mechanical stress to the IC by deflecting or bending the board may cause fluctuations in the electrical characteristics due to piezo resistance effects.
- 8) Board inspection  
Connecting a capacitor to a pin with low impedance may stress the IC. Therefore, discharging the capacitor after every process is recommended. In addition, when attaching and detaching the jig during the inspection phase, ensure that the power is turned off before inspection and removal. Furthermore, please take measures against ESD in the assembly process as well as during transportation and storage.

**Status of this document**

The Japanese version of this document is formal specification. A customer may use this translation version only for a reference to help reading the formal version.

If there are any differences in translation version of this document formal version takes priority.

●Ordering Information

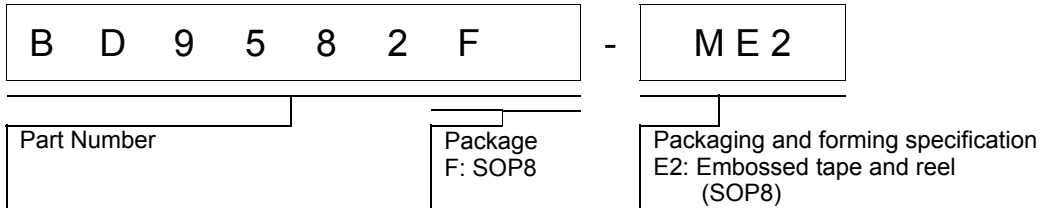

●Physical Dimension Tape and Reel Information

SOP8

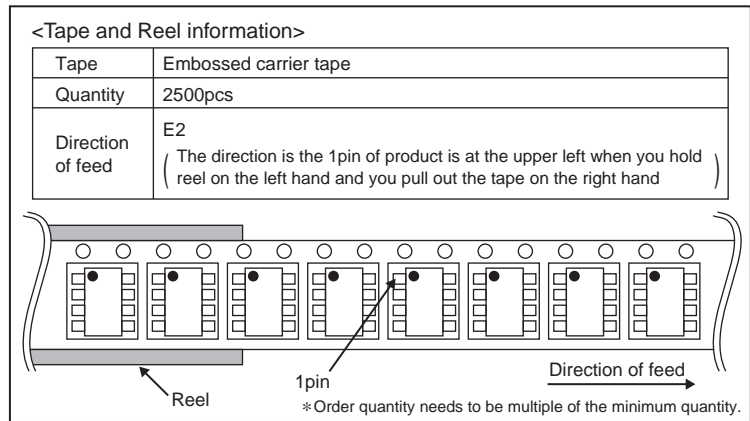
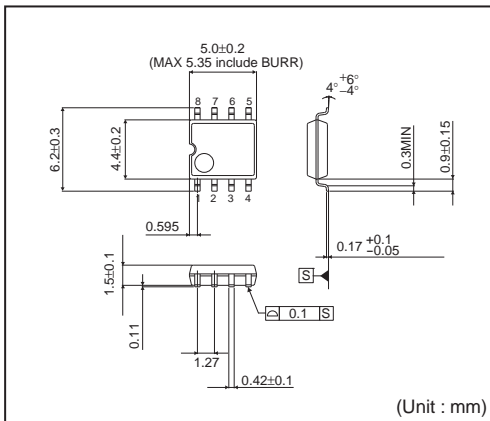

●Marking Diagrams

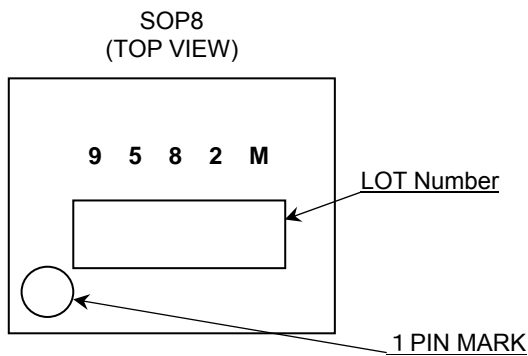

## ●Revision History

Date	Revision	Changes
2012.10.29	001	New Release

# Notice

## ●General Precaution

- 1) Before you use our Products, you are requested to carefully read this document and fully understand its contents. ROHM shall not be in any way responsible or liable for failure, malfunction or accident arising from the use of any ROHM's Products against warning, caution or note contained in this document.
- 2) All information contained in this document is current as of the issuing date and subject to change without any prior notice. Before purchasing or using ROHM's Products, please confirm the latest information with a ROHM sales representative.

## ●Precaution on using ROHM Products

- 1) Our Products are designed and manufactured for application in ordinary electronic equipments (such as AV equipment, OA equipment, telecommunication equipment, home electronic appliances, amusement equipment, etc.). If you intend to use our Products in devices requiring extremely high reliability (such as medical equipment, transport equipment, traffic equipment, aircraft/spacecraft, nuclear power controllers, fuel controllers, car equipment including car accessories, safety devices, etc.) and whose malfunction or failure may cause loss of human life, bodily injury or serious damage to property ("Specific Applications"), please consult with the ROHM sales representative in advance. Unless otherwise agreed in writing by ROHM in advance, ROHM shall not be in any way responsible or liable for any damages, expenses or losses incurred by you or third parties arising from the use of any ROHM's Products for Specific Applications.
- 2) ROHM designs and manufactures its Products subject to strict quality control system. However, semiconductor products can fail or malfunction at a certain rate. Please be sure to implement, at your own responsibilities, adequate safety measures including but not limited to fail-safe design against the physical injury, damage to any property, which a failure or malfunction of our Products may cause. The following are examples of safety measures:
  - [a] Installation of protection circuits or other protective devices to improve system safety
  - [b] Installation of redundant circuits to reduce the impact of single or multiple circuit failure
- 3) Our Products are designed and manufactured for use under standard conditions and not under any special or extraordinary environments or conditions, as exemplified below. Accordingly, ROHM shall not be in any way responsible or liable for any damages, expenses or losses arising from the use of any ROHM's Products under any special or extraordinary environments or conditions. If you intend to use our Products under any special or extraordinary environments or conditions (as exemplified below), your independent verification and confirmation of product performance, reliability, etc. prior to use, must be necessary:
  - [a] Use of our Products in any types of liquid, including water, oils, chemicals, and organic solvents
  - [b] Use of our Products outdoors or in places where the Products are exposed to direct sunlight or dust
  - [c] Use of our Products in places where the Products are exposed to sea wind or corrosive gases, including Cl<sub>2</sub>, H<sub>2</sub>S, NH<sub>3</sub>, SO<sub>2</sub>, and NO<sub>2</sub>
  - [d] Use of our Products in places where the Products are exposed to static electricity or electromagnetic waves
  - [e] Use of our Products in proximity to heat-producing components, plastic cords, or other flammable items
  - [f] Sealing or coating our Products with resin or other coating materials
  - [g] Use of our Products without cleaning residue of flux (even if you use no-clean type fluxes, cleaning residue of flux is recommended); or Washing our Products by using water or water-soluble cleaning agents for cleaning residue after soldering
  - [h] Use of the Products in places subject to dew condensation
- 4) The Products are not subject to radiation-proof design.
- 5) Please verify and confirm characteristics of the final or mounted products in using the Products.
- 6) In particular, if a transient load (a large amount of load applied in a short period of time, such as pulse) is applied, confirmation of performance characteristics after on-board mounting is strongly recommended. Avoid applying power exceeding normal rated power; exceeding the power rating under steady-state loading condition may negatively affect product performance and reliability.
- 7) De-rate Power Dissipation (Pd) depending on Ambient temperature (Ta). When used in sealed area, confirm the actual ambient temperature.
- 8) Confirm that operation temperature is within the specified range described in the product specification.
- 9) ROHM shall not be in any way responsible or liable for failure induced under deviant condition from what is defined in this document.

● **Precaution for Mounting / Circuit board design**

- 1) When a highly active halogenous (chlorine, bromine, etc.) flux is used, the residue of flux may negatively affect product performance and reliability.
- 2) In principle, the reflow soldering method must be used; if flow soldering method is preferred, please consult with the ROHM representative in advance.

For details, please refer to ROHM Mounting specification

● **Precautions Regarding Application Examples and External Circuits**

- 1) If change is made to the constant of an external circuit, please allow a sufficient margin considering variations of the characteristics of the Products and external components, including transient characteristics, as well as static characteristics.
- 2) You agree that application notes, reference designs, and associated data and information contained in this document are presented only as guidance for Products use. Therefore, in case you use such information, you are solely responsible for it and you must exercise your own independent verification and judgment in the use of such information contained in this document. ROHM shall not be in any way responsible or liable for any damages, expenses or losses incurred by you or third parties arising from the use of such information.

● **Precaution for Electrostatic**

This Product is electrostatic sensitive product, which may be damaged due to electrostatic discharge. Please take proper caution in your manufacturing process and storage so that voltage exceeding the Products maximum rating will not be applied to Products. Please take special care under dry condition (e.g. Grounding of human body / equipment / solder iron, isolation from charged objects, setting of Ionizer, friction prevention and temperature / humidity control).

● **Precaution for Storage / Transportation**

- 1) Product performance and soldered connections may deteriorate if the Products are stored in the places where:
  - [a] the Products are exposed to sea winds or corrosive gases, including Cl<sub>2</sub>, H<sub>2</sub>S, NH<sub>3</sub>, SO<sub>2</sub>, and NO<sub>2</sub>
  - [b] the temperature or humidity exceeds those recommended by ROHM
  - [c] the Products are exposed to direct sunshine or condensation
  - [d] the Products are exposed to high Electrostatic
- 2) Even under ROHM recommended storage condition, solderability of products out of recommended storage time period may be degraded. It is strongly recommended to confirm solderability before using Products of which storage time is exceeding the recommended storage time period.
- 3) Store / transport cartons in the correct direction, which is indicated on a carton with a symbol. Otherwise bent leads may occur due to excessive stress applied when dropping of a carton.
- 4) Use Products within the specified time after opening a humidity barrier bag. Baking is required before using Products of which storage time is exceeding the recommended storage time period.

● **Precaution for Product Label**

QR code printed on ROHM Products label is for ROHM's internal use only.

● **Precaution for Disposition**

When disposing Products please dispose them properly using an authorized industry waste company.

● **Precaution for Foreign Exchange and Foreign Trade act**

Since our Products might fall under controlled goods prescribed by the applicable foreign exchange and foreign trade act, please consult with ROHM representative in case of export.

● **Precaution Regarding Intellectual Property Rights**

- 1) All information and data including but not limited to application example contained in this document is for reference only. ROHM does not warrant that foregoing information or data will not infringe any intellectual property rights or any other rights of any third party regarding such information or data. ROHM shall not be in any way responsible or liable for infringement of any intellectual property rights or other damages arising from use of such information or data.:
- 2) No license, expressly or implied, is granted hereby under any intellectual property rights or other rights of ROHM or any third parties with respect to the information contained in this document.

●Other Precaution

- 1) The information contained in this document is provided on an "as is" basis and ROHM does not warrant that all information contained in this document is accurate and/or error-free. ROHM shall not be in any way responsible or liable for any damages, expenses or losses incurred by you or third parties resulting from inaccuracy or errors of or concerning such information.
- 2) This document may not be reprinted or reproduced, in whole or in part, without prior written consent of ROHM.
- 3) The Products may not be disassembled, converted, modified, reproduced or otherwise changed without prior written consent of ROHM.
- 4) In no event shall you use in any way whatsoever the Products and the related technical information contained in the Products or this document for any military purposes, including but not limited to, the development of mass-destruction weapons.
- 5) The proper names of companies or products described in this document are trademarks or registered trademarks of ROHM, its affiliated companies or third parties.