

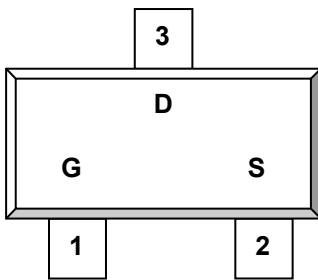

DESCRIPTION

The AMS2300 is the N-Channel logic enhancement mode power field effect transistor is produced using high cell density, DMOS trench technology. This high density process is especially tailored to minimize on-state resistance. These devices are particularly suited for low voltage application such as cellular phone and notebook computer power management and other batter powered circuits, and low in-line power loss are needed in a very small outline surface mount package.

PIN CONFIGURATION SOT-23-3L



1.Gate 2.Source 3.Drain

FEATURE

- 20V/6.0A, $R_{DS(ON)} = 22m\Omega$ (Typ.) @ $V_{GS} = 10V$
- 20V/5.0A, $R_{DS(ON)} = 36m\Omega$ @ $V_{GS} = 4.5V$
- 20V/4.5A, $R_{DS(ON)} = 45m\Omega$ @ $V_{GS} = 2.5V$
- 20V/4.0A, $R_{DS(ON)} = 60m\Omega$ @ $V_{GS} = 1.8V$
- Super high density cell design for extremely low $R_{DS(ON)}$
- Exceptional on-resistance and Maximum DC current capability
- SOT-23-3L package design

PART MARKING SOT-23-3L

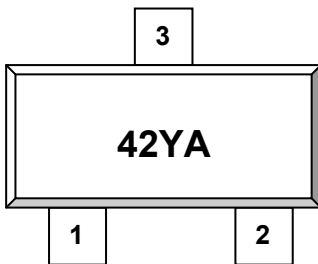

Y: Year Code A: Process Code

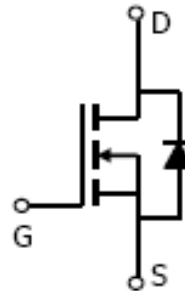

ORDERING INFORMATION

Part Number	Package	Part Marking
AMS2300	SOT-23-3L	42YA

※ Process Code : A ~ Z ; a ~ z



ABSOLUTE MAXIMUM RATINGS (Ta = 25°C Unless otherwise noted)

Parameter	Symbol	Typical	Unit
Drain-Source Voltage	V _{DSS}	20	V
Gate-Source Voltage	V _{GSS}	±12	V
Continuous Drain Current (T _J =150°C)	I _D	T _A =25°C 6.0	A
		T _A =70°C 3.0	
Pulsed Drain Current	I _{DM}	13	A
Continuous Source Current (Diode Conduction)	I _S	1.0	A
Power Dissipation	P _D	T _A =25°C 1.25	W
		T _A =70°C 0.8	
Operation Junction Temperature	T _J	150	°C
Storage Temperature Range	T _{STG}	-55/150	°C
Thermal Resistance-Junction to Ambient	R _{θJA}	140	°C/W



ELECTRICAL CHARACTERISTICS (Ta = 25°C Unless otherwise noted)

Parameter	Symbol	Condition	Min	Typ	Max	Unit
Static						
Drain-Source Breakdown Voltage	$V_{(BR)DSS}$	$V_{GS}=0V, I_D=250\mu A$	20			V
Gate Threshold Voltage	$V_{GS(th)}$	$V_{DS}=V_{GS}, I_D=250\mu A$	0.4		1.0	V
Gate Leakage Current	I_{GSS}	$V_{DS}=0V, V_{GS}=\pm 20V$			± 100	nA
Zero Gate Voltage Drain Current	I_{DSS}	$V_{DS}=20V, V_{GS}=0V$			1	uA
		$V_{DS}=20V, V_{GS}=0V$ $T_J=85^\circ C$			10	
Drain-source On-Resistance	$R_{DS(on)}$	$V_{GS}=10V, I_D=6.0A$ $V_{GS}=4.5V, I_D=5.0A$ $V_{GS}=2.5V, I_D=4.5A$ $V_{GS}=1.8V, I_D=4.0A$		0.022 0.036 0.045 0.060		Ω
Forward Transconductance	g_{fs}	$V_{DS}=15V, I_D=5.0A$		30		S
Diode Forward Voltage	V_{SD}	$I_S=1.7A, V_{GS}=0V$		0.9	1.3	V
Dynamic						
Total Gate Charge	Q_g	$V_{DS}=10V$ $V_{GS}=4.5V$ $I_D=5A$		10	13	nC
Gate-Source Charge	Q_{gs}			1.4		
Gate-Drain Charge	Q_{gd}			2.1		
Input Capacitance	C_{iss}	$V_{DS}=10V$ $V_{GS}=0V$ $F=1MHz$		600		pF
Output Capacitance	C_{oss}			120		
Reverse Transfer Capacitance	C_{rss}			100		
Turn-On Time	$t_{d(on)}$ t_r	$V_{DD}=10V$ $R_L=10\Omega$ $I_D=1A$ $V_{GEN}=4.5V$ $R_G=6\Omega$		15	25	nS
				40	60	
Turn-Off Time	$t_{d(off)}$ t_f			45	65	
				30	40	



TYPICAL CHARACTERISTICS (25°C Unless noted)

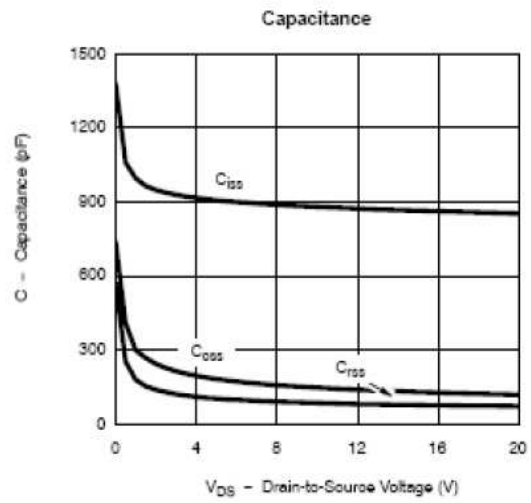
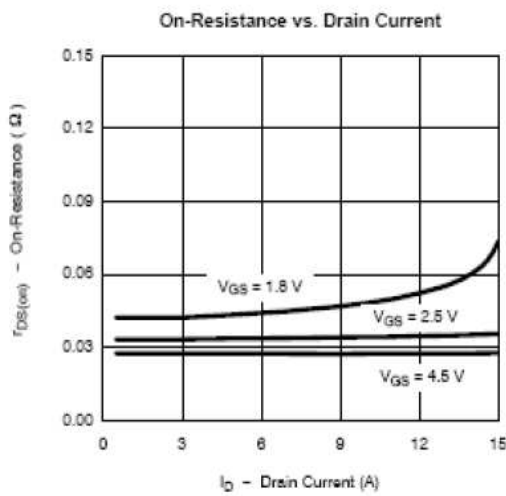
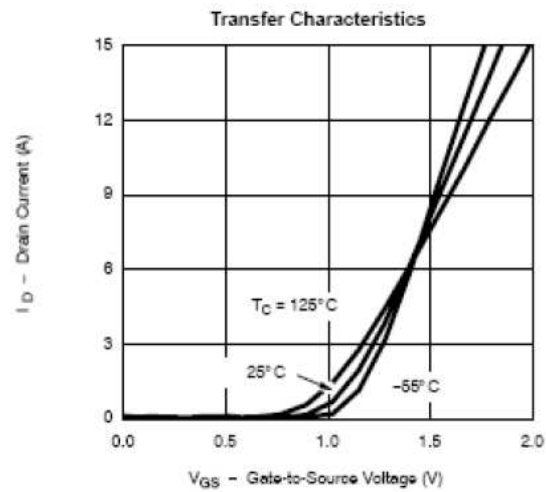
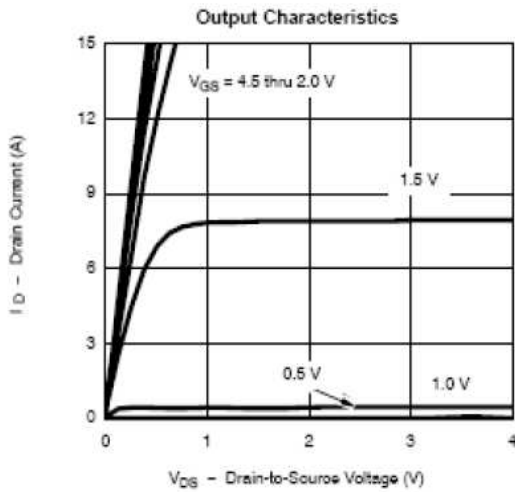



TYPICAL CHARACTERISTICS (25°C Unless noted)

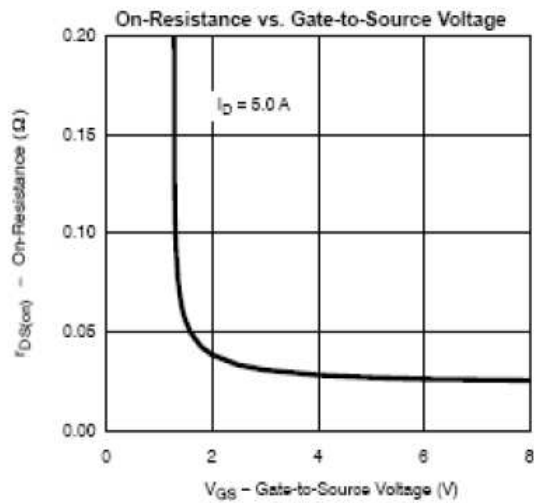
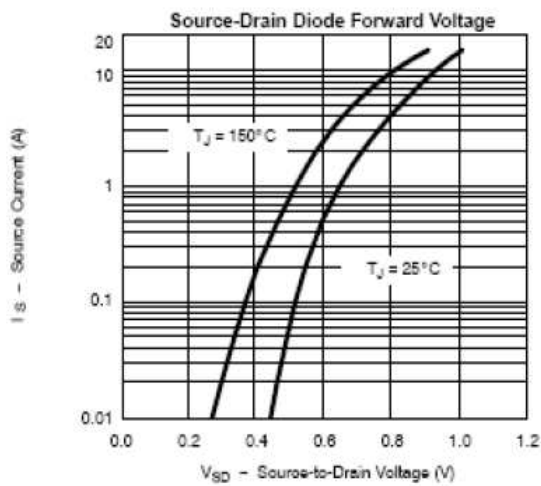
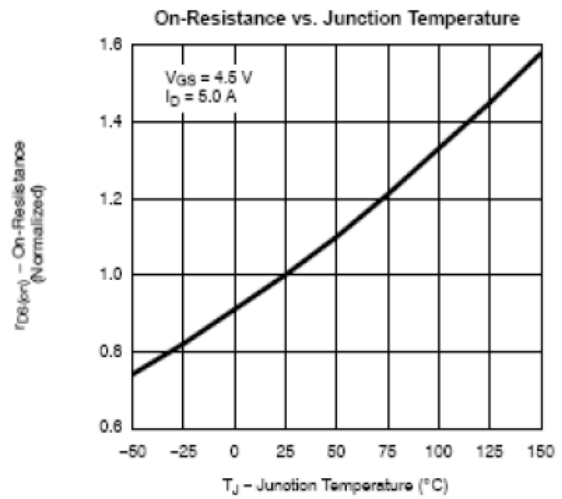
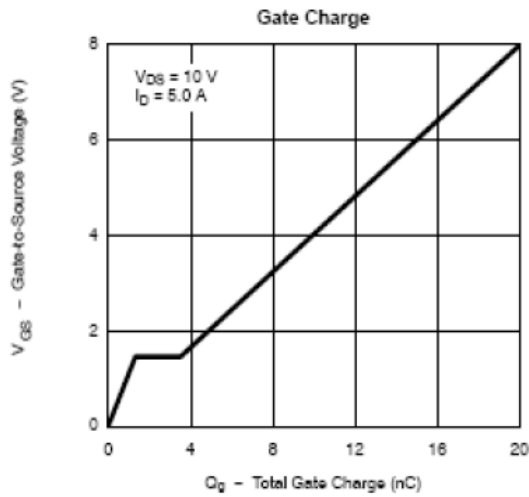



TYPICAL CHARACTERISTICS

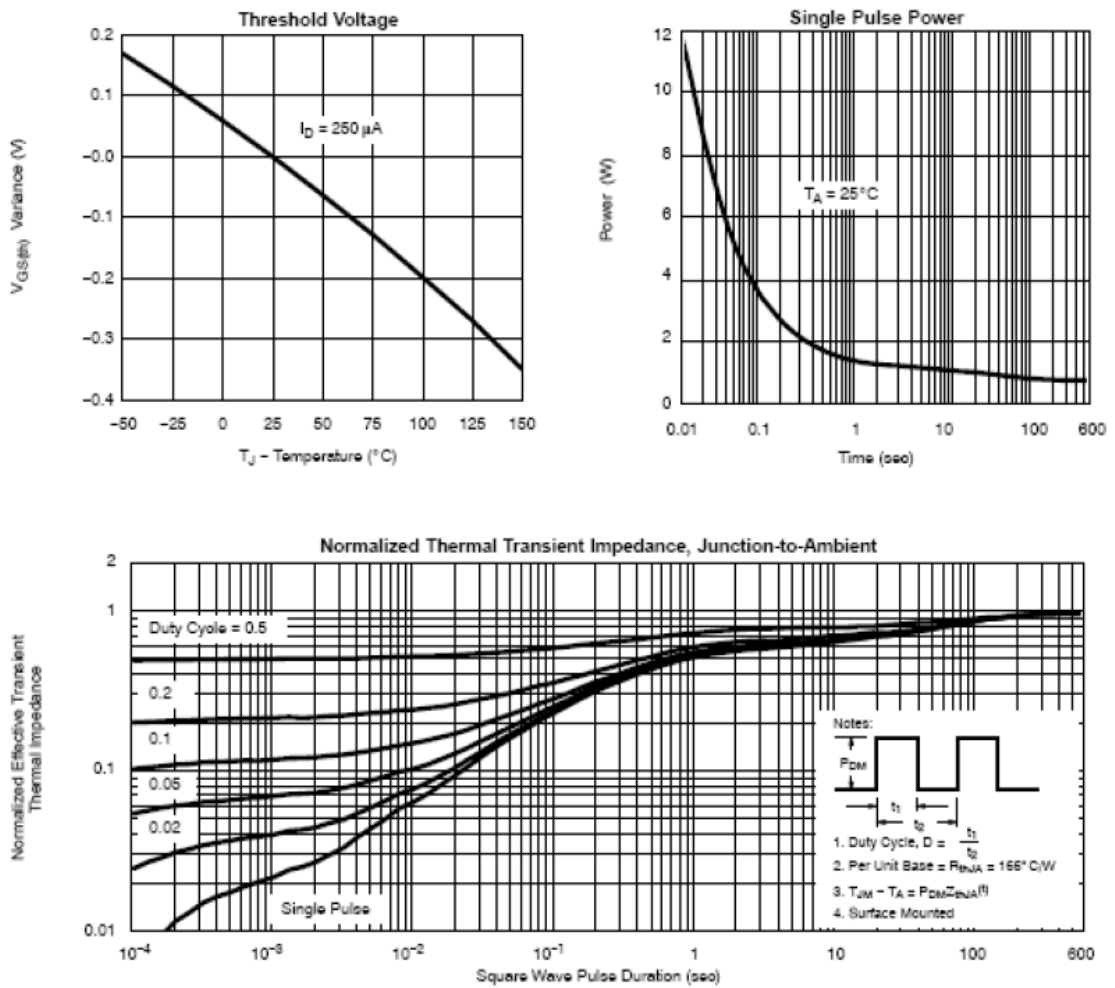



SOT-23-3L PACKAGE OUTLINE

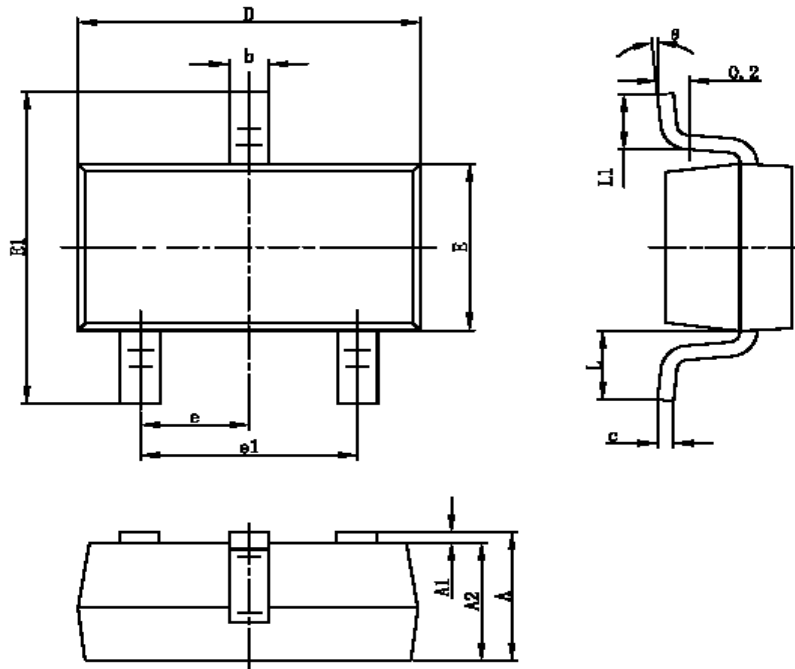

Symbol	Dimensions In Millimeters		Dimensions In Inches	
	Min	Max	Min	Max
A	1.050	1.250	0.041	0.049
A1	0.000	0.100	0.000	0.004
A2	1.050	1.150	0.041	0.045
b	0.300	0.400	0.012	0.016
c	0.100	0.200	0.004	0.008
D	2.820	3.020	0.111	0.119
E	1.500	1.700	0.059	0.067
E1	2.650	2.950	0.104	0.116
e	0.950TYP		0.037TYP	
e1	1.800	2.000	0.071	0.079
L	0.700REF		0.028REF	
L1	0.300	0.600	0.012	0.024
θ	0°	8°	0°	8°