



STD2NC45-1 STQ1NC45R

N-CHANNEL 450V - 4.1Ω - 1.5 A IPAK / TO-92
SuperMESH™ Power MOSFET

TYPE	V _{DSS}	R _{DS(on)}	I _D	P _w
STD2NC45-1	450 V	< 4.5 Ω	1.5 A	30 W
STQ1NC45R	450 V	< 4.5 Ω	0.5 A	3.1 W

- TYPICAL R_{DS(on)} = 4.1 Ω
- EXTREMELY HIGH dv/dt CAPABILITY
- 100% AVALANCHE TESTED
- GATE CHARGE MINIMIZED
- NEW HIGH VOLTAGE BENCHMARK

DESCRIPTION

The SuperMESH™ series is obtained through an extreme optimization of ST's well established strip-based PowerMESH™ layout. In addition to pushing on-resistance significantly down, special care is taken to ensure a very good dv/dt capability for the most demanding applications. Such series complements ST full range of high voltage MOSFETs including revolutionary MDmesh™ products.

APPLICATIONS

- SWITCH MODE LOW POWER SUPPLIES (SMPS)
- LOW POWER, LOW COST CFL (COMPACT FLUORESCENT LAMPS)
- LOW POWER BATTERY CHARGERS

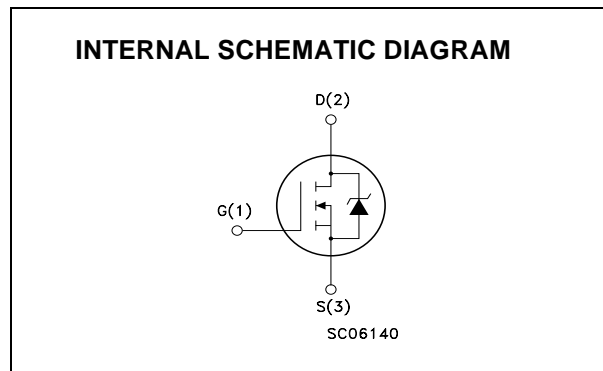
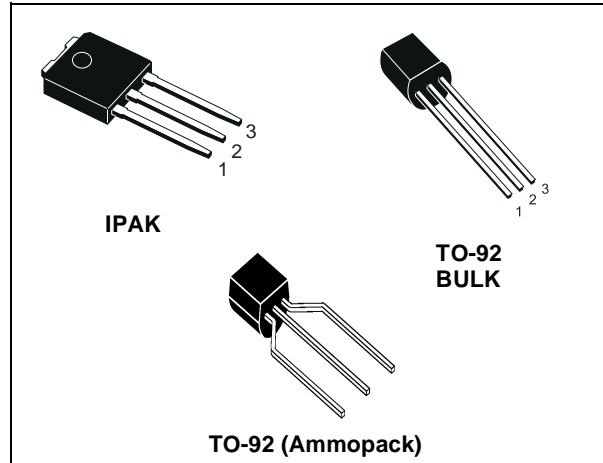

ORDERING INFORMATION

SALES TYPE	MARKING	PACKAGE	PACKAGING
STD2NC45-1	D2NC45	IPAK	TUBE
STQ1NC45R	Q1NC45R	TO-92	BULK
STQ1NC45R-AP	Q1NC45R	TO-92	AMMOPAK

STD2NC45-1, STQ1NC45R

ABSOLUTE MAXIMUM RATINGS

Symbol	Parameter	Value		Unit
		STD2NC45-1	STQ1NC45R	
V_{DS}	Drain-source Voltage ($V_{GS} = 0$)	450		V
V_{DGR}	Drain-gate Voltage ($R_{GS} = 20\text{ k}\Omega$)	450		V
V_{GS}	Gate- source Voltage	± 50		V
I_D	Drain Current (continuous) at $T_C = 25^\circ\text{C}$	1.5	0.5	A
I_D	Drain Current (continuous) at $T_C = 100^\circ\text{C}$	0.95	0.315	A
$I_{DM}(\bullet)$	Drain Current (pulsed)	6	2	A
P_{TOT}	Total Dissipation at $T_C = 25^\circ\text{C}$	30	3.1	W
	Derating Factor	0.24	0.025	W/ $^\circ\text{C}$
dv/dt (1)	Peak Diode Recovery voltage slope	3		V/ns
T_j	Operating Junction Temperature	-65 to 150		$^\circ\text{C}$
T_{stg}	Storage Temperature	-65 to 150		$^\circ\text{C}$

(●) Pulse width limited by safe operating area

(1) $I_{SD} \leq 0.5\text{A}$, $di/dt \leq 100\text{A}/\mu\text{s}$, $V_{DD} \leq V_{(BR)DSS}$, $T_j \leq T_{JMAX}$.

THERMAL DATA

		IPAK	TO-92	
Rthj-case	Thermal Resistance Junction-case Max	4.1		$^\circ\text{C}/\text{W}$
Rthj-amb	Thermal Resistance Junction-ambient Max	100	120	$^\circ\text{C}/\text{W}$
Rthj-lead	Thermal Resistance Junction-lead Max		40	$^\circ\text{C}/\text{W}$
T_l	Maximum Lead Temperature For Soldering Purpose	275	260	$^\circ\text{C}$

AVALANCHE CHARACTERISTICS

Symbol	Parameter	Max Value		Unit
		IPAK	TO-92	
I_{AR}	Avalanche Current, Repetitive or Not-Repetitive (pulse width limited by T_j max)	1.5		A
E_{AS}	Single Pulse Avalanche Energy (starting $T_j = 25^\circ\text{C}$, $I_D = I_{AR}$, $V_{DD} = 50\text{ V}$)	25		mJ

ELECTRICAL CHARACTERISTICS (TCASE =25°C UNLESS OTHERWISE SPECIFIED)
ON/OFF

Symbol	Parameter	Test Conditions	Min.	Typ.	Max.	Unit
$V_{(BR)DSS}$	Drain-source Breakdown Voltage	$I_D = 250 \mu A, V_{GS} = 0$	450			V
I_{DSS}	Zero Gate Voltage Drain Current ($V_{GS} = 0$)	$V_{DS} = \text{Max Rating}$ $V_{DS} = \text{Max Rating}, T_C = 125^\circ C$			1 50	μA μA
I_{GSS}	Gate-body Leakage Current ($V_{DS} = 0$)	$V_{GS} = \pm 30V$			± 100	nA
$V_{GS(th)}$	Gate Threshold Voltage	$V_{DS} = V_{GS}, I_D = 250\mu A$	2.3	3	3.7	V
$R_{DS(on)}$	Static Drain-source On Resistance	$V_{GS} = 10V, I_D = 0.5 A$		4.1	4.5	Ω

DYNAMIC

Symbol	Parameter	Test Conditions	Min.	Typ.	Max.	Unit
$g_{fs} (1)$	Forward Transconductance	$V_{DS} > I_{D(on)} \times R_{DS(on)max},$ $I_D = 0.5 A$		1.1		S
C_{iss} C_{oss} C_{rss}	Input Capacitance Output Capacitance Reverse Transfer Capacitance	$V_{DS} = 25V, f = 1 \text{ MHz}, V_{GS} = 0$		160 27.5 4.7		pF pF pF

SWITCHING ON

Symbol	Parameter	Test Conditions	Min.	Typ.	Max.	Unit
$t_{d(on)}$ t_r	Turn-on Delay Time Rise Time	$V_{DD} = 225 V, I_D = 0.5 A$ $R_G = 4.7\Omega, V_{GS} = 10 V$ (Resistive Load see, Figure 3)		6.7 4		ns ns
Q_g Q_{gs} Q_{gd}	Total Gate Charge Gate-Source Charge Gate-Drain Charge	$V_{DD} = 360V, I_D = 1.5 A,$ $V_{GS} = 10V, R_G = 4.7\Omega$		7 1.3 3.2	10	nC nC nC

SWITCHING OFF

Symbol	Parameter	Test Conditions	Min.	Typ.	Max.	Unit
$t_{r(Voff)}$ t_f t_c	Off-voltage Rise Time Fall Time Cross-over Time	$V_{DD} = 360V, I_D = 1.5 A,$ $R_G = 4.7\Omega, V_{GS} = 10V$ (Inductive Load see, Figure 5)		8.5 12 18		ns ns ns

SOURCE DRAIN DIODE

Symbol	Parameter	Test Conditions	Min.	Typ.	Max.	Unit
I_{SD} $I_{SDM} (2)$	Source-drain Current Source-drain Current (pulsed)				1.5 6.0	A A
$V_{SD} (1)$	Forward On Voltage	$I_{SD} = 1.5 A, V_{GS} = 0$			1.6	V
t_{rr} Q_{rr} I_{RRM}	Reverse Recovery Time Reverse Recovery Charge Reverse Recovery Current	$I_{SD} = 1.5 A, di/dt = 100A/\mu s$ $V_{DD} = 100V, T_j = 150^\circ C$ (see test circuit, Figure 5)		225 530 4.7		ns μC A

Note: 1. Pulsed: Pulse duration = 300 μs , duty cycle 1.5 %.
2. Pulse width limited by safe operating area.

Safe Operating Area For IPAK

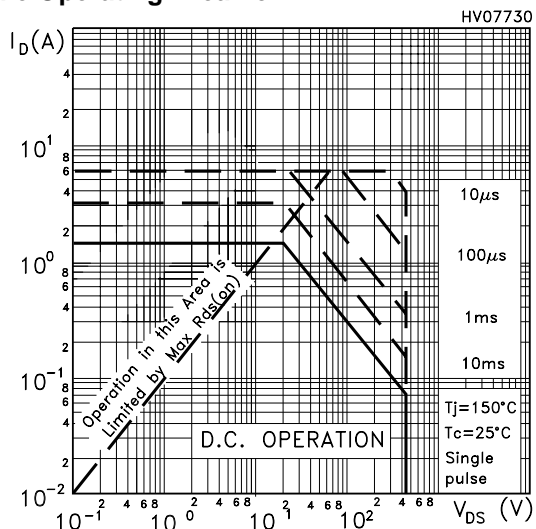

Thermal Impedance For IPAK

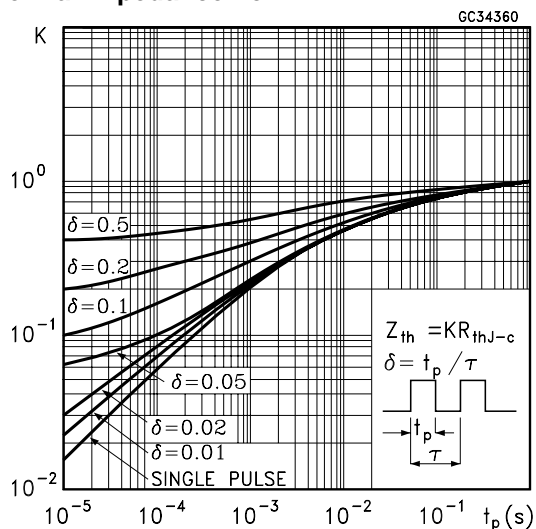

Safe Operating Area For TO-92

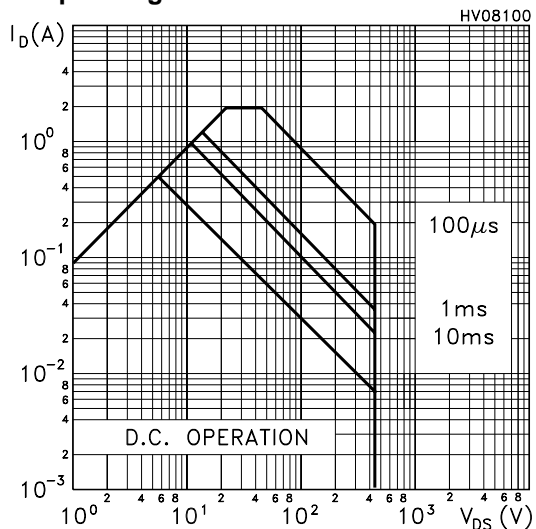

Thermal Impedance For TO-92

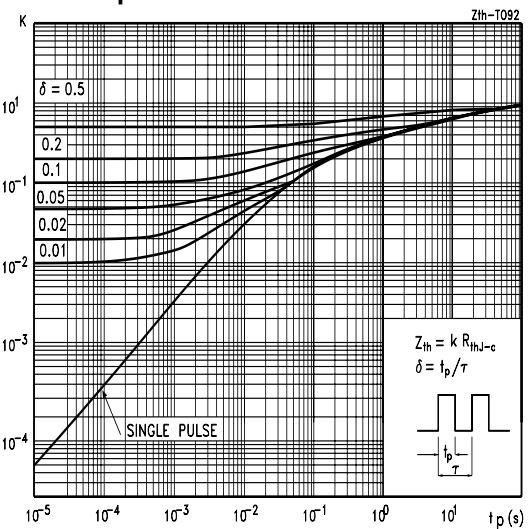

Output Characteristics

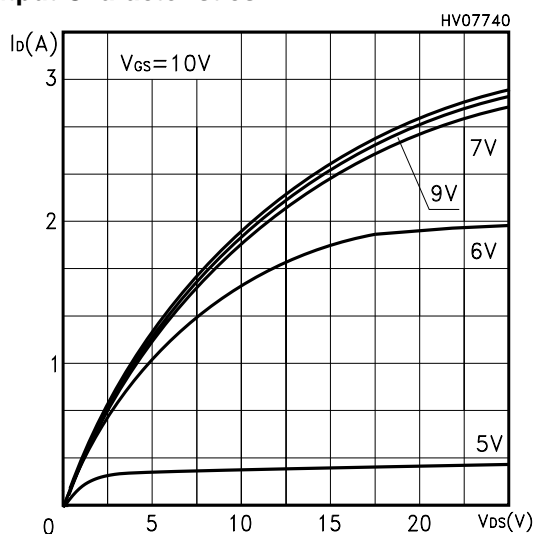

Transfer Characteristics

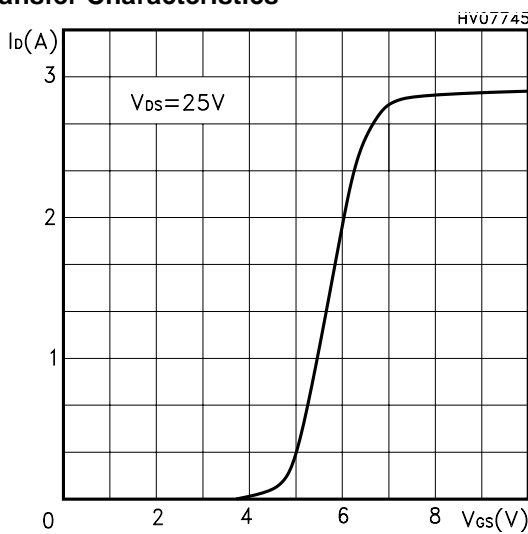

Transconductance

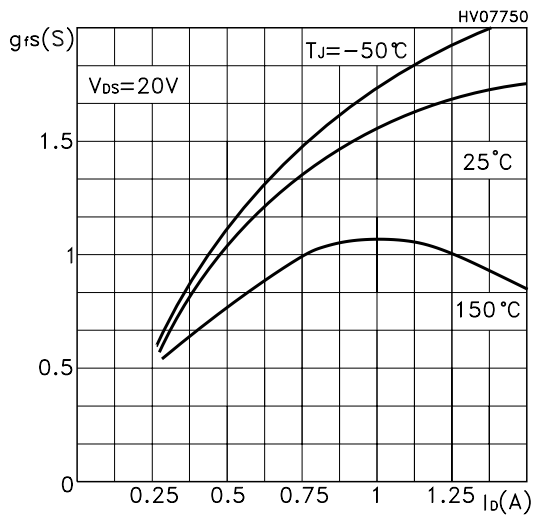

Static Drain-source On Resistance

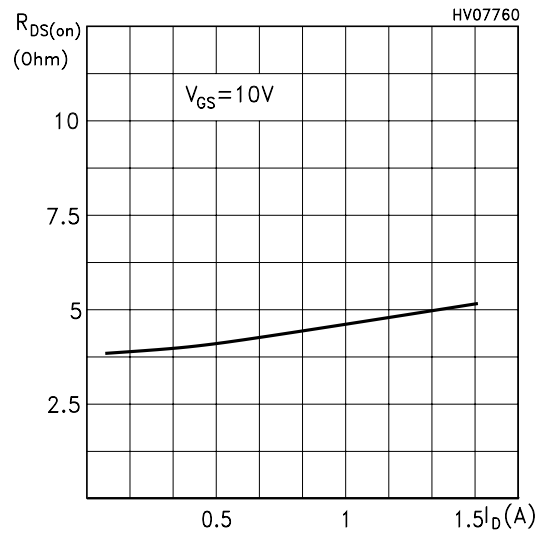

Gate Charge vs Gate-source Voltage

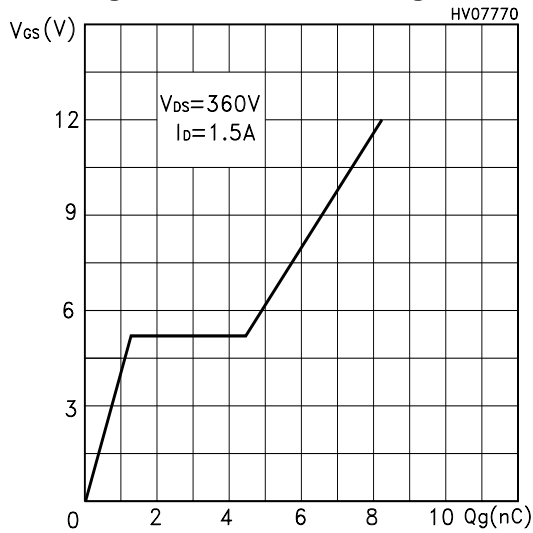

Capacitance Variations

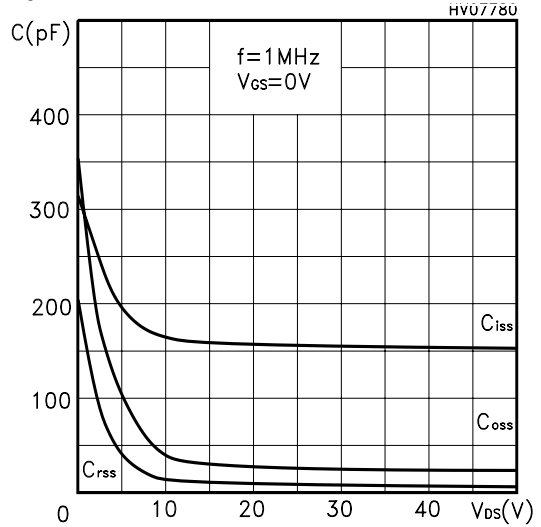

Normalized Gate Threshold Voltage vs Temp.

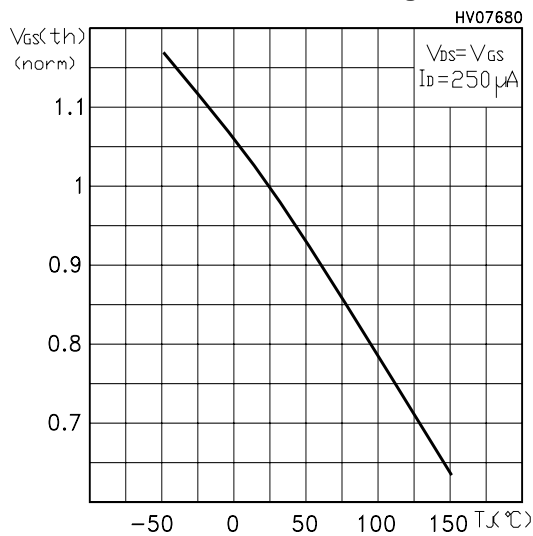

Normalized On Resistance vs Temperature

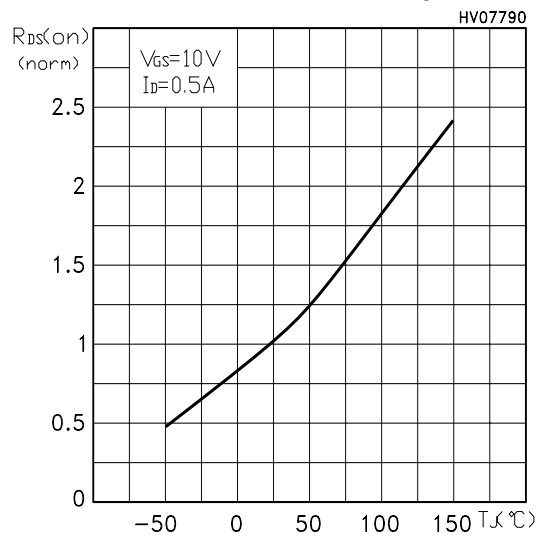

Source-drain Diode Forward Characteristics

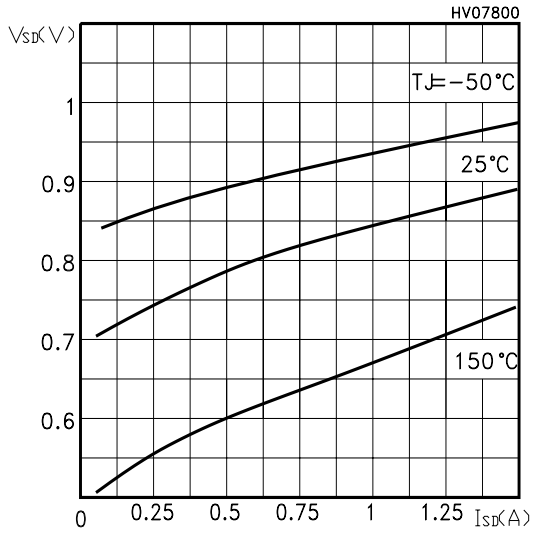

Max Id Current vs Tc

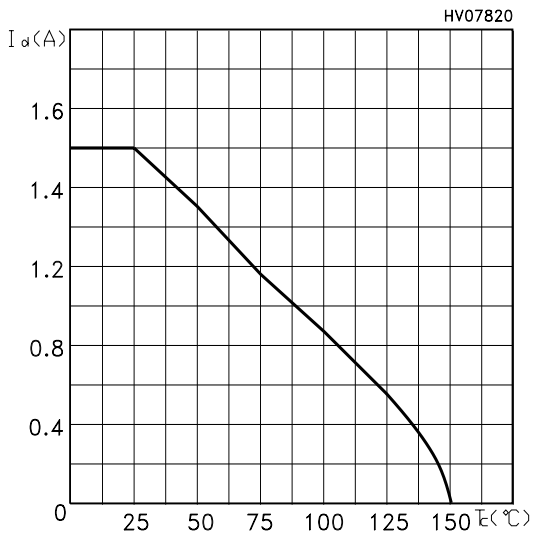

Normalized BVDSS vs Temperature

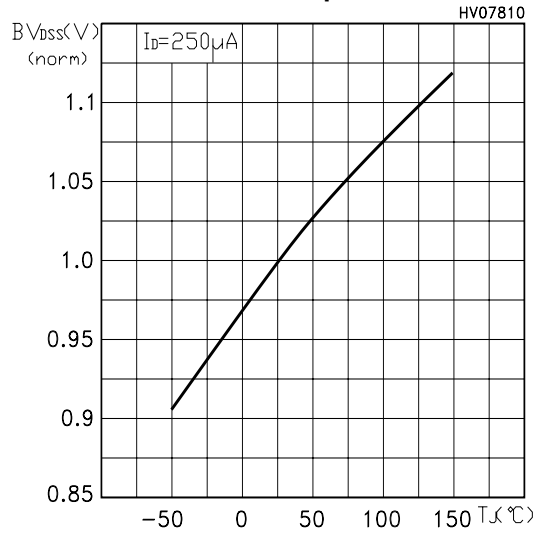

Maximum Avalanche Energy vs Temperature

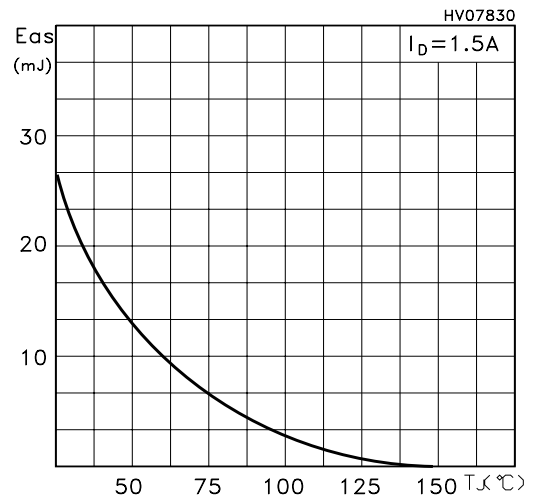

Fig. 1: Unclamped Inductive Load Test Circuit



Fig. 2: Unclamped Inductive Waveform



Fig. 3: Switching Times Test Circuit For Resistive Load



Fig. 4: Gate Charge test Circuit

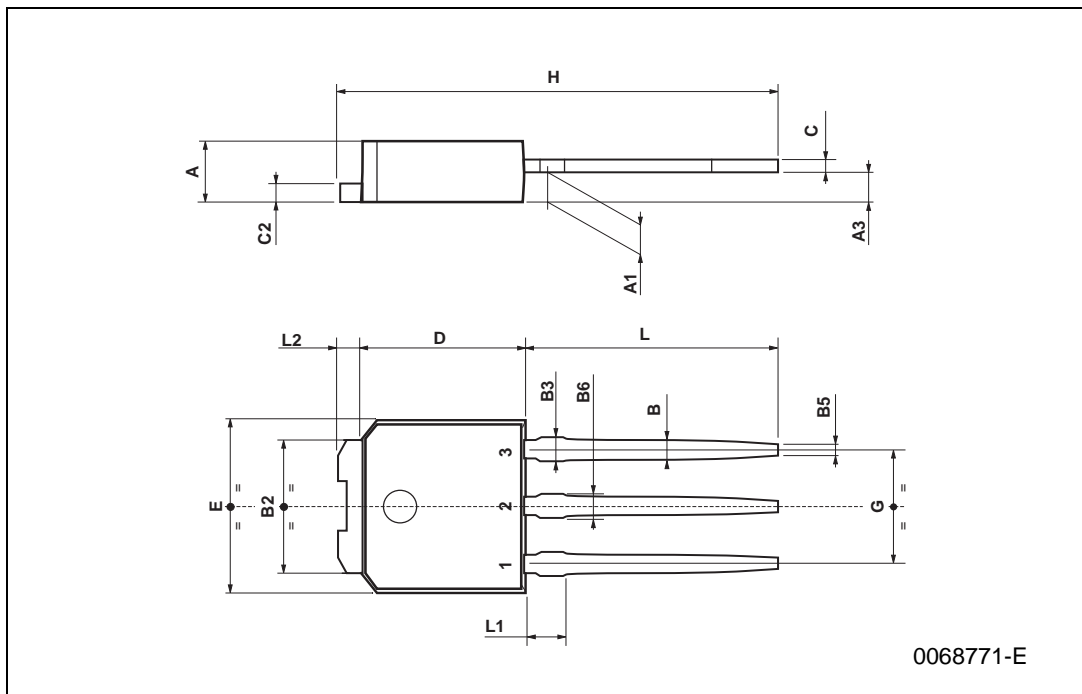

Fig. 5: Test Circuit For Inductive Load Switching And Diode Recovery Times



TO-251 (IPAK) MECHANICAL DATA

DIM.	mm			inch		
	MIN.	TYP.	MAX.	MIN.	TYP.	MAX.
A	2.2		2.4	0.086		0.094
A1	0.9		1.1	0.035		0.043
A3	0.7		1.3	0.027		0.051
B	0.64		0.9	0.025		0.031
B2	5.2		5.4	0.204		0.212
B3			0.85			0.033
B5		0.3			0.012	
B6			0.95			0.037
C	0.45		0.6	0.017		0.023
C2	0.48		0.6	0.019		0.023
D	6		6.2	0.236		0.244
E	6.4		6.6	0.252		0.260
G	4.4		4.6	0.173		0.181
H	15.9		16.3	0.626		0.641
L	9		9.4	0.354		0.370
L1	0.8		1.2	0.031		0.047
L2		0.8	1		0.031	0.039



TO-92 MECHANICAL DATA

DIM.	mm			inch		
	MIN.	TYP.	MAX.	MIN.	TYP.	MAX.
A	4.58		5.33	0.180		0.210
B	4.45		5.2	0.175		0.204
C	3.2		4.2	0.126		0.165
D	12.7			0.500		
E		1.27			0.050	
F	0.4		0.51	0.016		0.020
G	0.35			0.14		

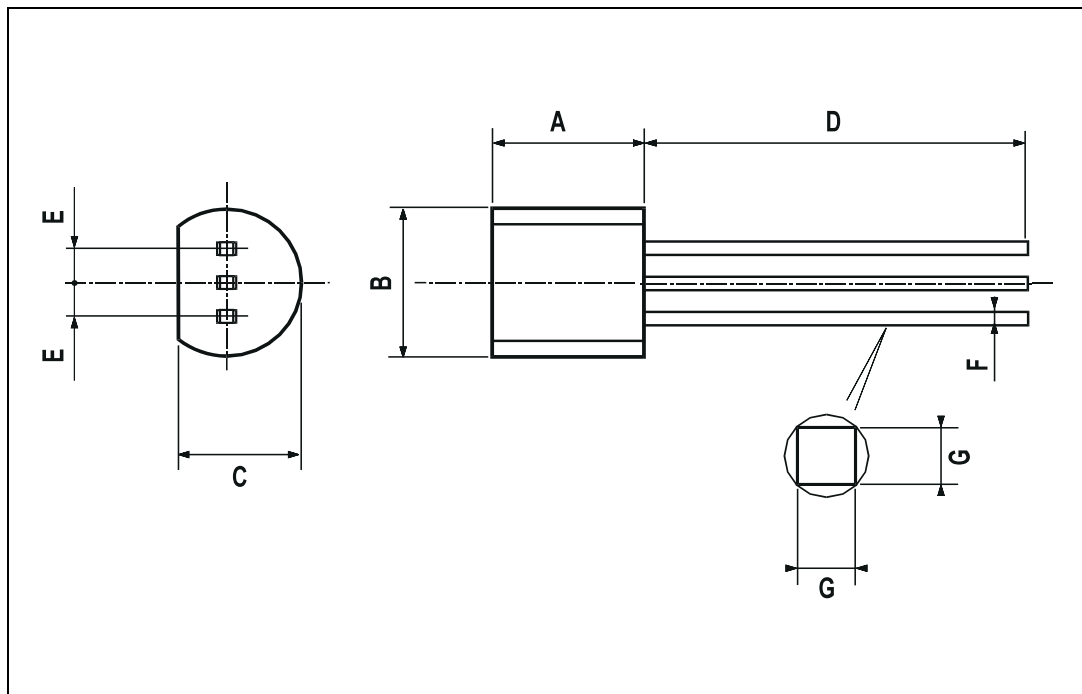

TO-92 AMMOPACK

DIM.	mm.			inch		
	MIN.	TYP	MAX.	MIN.	TYP.	MAX.
A1			4.8			0.19
T			3.8			0.15
T1			1.6			0.06
T2			2.3			0.09
d			0.48			0.02
P0	12.5	12.7	12.9	0.49	0.5	0.51
P2	5.65	6.35	7.05	0.22	0.25	0.27
F1, F2	2.44	2.54	2.94	0.09	0.1	0.11
delta H	-2		2	-0.08		0.08
W	17.5	18	19	0.69	0.71	0.74
W0	5.7	6	6.3	0.22	0.23	0.24
W1	8.5	9	9.25	0.33	0.35	0.36
W2			0.5			0.02
H	18.5		20.5	0.72		0.80
H0	15.5	16	16.5	0.61	0.63	0.65
H1			25			0.98
D0	3.8	4	4.2	0.15	0.157	0.16
t			0.9			0.035
L			11			0.43
l1	3			0.11		
delta P	-1		1	-0.04		0.04

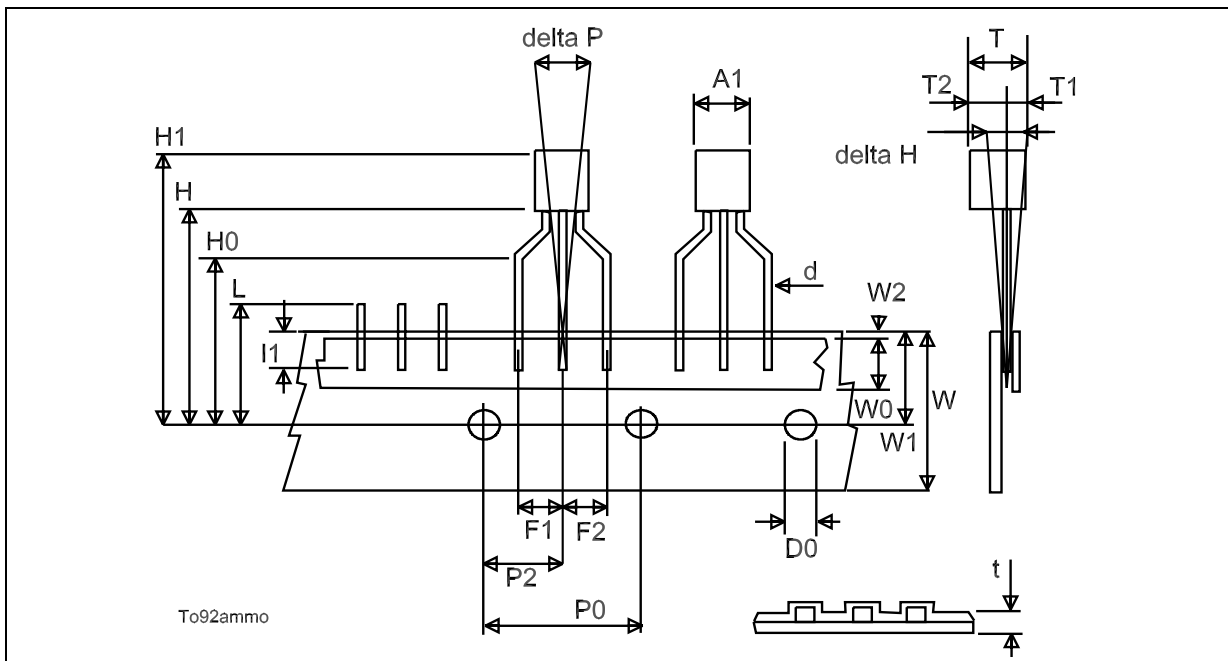

Information furnished is believed to be accurate and reliable. However, STMicroelectronics assumes no responsibility for the consequences of use of such information nor for any infringement of patents or other rights of third parties which may result from its use. No license is granted by implication or otherwise under any patent or patent rights of STMicroelectronics. Specifications mentioned in this publication are subject to change without notice. This publication supersedes and replaces all information previously supplied. STMicroelectronics products are not authorized for use as critical components in life support devices or systems without express written approval of STMicroelectronics.

© The ST logo is a registered trademark of STMicroelectronics

© 2002 STMicroelectronics - Printed in Italy - All Rights Reserved
STMicroelectronics GROUP OF COMPANIES

Australia - Brazil - Canada - China - Finland - France - Germany - Hong Kong - India - Israel - Italy - Japan - Malaysia - Malta - Morocco
Singapore - Spain - Sweden - Switzerland - United Kingdom - United States.

© <http://www.st.com>