

FSUSB22

Low Voltage Ultra Low Power USB High Speed (480 Mbps) Dual DPDT Switch

General Description

FSUSB22 is a low power high bandwidth analog switch specially designed for applications of the switching of high speed USB 2.0 signals in handset and consumer applications such as cell phone, digital camera, and notebook with hubs or controllers of limited USB I/O. The wide bandwidth (750MHz) of this switch allows signals to pass with minimum edge and phase distortion. Superior channel-to-channel crosstalk results in minimal interference. It is compatible with high speed USB2.0 standard.

Features

- -40dB OFF Isolation at 250MHz
- -40dB non-adjacent channel crosstalk at 250MHz
- 4.5Ω typical On Resistance (R_{ON})
- -3dB bandwidth: 750MHz
- Low power consumption (1uA max)
- Control input: TTL compatible
- Bidirectional operation
- USB high speed and full speed signaling capability

Applications

- Cell phone, PDA, digital camera, and notebook

Ordering Code:

Order Number	Package Number	Package Description
FSUSB22BQX	MLP016E	Pb-Free 16-Terminal Depopulated Quad Very-Thin Flat Pack No Leads (DQFN), JEDEC MO-241, 2.5 x 3.5mm
FSUSB22QSC (Preliminary)	MQA16	16-Lead Quarter Size Outline Package (QSOP), JEDEC MO-137, 0.150" Wide
FSUSB22MTC	MTC16	16-Lead Thin Shrink Small Outline Package (TSSOP), JEDEC MO-153, 4.4mm Wide

Devices also available in Tape and Reel. Specify by appending suffix letter "X" to the ordering code.
Pb-Free package per JEDEC J-STD-020B.

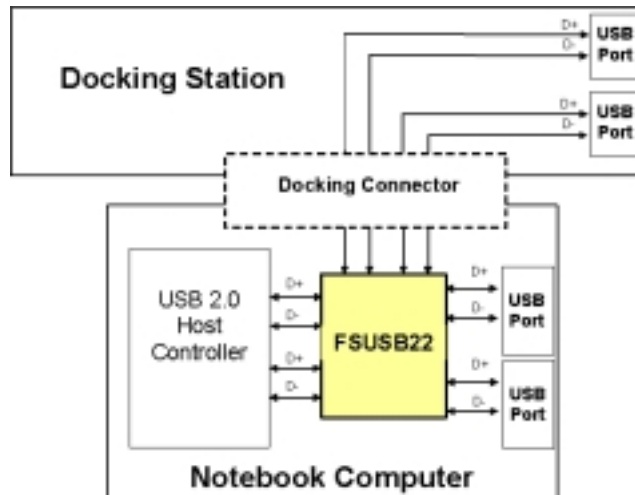

Analog Symbol

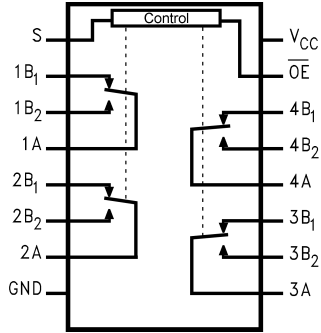

Connection Diagrams

Pin Assignments for QSOP and TSSOP

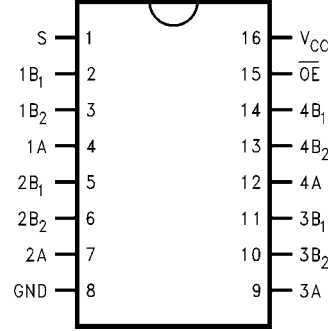

Pin Descriptions

Pin Name	Description
\overline{OE}	Bus Switch Enable
S	Select Input
A	Bus A
B ₁ -B ₂	Bus B

Pad Assignments for DQFN

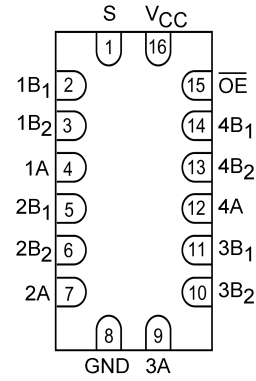

Truth Table

s	\overline{OE}	Function
X	H	Disconnect
L	L	A = B ₁
H	L	A = B ₂

Absolute Maximum Ratings (Note 1)

Supply Voltage (V_{CC})	-0.5V to +4.6V
DC Switch Voltage (V_S)	-0.5V to $V_{CC} + 0.05V$
DC Input Voltage (V_{IN}) (Note 2)	-0.5V to +4.6V
DC Input Diode Current (I_{IK}) $V_{IN} < 0V$	-50 mA
DC Output (I_{OUT}) Sink Current	128 mA
DC V_{CC}/GND Current (I_{CC}/I_{GND})	± 100 mA
Storage Temperature Range (T_{STG})	-65°C to +150 °C
ESD Human Body Model	4kV

Recommended Operating Conditions (Note 3)

Power Supply Operating (V_{CC})	3.0V to 3.6V
Input Voltage (V_{IN})	0V to V_{CC}
Output Voltage (V_{OUT})	0V to V_{CC}
Input Rise and Fall Time (t_r, t_f)	
Switch Control Input	0 ns/V to 5 ns/V
Switch I/O	0 ns/V to DC
Free Air Operating Temperature (T_A)	-40 °C to +85 °C

Note 1: The Absolute Maximum Ratings are those values beyond which the safety of the device cannot be guaranteed. The device should not be operated at these limits. The parametric values defined in the Electrical Characteristics tables are not guaranteed at the absolute maximum rating. The Recommended Operating Conditions tables will define the conditions for actual device operation.

Note 2: The input and output negative voltage ratings may be exceeded if the input and output diode current ratings are observed.

Note 3: Unused control inputs must be held HIGH or LOW. They may not float.

DC Electrical Characteristics

Symbol	Parameter	V_{CC} (V)	$T_A = -40\text{ }^\circ\text{C to } +85\text{ }^\circ\text{C}$			Units	Conditions
			Min	Typ (Note 4)	Max		
V_{IK}	Clamp Diode Voltage	3.0			-1.2	V	$I_{IN} = -18\text{ mA}$
V_{IH}	HIGH Level Input Voltage	3.0 - 3.6	2.0			V	
V_{IL}	LOW Level Input Voltage	3.0 - 3.6			0.8	V	
I_I	Input Leakage Current	3.6			± 1.0	μA	$0 \leq V_{IN} \leq 3.6V$
I_{OFF}	OFF-STATE Leakage Current	3.6			± 1.0	μA	$0 \leq A, B \leq V_{CC}$
R_{ON}	Switch On Resistance (Note 5)	3.0		5.0	7.0	Ω	$V_{IN} = 0.8V$ $I_{ON} = 8\text{ mA}$
		3.0		4.5	6.5	Ω	$V_{IN} = 3.0V$ $I_{ON} = 8\text{ mA}$
ΔR_{ON}	Delta R_{ON}	3.0		0.3		Ω	$V_{IN} = 0.8V, V_{IN} = 0V - 1.5V, I_{ON} = 8\text{ mA}$
$R_{FLAT(ON)}$	On Resistance Flatness (Note 6)	3.0		1.0	1.3	Ω	$I_{OUT} = 8\text{ mA}$
I_{CC}	Quiescent Supply Current	3.6			1.0	μA	$V_{IN} = V_{CC}$ or GND, $I_{OUT} = 0$

Note 4: Typical values are at $V_{CC} = 3.0V$ and $T_A = +25^\circ\text{C}$

Note 5: Measured by the voltage drop between A and B pins at the indicated current through the switch. On Resistance is determined by the lower of the voltages on the two (A or B) pins.

Note 6: Flatness is defined as the difference between the maximum and minimum value On Resistance over the specified range of conditions.

AC Electrical Characteristics

Symbol	Parameter	V _{CC} (V)	T _A = -40°C to +85°C			Units	Conditions	Figure Number
			Min	Typ (Note 7)	Max			
t _{ON}	Turn ON Time S-to-Bus B	3.0 to 3.6		4.5	6.0	ns		Figures 5, 6
t _{OFF}	Turn OFF Time S-to-Bus B	3.0 to 3.6		2.5	4.0	ns		Figures 5, 6
t _{PD}	Propagation Delay	3.0 to 3.6		0.25		ns	C _L = 10 pF	Figure 10
O _{IRR}	Non-Adjacent OFF-Isolation	3.0 to 3.6		-55.0		dB	f = 10MHz, R _L = 50Ω	Figure 7
X _{TALK}	Non-Adjacent Channel Crosstalk	3.0 to 3.6		-75.0		dB	R _L = 50Ω, f = 10MHz	Figure 8
BW	-3dB Bandwidth	3.0 to 3.6		750		MHz	R _L = 50Ω	Figure 9

Note 7: Typical values are at V_{CC} = 3.3V and T_A = +25°C

USB Related AC Electrical Characteristics (Note 8)

Symbol	Parameter	V _{CC} (V)	T _A = -40°C to +85°C			Units	Conditions	Figure Number
			Min	Typ	Max			
t _{SK(O)}	Channel-to-Channel Skew	3.0 to 3.6		0.051		ns	C _L = 10 pF	Figures 10, 11
t _{SK(P)}	Skew of Opposite Transition of the Same Output	3.0 to 3.6		0.020		ns	C _L = 10 pF	Figures 10, 11
T _J	Total Jitter	3.0 to 3.6		0.210		ns	R _L = 50Ω, C _L = 10 pF t _R = t _F = 750ps at 480 Mbps	

Note 8: Typical values are at V_{CC} = 3.3V and T_A = +25°C

Capacitance (Note 9)

Symbol	Parameter	V _{CC} (V)	T _A = -40°C to +85°C		Units	Conditions
			Min	Typ		
C _{IN}	Control Pin Input Capacitance			2.5	pF	V _{CC} = 0V
C _{ON}	A/B ON Capacitance			12.0	pF	V _{CC} = 3.3V, OE = 0V
C _{OFF}	Port B OFF Capacitance			4.5	pF	V _{CC} and OE = 3.3V

Note 9: Typical values are at V_{CC} = 3.3V and T_A = +25°C

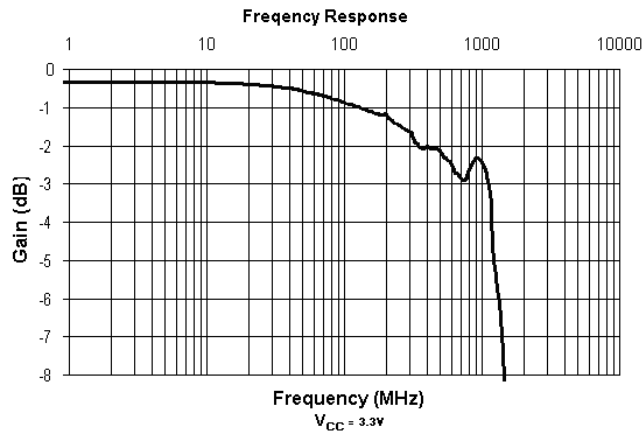

FIGURE 1. Gain vs. Frequency

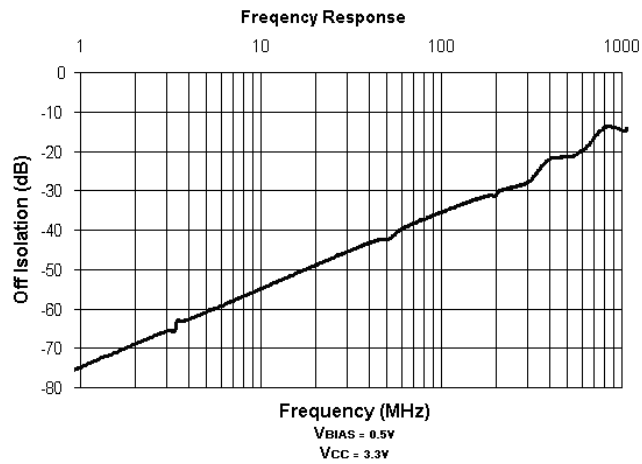

FIGURE 2. OFF Isolation

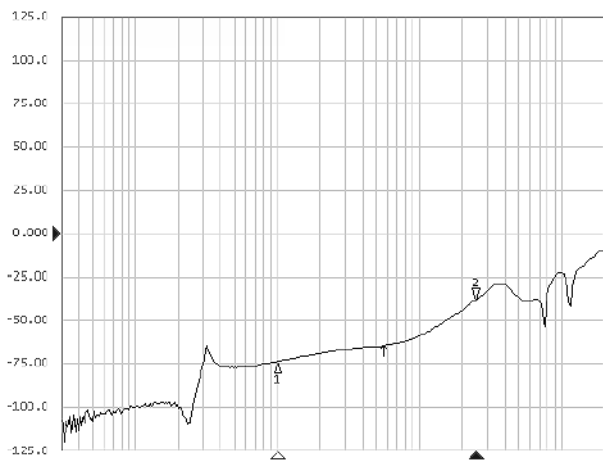

FIGURE 3. Crosstalk

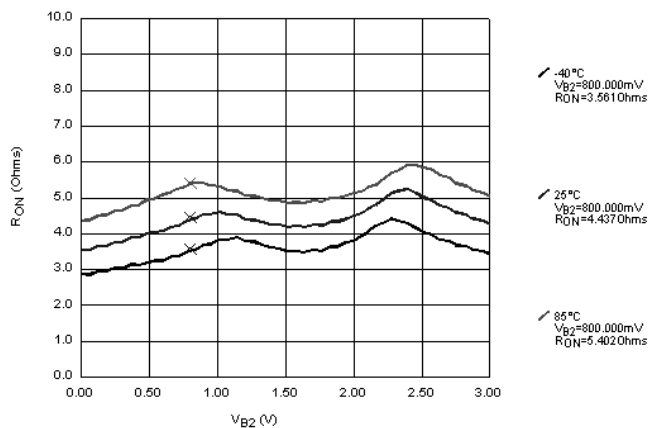
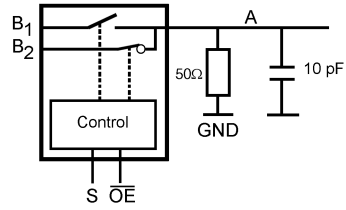

FIGURE 4. R_{ON}

AC Loading and Waveforms



Note: Input driven by 50Ω source terminated in 50Ω
Note: C_L includes load and stray capacitance
Note: Input PRR = 1.0 MHz, t_W = 500 ns

FIGURE 5. AC Test Circuit

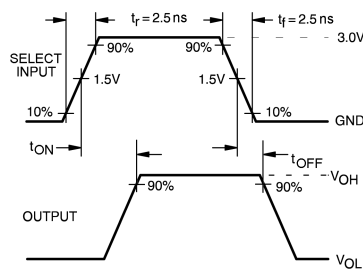

FIGURE 6. AC Waveforms

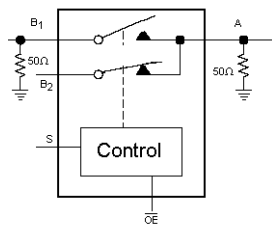

FIGURE 7. OFF Isolation Test

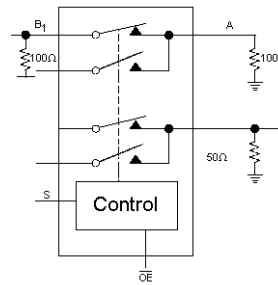

FIGURE 8. Crosstalk Test

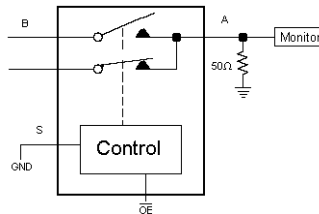

FIGURE 9. Bandwidth Test

AC Loading and Waveforms (Continued)

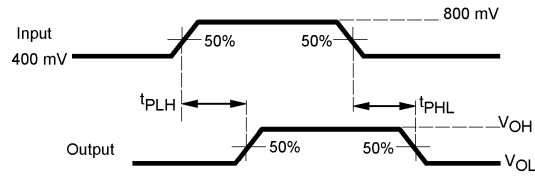
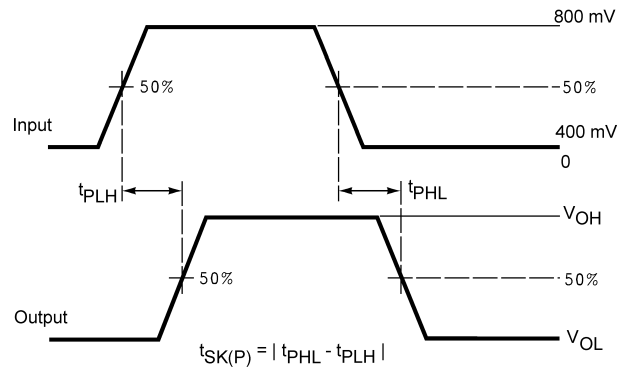
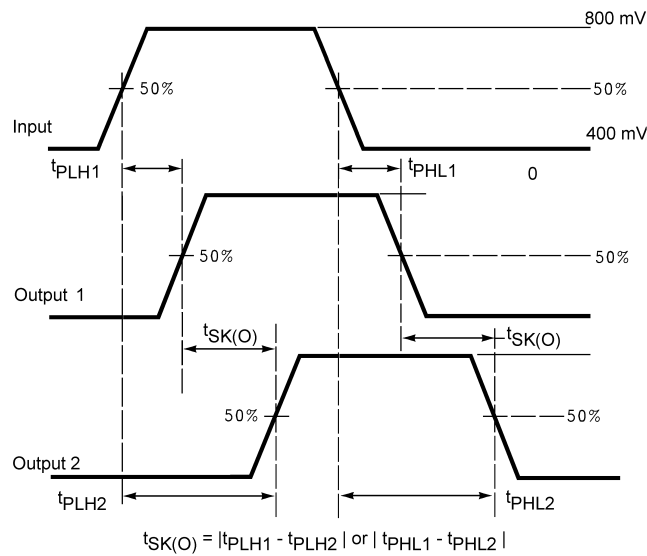

FIGURE 10. Propagation Delay



Pulse Skew $t_{SK(P)}$



Output Skew $t_{SK(O)}$

FIGURE 11. Skew Test

Tape and Reel Specification

Tape Format for DQFN

Package Designator	Tape Section	Number Cavities	Cavity Status	Cover Tape Status
BQX	Leader (Start End)	125 (typ)	Empty	Sealed
	Carrier	2500/3000	Filled	Sealed
	Trailer (Hub End)	75 (typ)	Empty	Sealed

TAPE DIMENSIONS inches (millimeters)

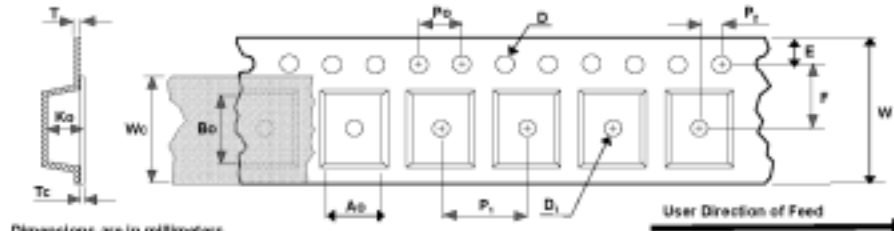

Dimensions are in millimeters

Package	Ao +/-0.10	Bo +/-0.10	D +/-0.05	D1 min	E +/-0.1	F +/-0.1	Ko +/-0.1	P1 TYP	P2 TYP	P3 +/-0.05	T TYP	Tc +/-0.005	W +/-0.3	Wc TYP
2 x 2	2.30	2.30	1.55	1.0	1.75	3.5	1.0	8	4	2.0	0.3	0.07	8	5.5
2.5x2.5	2.80	2.80	1.55	1.5	1.75	5.5	0.9	8	4	2.0	0.3	0.07	12	9.3
2.5x3.0	2.80	3.30	1.55	1.5	1.75	5.5	0.9	8	4	2.0	0.3	0.07	12	9.3
2.5x3.5	2.80	3.80	1.55	1.5	1.75	5.5	0.9	8	4	2.0	0.3	0.07	12	9.3
2.5x4.5	2.80	4.80	1.55	1.5	1.75	5.5	0.9	8	4	2.0	0.3	0.07	12	9.3
3.5x4.5	3.90	4.80	1.55	1.5	1.75	5.5	0.9	8	4	2.0	0.3	0.07	12	9.3
2.5x3.0	2.80	3.30	1.55	1.5	1.75	5.5	0.9	8	4	2.0	0.3	0.07	12	9.3
4 x 4	4.35	4.35	1.55	1.5	1.75	5.5	1.1	8	4	2.0	0.3	0.07	12	9.3
5 x 5	5.35	5.35	1.55	1.5	1.75	5.5	1.1	8	4	2.0	0.3	0.07	12	9.3
6 x 6	6.30	6.30	1.55	1.5	1.75	7.5	1.1	12	4	2.0	0.3	0.07	16	13.3

Notes: Ao, Bo, and Ko dimensions are determined with respect to the EIA/Jedec RS-481 rotational and lateral movement requirements (see sketches A, B, and C).

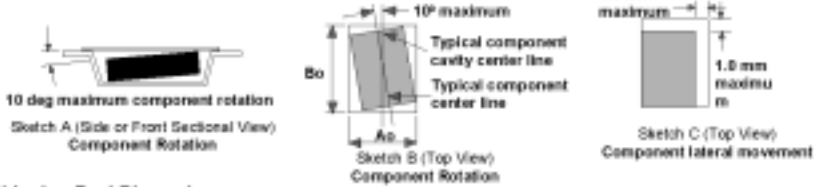

Shipping Reel Dimension

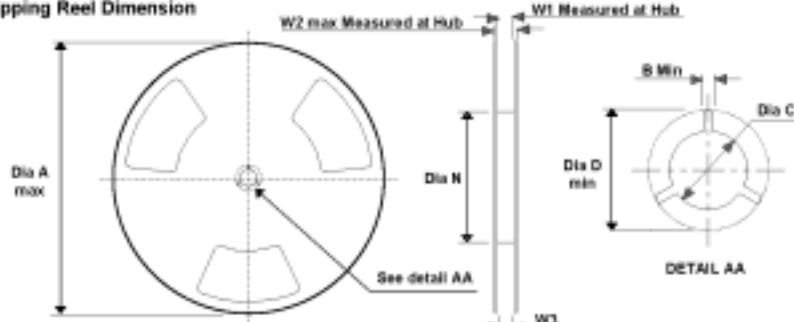

Dimensions are in millimeters

Tape Width	Dia A max	Dim B min	Dia C +5/-2	Dia D min	Dia N min	Dim W1 +2/-0	Dim W2 max	Dim W3 (LBL - USL)
8	330	1.5	13	20.2	178	8.4	14.4	7.9~10.4
12	330	1.5	13	20.2	178	12.4	18.4	11.9~15.4
16	330	1.5	13	20.2	178	16.4	22.4	15.9~19.4

Physical Dimensions inches (millimeters) unless otherwise noted

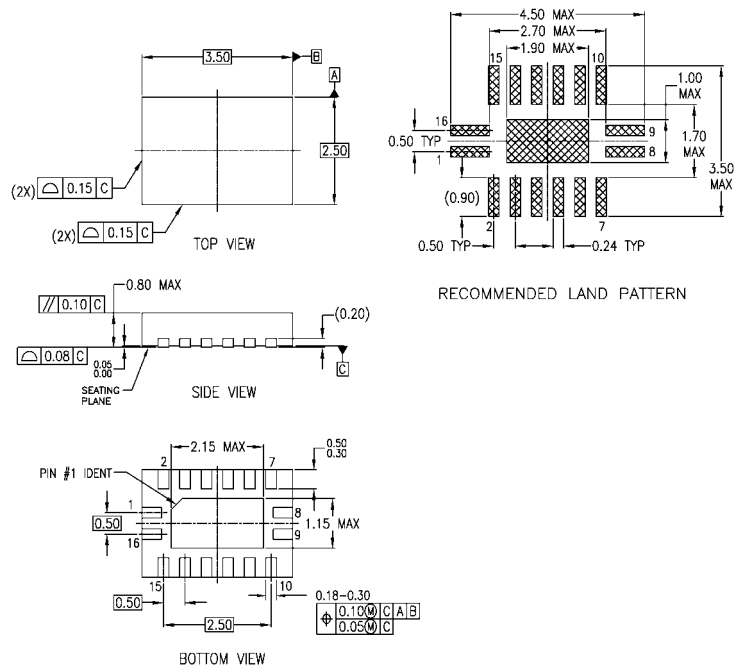

NOTES:

- A. CONFORMS TO JEDEC REGISTRATION MO-241, VARIATION AB
- B. DIMENSIONS ARE IN MILLIMETERS.
- C. DIMENSIONS AND TOLERANCES PER ASME Y14.5M, 1994

MLP016ErevA

Pb-Free 16-Terminal Depopulated Quad Very-Thin Flat Pack No Leads (DQFN), JEDEC MO-241, 2.5 x 3.5mm Package Number MLP016E

Physical Dimensions inches (millimeters) unless otherwise noted (Continued)

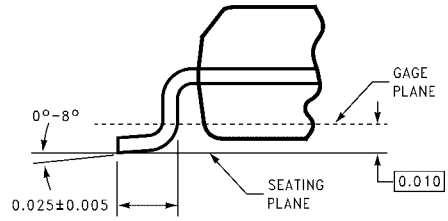
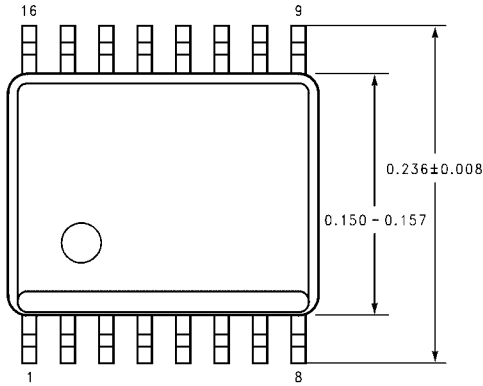

DETAIL A
TYPICAL, SCALE: 40%

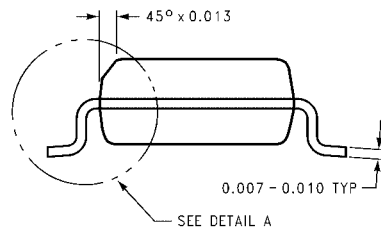
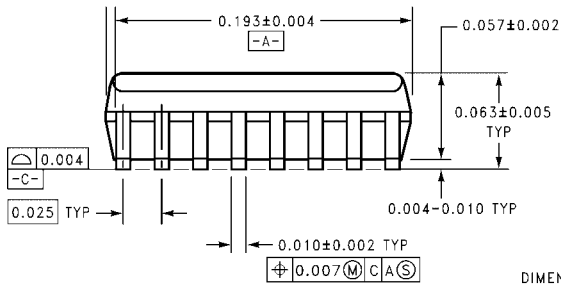

DIMENSIONS ARE IN INCHES

MQA16 (REV A)

**16-Lead Quarter Size Outline Package (QSOP), JEDEC MO-137, 0.150" Wide
Package Number MQA16**

Physical Dimensions inches (millimeters) unless otherwise noted (Continued)

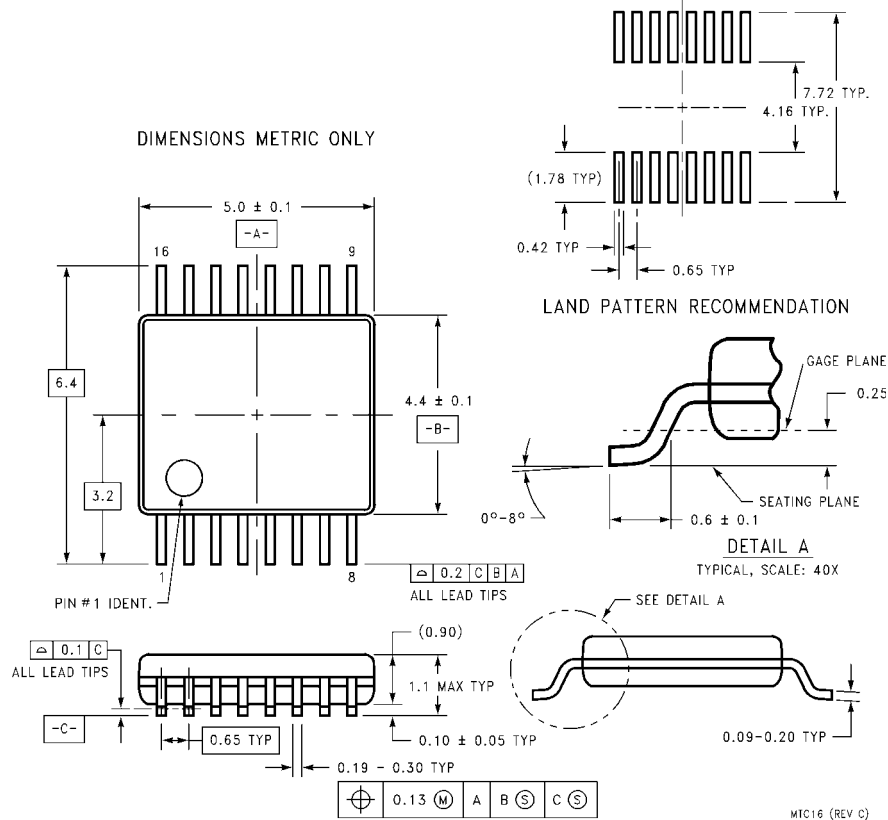

**16-Lead Thin Shrink Small Outline Package (TSSOP), JEDEC MO-153, 4.4mm Wide
Package Number MTC16**

Technology Description

The Fairchild Switch family derives from and embodies Fairchild's proven switch technology used for several years in its 74LVX3L384 (FST3384) bus switch product.

Fairchild does not assume any responsibility for use of any circuitry described, no circuit patent licenses are implied and Fairchild reserves the right at any time without notice to change said circuitry and specifications.

LIFE SUPPORT POLICY

FAIRCHILD'S PRODUCTS ARE NOT AUTHORIZED FOR USE AS CRITICAL COMPONENTS IN LIFE SUPPORT DEVICES OR SYSTEMS WITHOUT THE EXPRESS WRITTEN APPROVAL OF THE PRESIDENT OF FAIRCHILD SEMICONDUCTOR CORPORATION. As used herein:

1. Life support devices or systems are devices or systems which, (a) are intended for surgical implant into the body, or (b) support or sustain life, and (c) whose failure to perform when properly used in accordance with instructions for use provided in the labeling, can be reasonably expected to result in a significant injury to the user.
2. A critical component in any component of a life support device or system whose failure to perform can be reasonably expected to cause the failure of the life support device or system, or to affect its safety or effectiveness.

www.fairchildsemi.com