

A horizontal decorative bar consisting of a solid red rectangle on the left and a grey rectangle with horizontal lines on the right.

SH7058 Group FP-256H User System Interface Board

HS7058ECF61H User's Manual

Renesas Microcomputer Development Environment System

SuperH™ Family/SH7050 Series

User's Manual

Cautions

Keep safety first in your circuit designs!

1. Renesas Technology Corp. puts the maximum effort into making semiconductor products better and more reliable, but there is always the possibility that trouble may occur with them. Trouble with semiconductors may lead to personal injury, fire or property damage. Remember to give due consideration to safety when making your circuit designs, with appropriate measures such as (i) placement of substitutive, auxiliary circuits, (ii) use of nonflammable material or (iii) prevention against any malfunction or mishap.

Notes regarding these materials

1. These materials are intended as a reference to assist our customers in the selection of the Renesas Technology Corp. product best suited to the customer's application; they do not convey any license under any intellectual property rights, or any other rights, belonging to Renesas Technology Corp. or a third party.
2. Renesas Technology Corp. assumes no responsibility for any damage, or infringement of any third-party's rights, originating in the use of any product data, diagrams, charts, programs, algorithms, or circuit application examples contained in these materials.
3. All information contained in these materials, including product data, diagrams, charts, programs and algorithms represents information on products at the time of publication of these materials, and are subject to change by Renesas Technology Corp. without notice due to product improvements or other reasons. It is therefore recommended that customers contact Renesas Technology Corp. or an authorized Renesas Technology Corp. product distributor for the latest product information before purchasing a product listed herein. The information described here may contain technical inaccuracies or typographical errors. Renesas Technology Corp. assumes no responsibility for any damage, liability, or other loss rising from these inaccuracies or errors. Please also pay attention to information published by Renesas Technology Corp. by various means, including the Renesas Technology Corp. Semiconductor home page (<http://www.renesas.com>).
4. When using any or all of the information contained in these materials, including product data, diagrams, charts, programs, and algorithms, please be sure to evaluate all information as a total system before making a final decision on the applicability of the information and products. Renesas Technology Corp. assumes no responsibility for any damage, liability or other loss resulting from the information contained herein.
5. Renesas Technology Corp. semiconductors are not designed or manufactured for use in a device or system that is used under circumstances in which human life is potentially at stake. Please contact Renesas Technology Corp. or an authorized Renesas Technology Corp. product distributor when considering the use of a product contained herein for any specific purposes, such as apparatus or systems for transportation, vehicular, medical, aerospace, nuclear, or undersea repeater use.
6. The prior written approval of Renesas Technology Corp. is necessary to reprint or reproduce in whole or in part these materials.
7. If these products or technologies are subject to the Japanese export control restrictions, they must be exported under a license from the Japanese government and cannot be imported into a country other than the approved destination. Any diversion or reexport contrary to the export control laws and regulations of Japan and/or the country of destination is prohibited.
8. Please contact Renesas Technology Corp. for further details on these materials or the products contained therein.

Preface

The HS7058ECF61H is a user system interface board that connects a user system for the SH7058 FP-256H package to the SH7058 E6000H emulator (HS7058EPH60H).

Contents

Section 1	Configuration.....	1
Section 2	Connection Procedures	3
2.1	Connecting User System Interface Board to User System	3
2.1.1	Installing IC Socket.....	3
2.1.2	Installing IC Socket Connector	4
2.1.3	Fastening IC Socket Connector.....	5
2.2	Exchanging the Spacer of the EV-Chip Board.....	6
2.3	Connecting User System Interface Board to EV-Chip Board	7
2.4	Recommended Dimensions for User System Mount Pad (Footprint)	9
2.5	Dimensions for EV-Chip Board and User System Interface Board.....	10
2.6	Resulting Dimensions after Connecting User System Interface Board	11
Section 3	Verifying Operation.....	12
Section 4	Notice.....	14

Section 1 Configuration

Figure 1 and table 1 show the configuration and components of the user system interface board for the FP-256H package. Please make sure you have all of these components when unpacking.

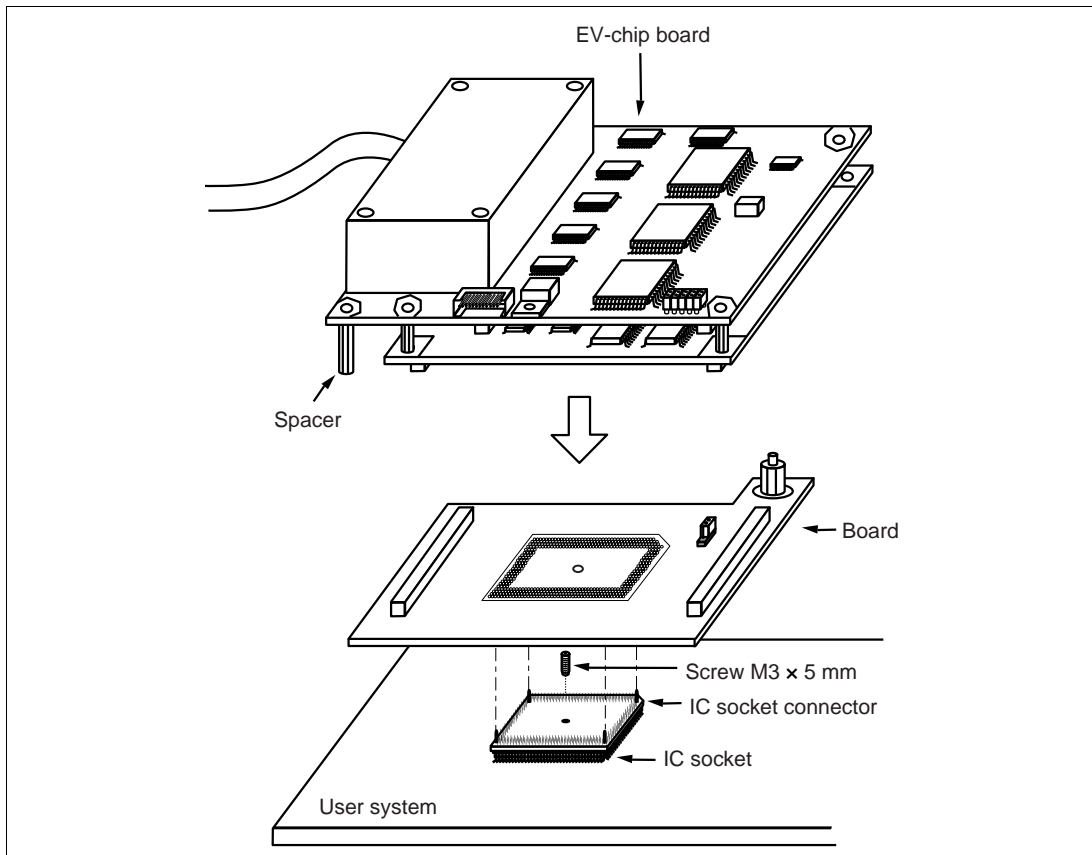

Figure 1 User System Interface Board for the SH7058 FP-256H Package

CAUTION

Use a TQPACK256RD socket and a TQSOCKET256RDP (manufactured by Tokyo Eletech Corporation) for the FP-256H package IC socket and IC socket connector on the user system.

Table 1 HS7058ECF61H Components

No.	Component	Quantity	Remarks
1	Board	1	
2	IC socket	1	For the FP-256H package (to be mounted on the user system)
3	IC socket connector	1	For the FP-256H package (for connecting the IC socket and the user system interface board)
4	Screw (M3 x 5 mm)	1	For fastening board
5	Spacers (2.6MP x 25 mm)	2	
6	User's manual	1	User's manual for HS7058ECF61H (this manual)

Section 2 Connection Procedures

2.1 Connecting User System Interface Board to User System

WARNING

Always switch OFF the user system and the emulator product before the USER SYSTEM INTERFACE BOARD is connected to or removed from any part. Before connecting, make sure that pin 1 on both sides are correctly aligned. Failure to do so will result in a FIRE HAZARD and will damage the user system and the emulator product or will result in PERSONAL INJURY. The USER PROGRAM will be LOST.

To connect the cable head to the user system, follow the instructions below.

2.1.1 Installing IC Socket

1. Solder the IC socket for an FP-256H package to the user system (figure 2).

CAUTION

Be sure to completely solder the leads so that the solder slops gently over the leads and forms solder fillets. (Use slightly more solder than the MCU.)

2. After checking the location of pin 1 on the IC socket connector and pin 1 on the IC socket, align the guide pins on the IC socket connector with the guide holes on the IC socket, and insert the IC socket connector into the IC socket (figure 2).

CAUTION

Check the location of pin 1 before inserting.

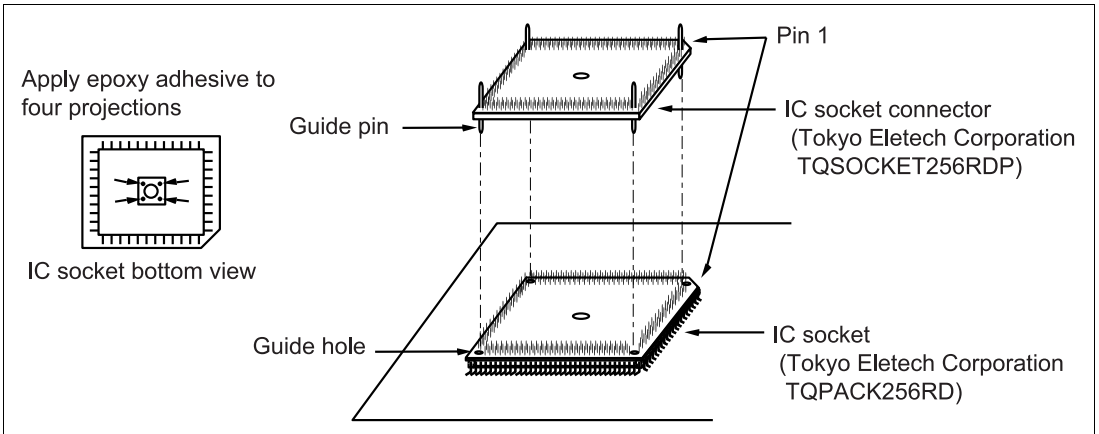

Figure 2 Installing IC Socket to User System

2.1.2 Installing IC Socket Connector

CAUTION

Check the location of pin 1 before inserting.

After checking the location of pin 1 on the user system interface board and pin 1 on the IC socket connector, align the guide pins on the IC socket connector with the guide holes on the user system interface board, and insert the IC socket connector into the IC socket (figure 3).

2.1.3 Fastening IC Socket Connector

CAUTION

1. Use a hexagonal wrench (ϕ 1.5 mm).
2. Stop tightening when the force required to turn the screw becomes significantly greater than that needed when first tightening. If a screw is tightened too much, the screw head may break or an IC socket contact error may be caused by a crack in the IC socket solder.
3. If the emulator does not operate correctly, cracks might have occurred in the solder. Check conduction with a tester and re-solder the IC socket if necessary.

Fasten the user system interface board to the IC socket and the IC socket connector on the user system with the screw (M3 x 5 mm) provided.

Take special care, such as manually securing the IC socket soldered area, to prevent the soldered IC socket from being damaged by twisting the components.

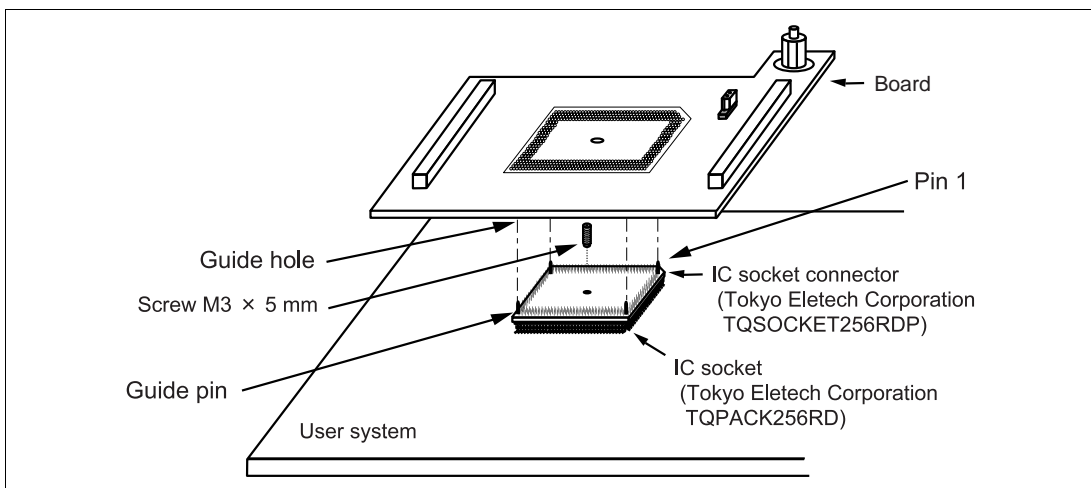

Figure 3 Connecting User System Interface Board to User System

2.2 Exchanging the Spacer of the EV-Chip Board

While the user system interface board is connected to the user system, force must not applied to the user system.

Exchange the spacer (2.6MP x 10 mm) of the EV-chip board with another spacer (2.6MP x 25 mm) provided for the user system interface board.

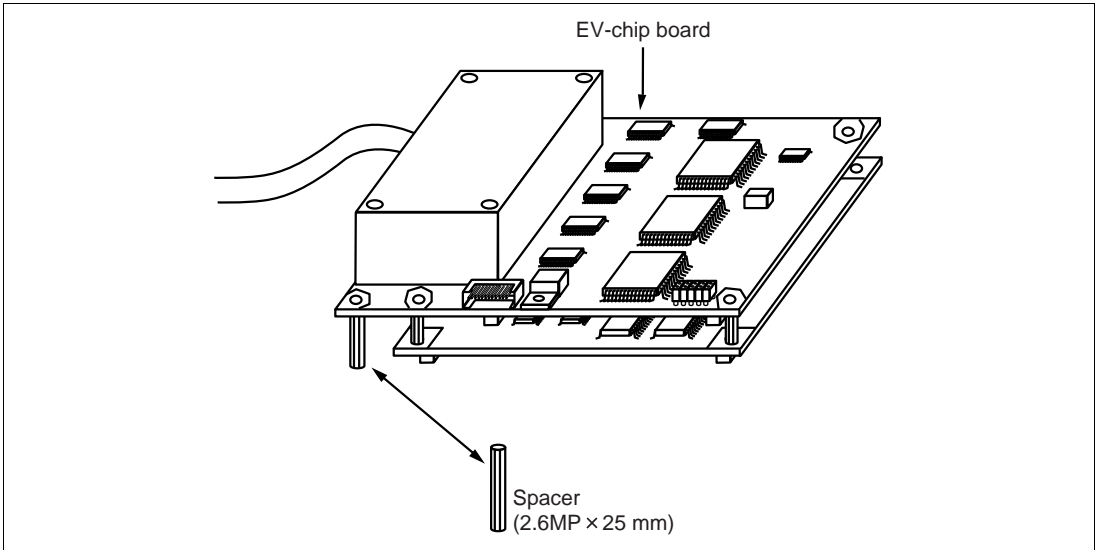

Figure 4 Exchanging the Spacer

2.3 Connecting User System Interface Board to EV-Chip Board

WARNING

Observe the precautions listed below. Failure to do so will result in a FIRE HAZARD and will damage the user system and the emulator product or will result in PERSONAL INJURY. The USER PROGRAM will be LOST.

- 1. Always switch OFF the user system and the emulator product before the USER SYSTEM INTERFACE BOARD is connected to or removed from any part. Before connecting, make sure that pin 1 on both sides are correctly aligned.**
- 2. The user system interface board dedicated to the emulator must be used.**

1. Make sure the user system and emulator are turned off.
2. Align the connectors on the board with those on the EV-chip board according to their numbers (figure 5).
3. Adjust the height of the spacer of the EV-chip board with the user system.

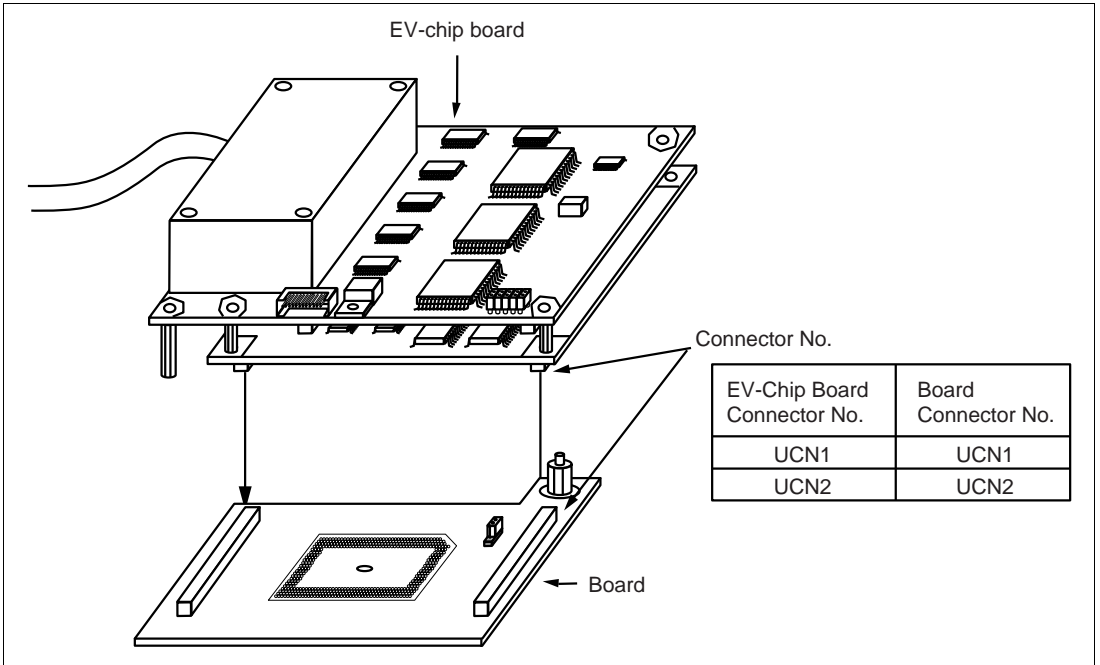

Figure 5 Connecting User System Interface Board to EV-Chip Board

2.4 Recommended Dimensions for User System Mount Pad (Footprint)

Figure 6 shows the recommended dimensions for the mount pad (footprint) for the user system with an IC socket for an FP-256H package (TQPACK256RD: manufactured by Tokyo Eletech Corporation). Note that the dimensions in figure 6 are somewhat different from those of the actual chip's mount pad.

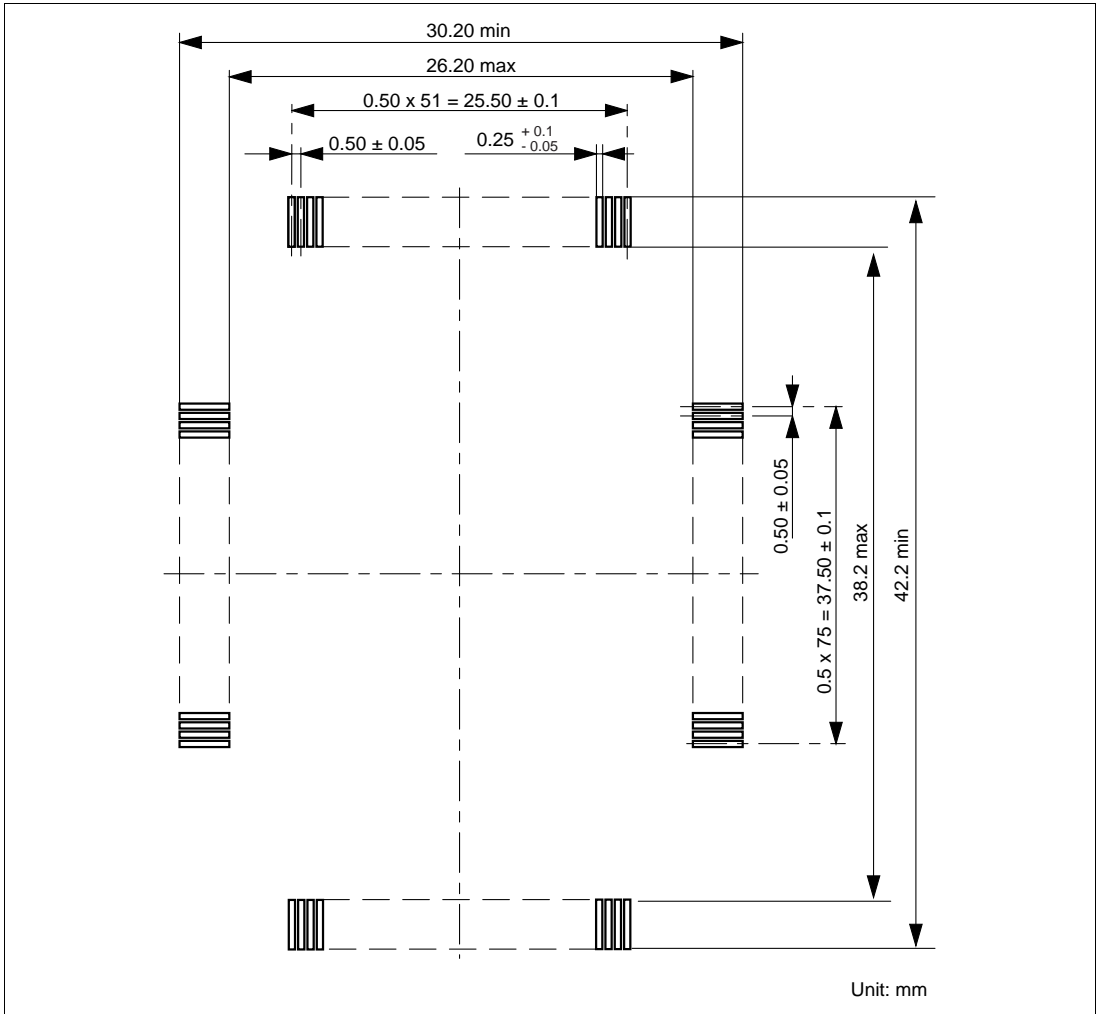

Figure 6 Recommended Dimensions for Mount Pad

2.5 Dimensions for EV-Chip Board and User System Interface Board

The dimensions for the EV-chip board and the user system interface board are shown in figure 7.

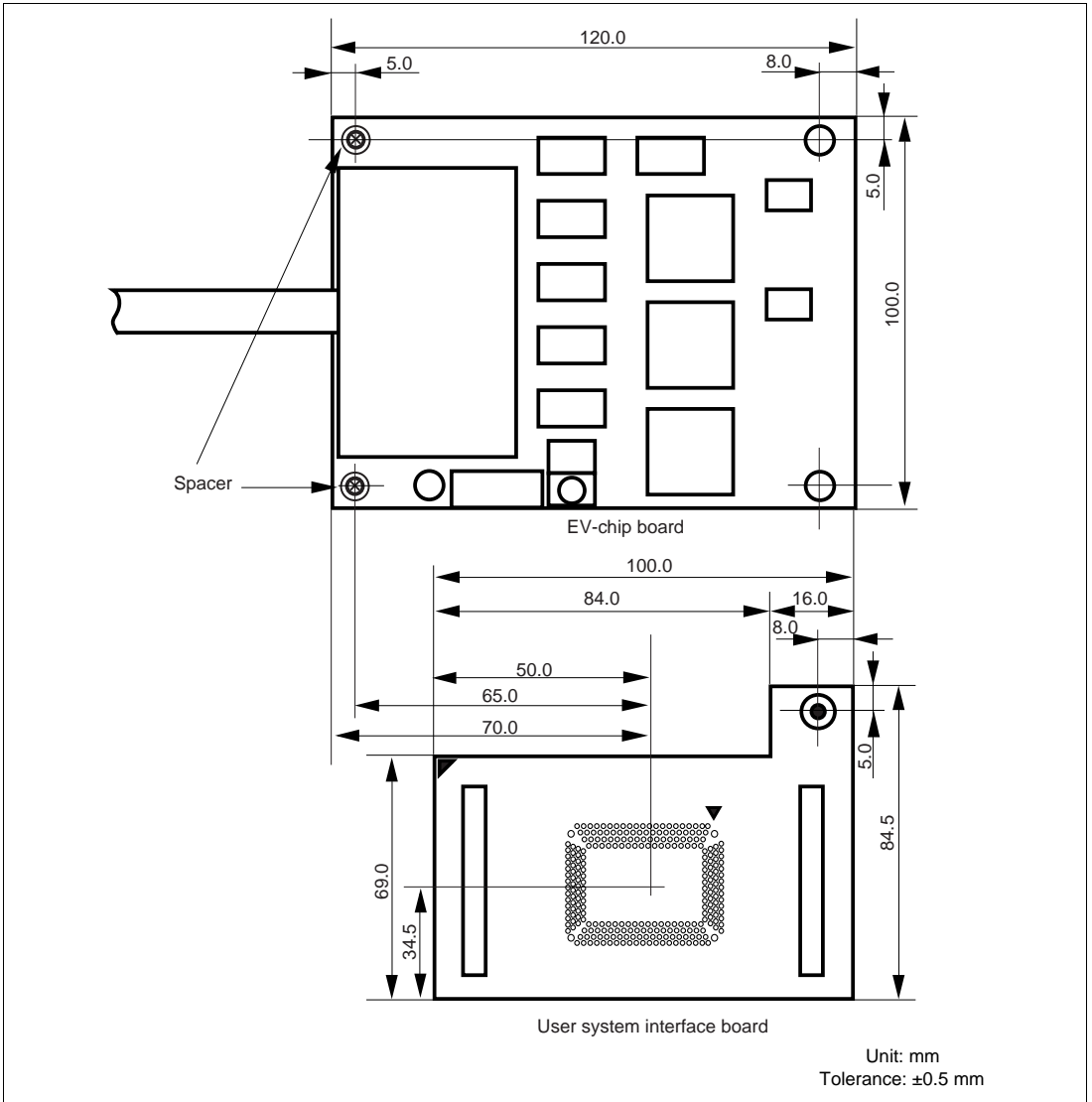

Figure 7 Dimensions for EV-Chip Board and User System Interface Board

2.6 Resulting Dimensions after Connecting User System Interface Board

The resulting dimensions, after connecting the user system interface board to the user system, are shown in figure 8.

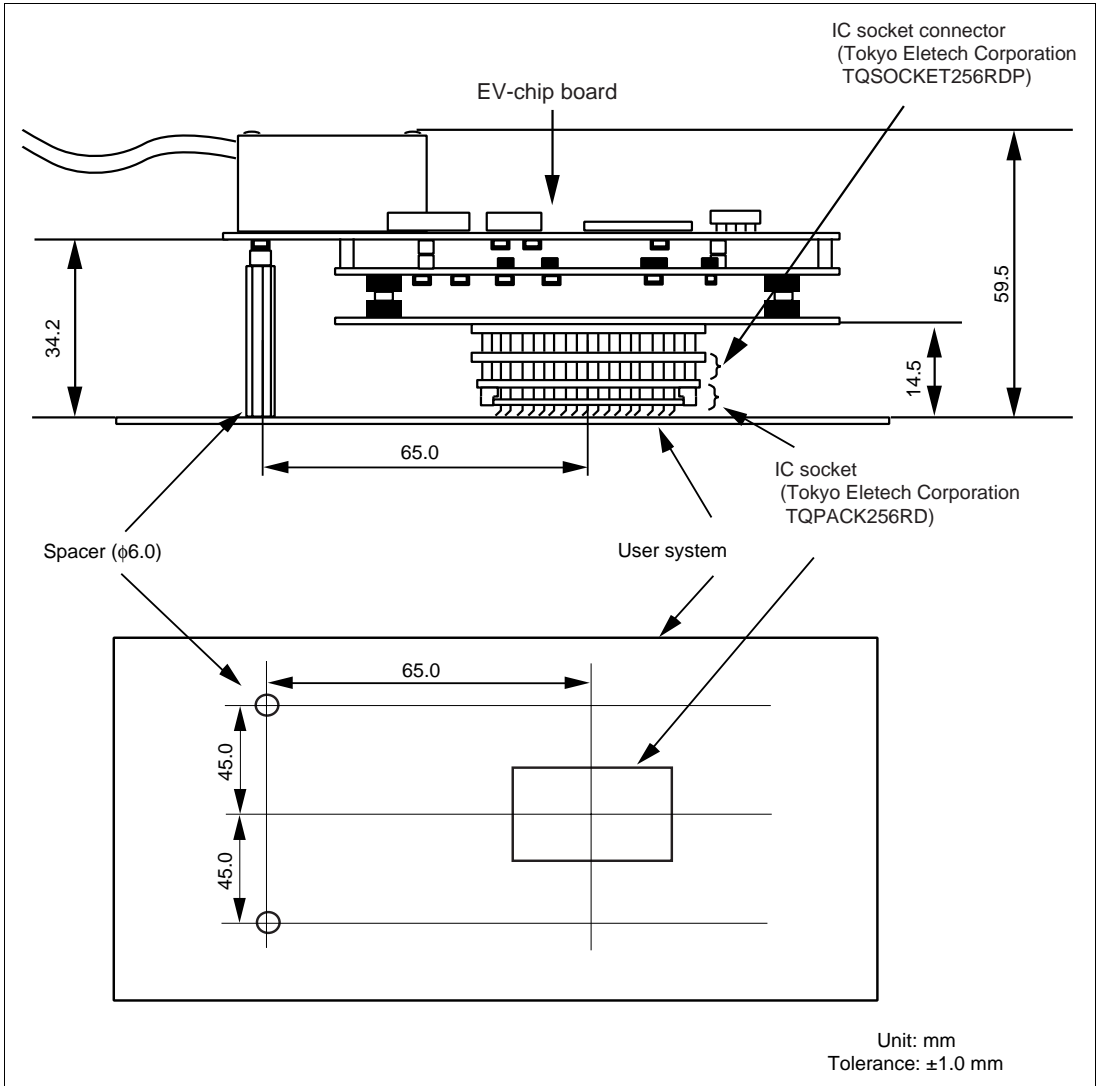

Figure 8 Resulting Dimensions after Connecting User System Interface Board

- To use the crystal oscillator mounted on the EV-chip board
Install a crystal oscillator into the crystal oscillator terminals on the EV-chip board.

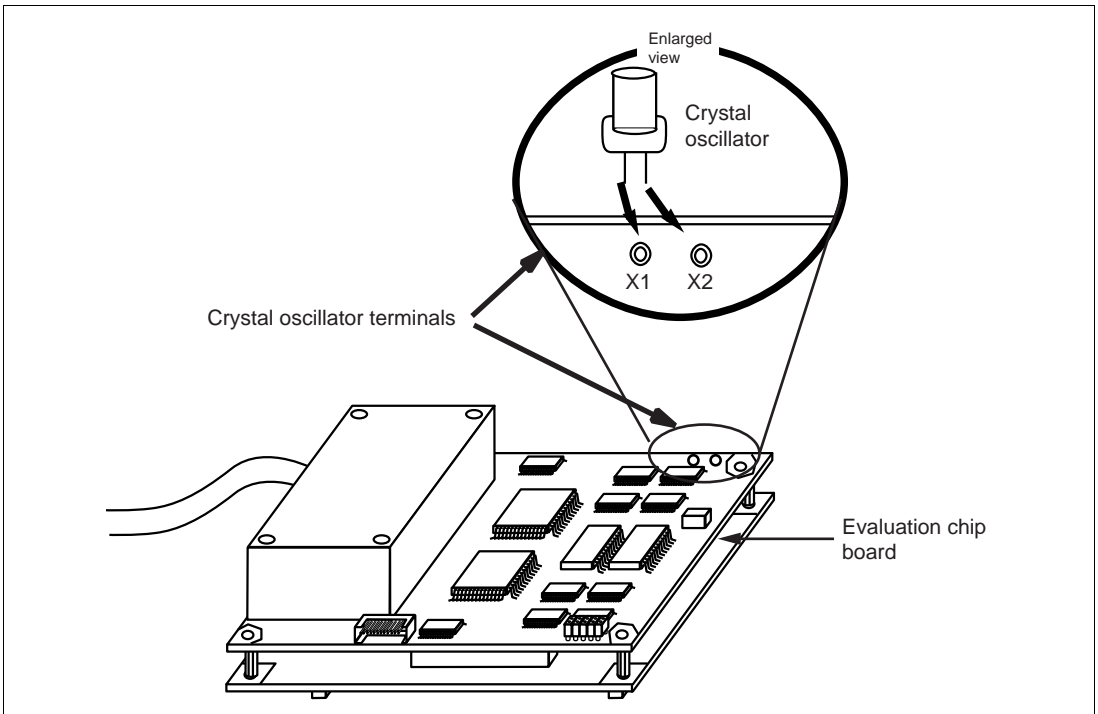

Figure 10 Installing the Clock Oscillator

Section 4 Notice

1. The MCU cannot be installed directly into the IC socket provided for connecting this user system interface board.
2. Before connecting any parts or cables, make sure that pin 1 on the both sides are correctly aligned.
3. Do not apply excessive force to the user system interface board while it is connected to the user system.
4. The dimensions of the recommended mount pad for the IC socket for this user system interface board are different from those of the MCU.
5. This user system interface board is specifically designed for the HS7058EPH60H emulator. Do not use this board with any other emulator.
6. When power is not supplied to the Vcc pin on the user system interface board, the emulator displays ** VCC DOWN. The emulator will not operate correctly.

SH7058 Group FP-256H
User System Interface board
HS7058ECF61H User's Manual

Publication Date: Rev.6.00, January 29, 2004

Published by: Sales Strategic Planning Div.
Renesas Technology Corp.

Edited by: Technical Documentation & Information Department
Renesas Kodaira Semiconductor Co., Ltd.

SH7058 Group FP-256H
User System Interface Board
HS7058ECF61H User's Manual



Renesas Technology Corp.

2-6-2, Ote-machi, Chiyoda-ku, Tokyo, 100-0004, Japan

REJ10B0089-0600H