

Performance Parameters 1MC06-103-XX

Type	ΔT_{max} K	Q_{max} W	I_{max} A	U_{max} V	AC R Ohm	H mm	h mm
1MC06-103-xx (N=103)							
1MC06-103-05	69	23.3	3.4	12.7	3.00	1.6	0.5
1MC06-103-08	71	15.2	2.2		4.75	1.9	0.8
1MC06-103-10	71	12.4	1.8		5.95	2.1	1.0
1MC06-103-12	72	10.4	1.5		7.10	2.3	1.2
1MC06-103-15	72	8.4	1.2		8.85	2.6	1.5

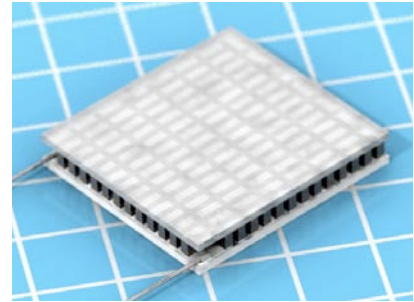

Performance data are given at 300K, vacuum

Technical Drawing

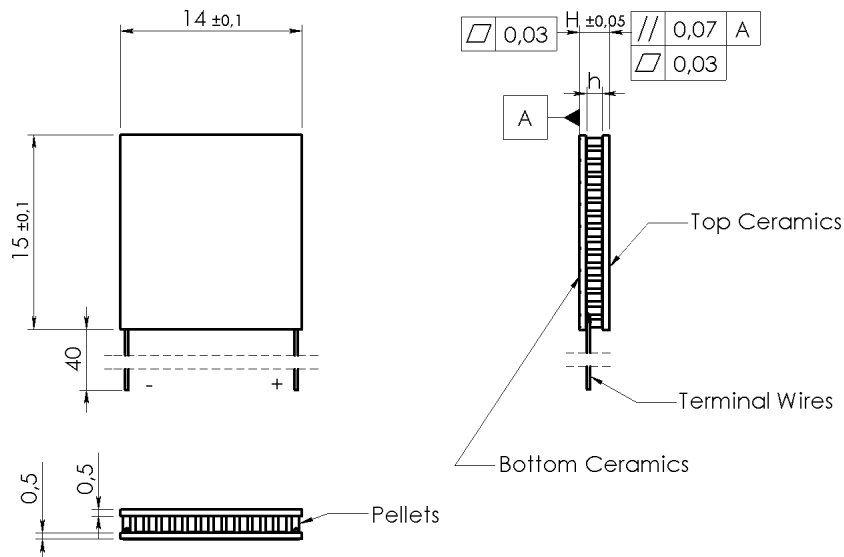

Options available

A. TEC Assembly:

Solder SnSb (Tmelt=230°C)

B. Ceramics:

1. Pure Al₂O₃ (100%)
2. Alumina (Al₂O₃- 96%)
3. Aluminum Nitride (AlN)

100% Al₂O₃ used as standard

C. Ceramics Surface Options

1. Blank ceramics
2. Metallized:
 - 2.1 Ni / Sn(Bi)
 - 2.2 Gold plating
3. Metallized and pre-tinned:
 - 3.1 Solder 94 (PbSnBi, Tmelt=94°C)
 - 3.2 Solder 117 (In-Sn, Tmelt=117°C)
 - 3.3 Solder 138 (Sn-Bi, Tmelt=138°C)
 - 3.4 Solder 183 (Pb-Sn, Tmelt=183°C)

D. Thermistor (optional)

Can be mounted to cold side ceramics edge. Calibration is available.

E. Terminal wires

1. Pre-tinned Copper
2. Insulated Wires
3. Insulated Color Coded

Performance Plots

1MC06-103-05

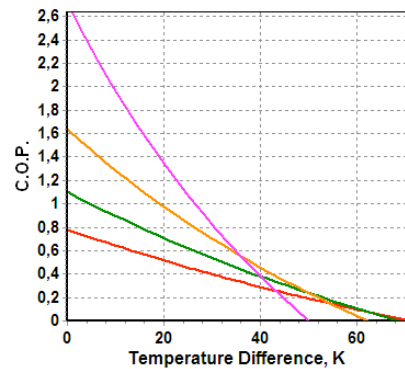
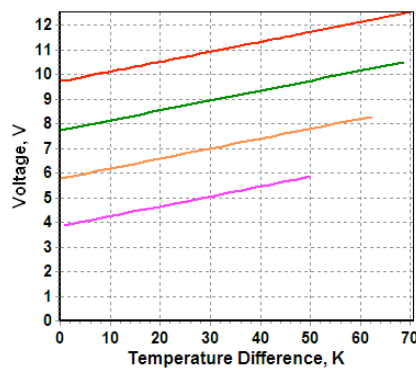
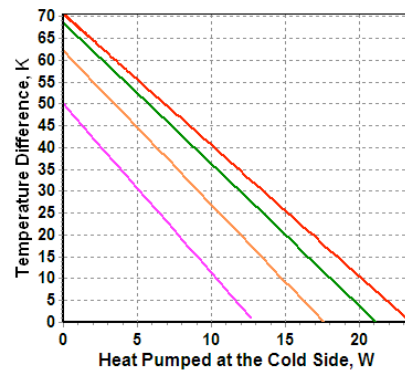
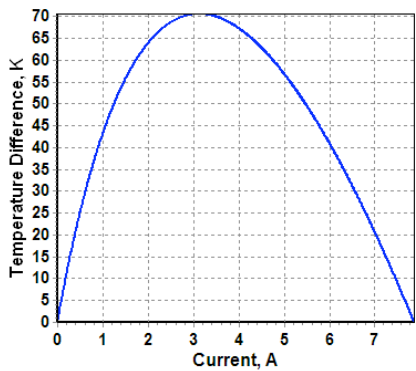

Performance Plots

1MC06-103-08

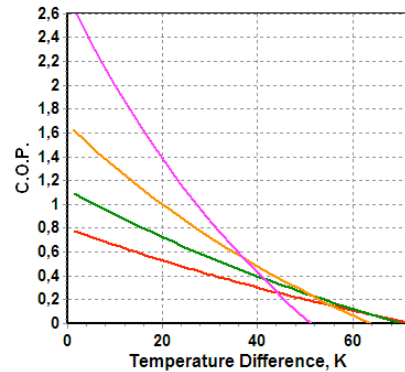
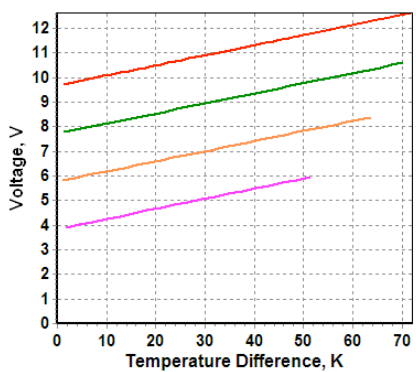
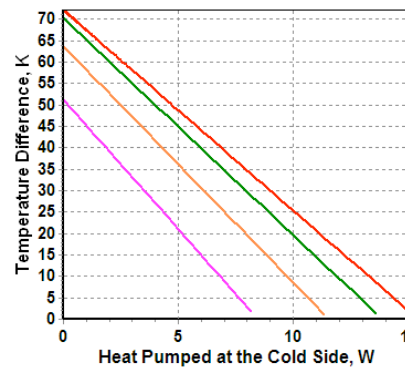
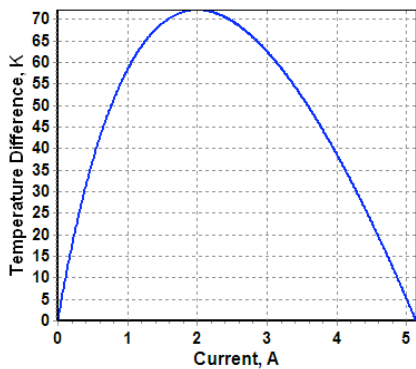

Color Legend: I_{max}, 0.8 I_{max}, 0.6 I_{max}, 0.4 I_{max}

Performance Plots

1MC06-103-10

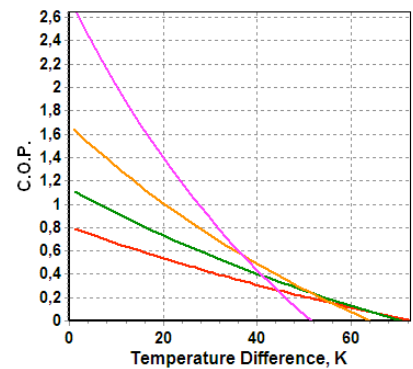
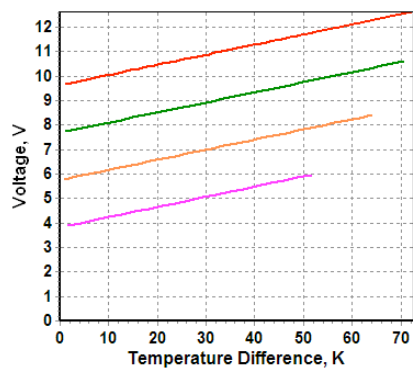
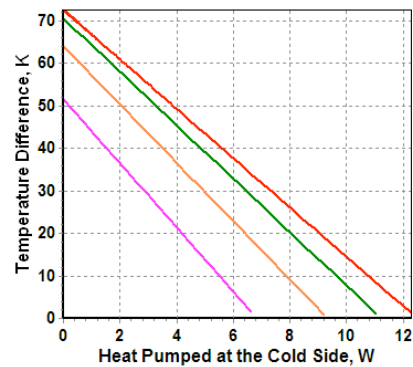
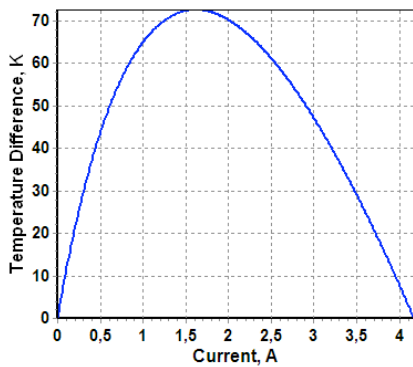

Performance Plots

1MC06-103-12

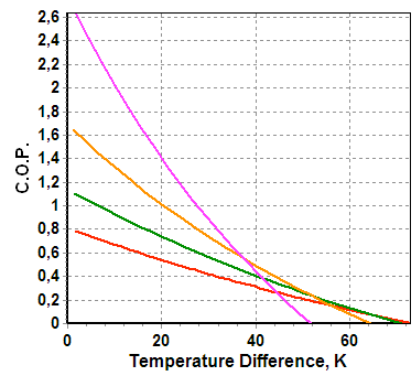
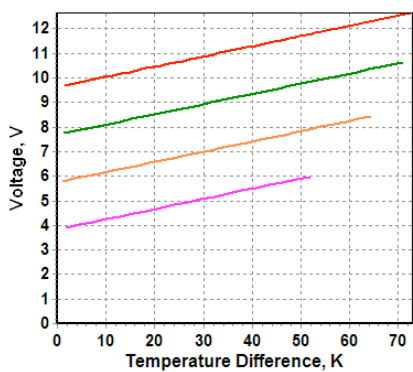
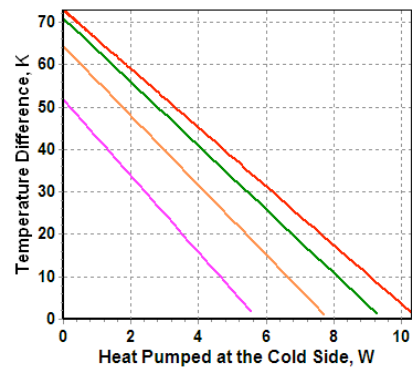
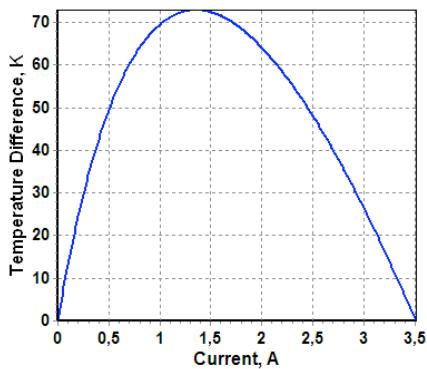

Color Legend: I_{max} , $0.8 I_{max}$, $0.6 I_{max}$, $0.4 I_{max}$

Performance Plots

1MC06-103-15

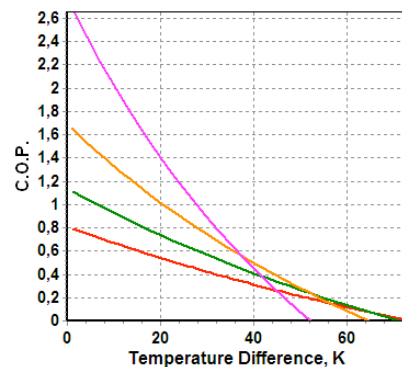
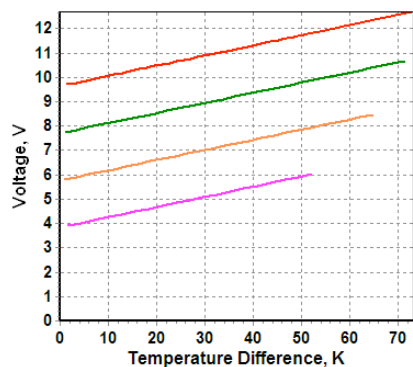
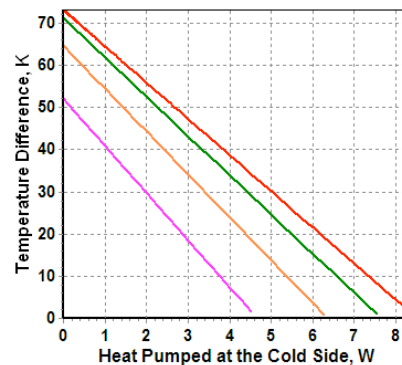
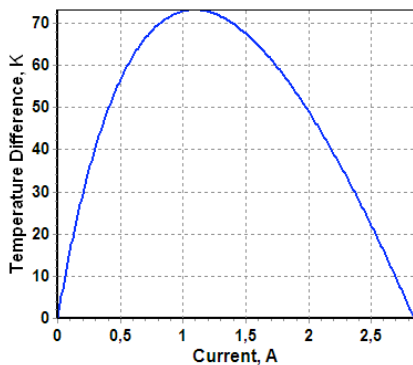

Color Legend: I_{max} , $0.8 I_{max}$, $0.6 I_{max}$, $0.4 I_{max}$

Application Tips

1. Never heat TE module more than 200°C (TEC assembled at 230°C).
2. Never use TE module without attached heat sink at hot (bottom) side.
3. Connect TE module to DC power supply according to polarity.
4. Do not apply DC current higher than I_{max} .

Installation

1. **Mechanical Mounting.** TEC is placed between two heat exchangers. This construction is fixed by screws or in another mechanical way. It is suitable for large modules (with dimensions 30x30mm and larger). Miniature types require other assembling methods in most cases.
2. **Soldering.** This method is suitable for a TE module with metallized outside surfaces. RMT provides this option and also makes pre-tinning for TE modules.
3. **Gluing.** It is an up-to-date method that is used by many customers due to availability of glues with good thermoconductive properties. A glue is usually based on some epoxy compound filled with some thermoconductive material such as graphite or diamond powders, silver, SiN and others. The application of a specific type depends on application features and the type of a TE module.

